

BR08U

Crossarm



PROJECT:

TYPE:

Description

The BR08U Series cross arms feature a strong yet lightweight design for ease of installation. The series can accommodate a wide variety of fixtures. It is designed to be used on a pole with a min. 4" OD shaft.

Construction

Crossarms are shipped as a one piece unit as shown. Crossarms are constructed from ASTM 319 aluminum. Exterior hardware is stainless steel and tamper resistant.

Installation

Crossarms will slip fit a 3" OD post top tenon and attach with two rows of 5/16" dia. set screws.

Set screws will be cone pointed and stainless steel. Crossarms and wall brackets are equipped with 3" O.D. tenons for luminaire mounting.

The wall bracket is constructed of corrosion resistant cast aluminum (A319 Alloy). It has a nominal 3"OD tenon for luminaire mounting, and four holes in the back plate for mounting to the wall. (Wall mounting hardware is not included, due to the wide variety of backing materials. Customer should determine the appropriate anchoring hardware based on the wall material.)

Finish

The bracket will be finished with a premium quality thermoset polyester powdercoat for a durable finish.

- BLK** - Satin Black
- CLB** - Classic Bronze
- GBZ** - Gloss Textured Bronze
- GRN** - Green
- GTB** - Gloss Textured Black
- TBK** - Textured Black
- TGR** - Gloss Textured Green

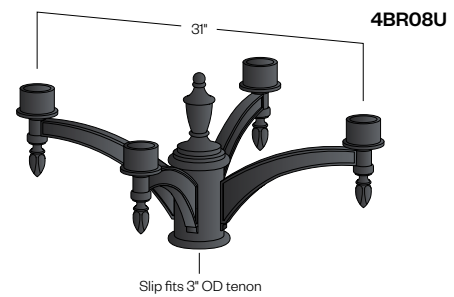
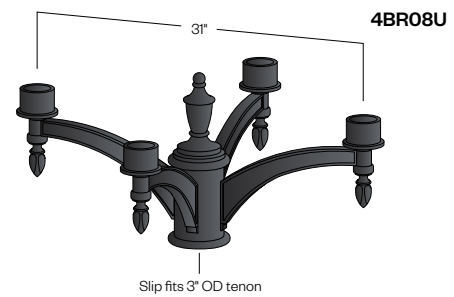
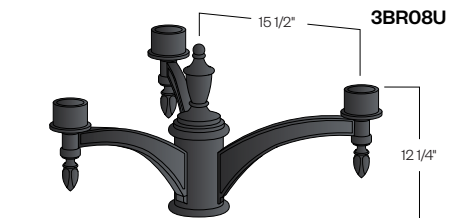
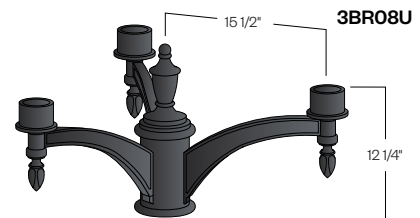
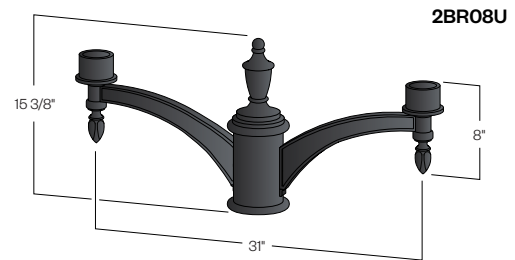

Center extension is also available with the two and three bracket crossarms (specify "-C" in the ordering guide).

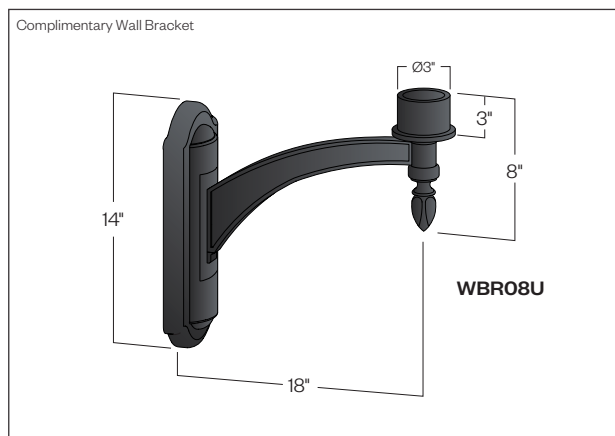
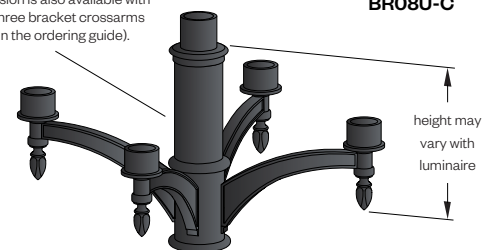

Model	Finish
2BR08U	BLK,CLB
3BR08U	GBZ,GRN
4BR08U	GTB,TBK
4BR08U-C	TGR
WBR08U	

Ordering options in **BOLD**