

Avista LED Light Engine Retrofit Guide

The Avista (AVI2) is a high powered, durable LED light engine that will work with many luminaires on the market today. This guide addresses the common issues of qualifying the job and getting the required fixture information to create a simple field installation solution for the end user.

With some basic knowledge of how the AVI2 works, the decision makers and installers can pre-qualify and choose the right AVI2 model for the luminaire.



Diversity is the name of the game.

By design, Avista has the capacity to retrofit some of the most challenging luminaires in the lighting industry. HID luminaires were not designed to use technology 10 to 20 years advanced from when it was originally manufactured. However, Amerlux has come up with a “skeleton key” of sorts to fit as many applications as possible. With just basic information about your retrofit idea, Avista can be the solution to providing a dramatic improvement in quality of lighting and extend the lifespan of the luminaire.

Some of Avista's retrofit experience:

Holophane
Hadco
King

Louis Poulsen
Lumec
Pemco

Sternberg
Visco

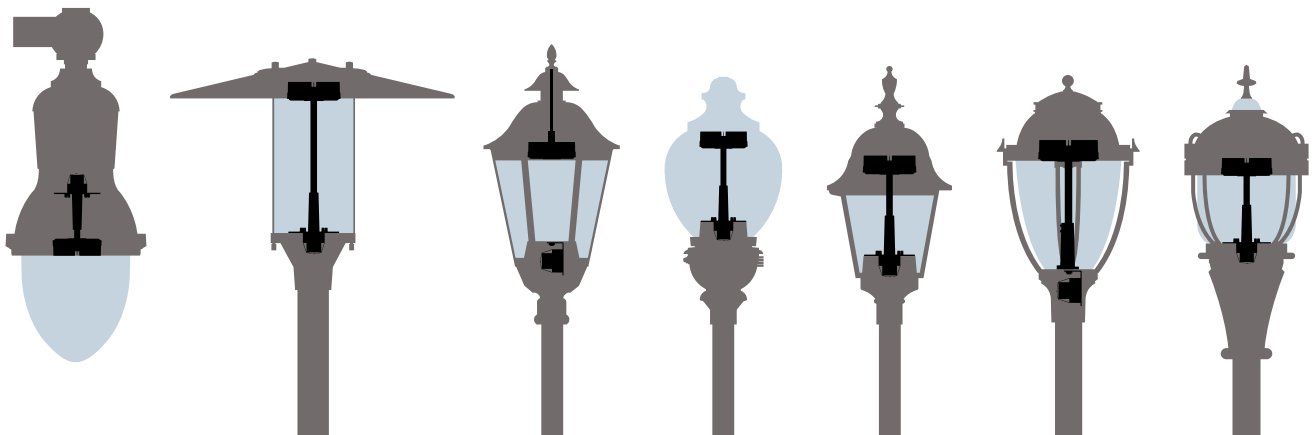

Typical AVI2-U Mounting

The AVI2-U model Avista LED engine is designed for the purpose of retrofitting many post-top luminaires where the LED engine is stem-mounted above the driver assembly.

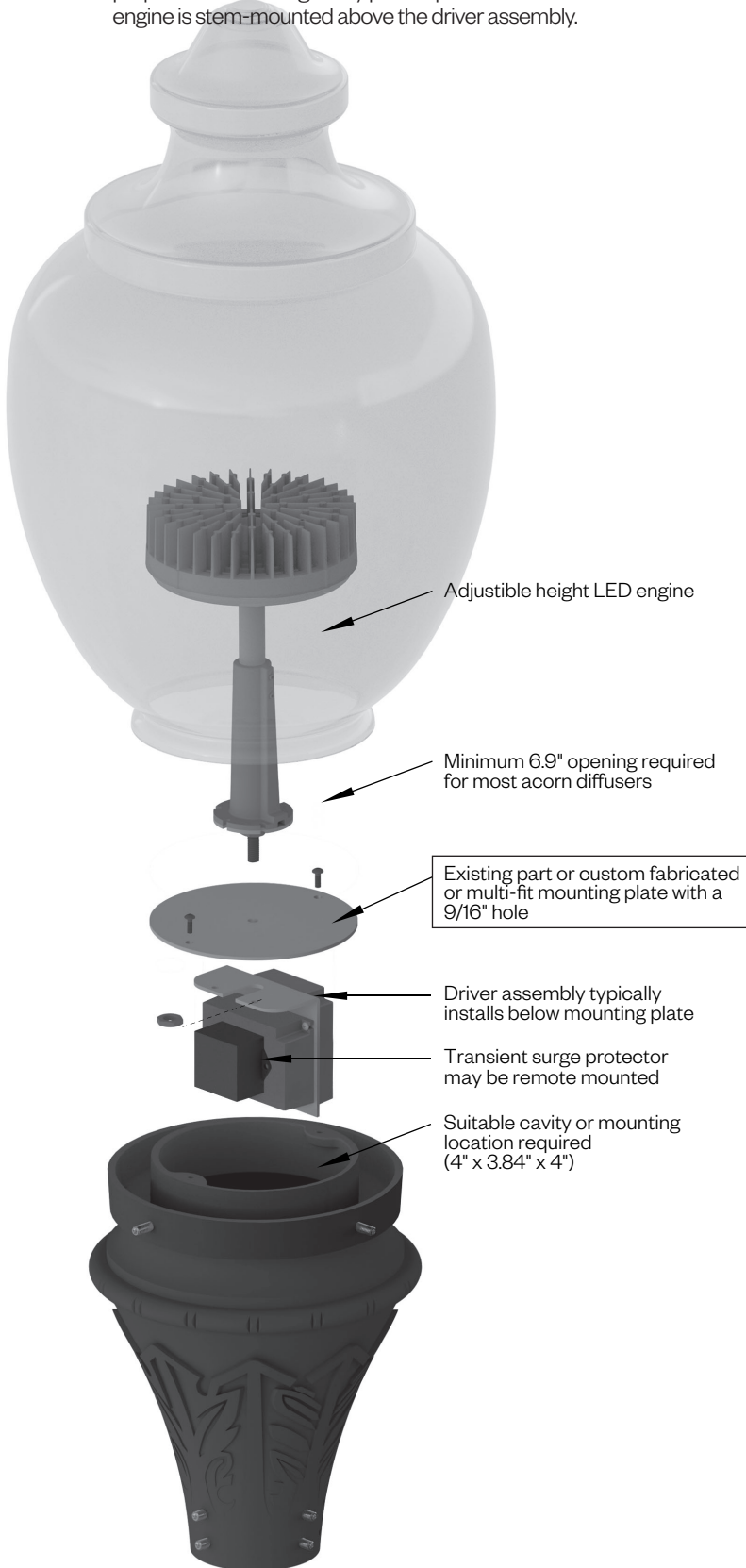

Mounting Checklist:

Suitable Mounting Location

- A suitable location or existing mounting plate with a minimum 9/16" hole
or
- A multi-fit, or custom fabricated mounting plate designed for the specific luminaire (contact factory)
- A minimum 6.9" opening required to allow the Avista clearance into the diffuser
- A suitable cavity or mounting location for driver assembly (4" x 3.84" x 4" required)

Optional AVI-U Mounting Plates

Multi-fit

Allows for various screw patterns and configurations.

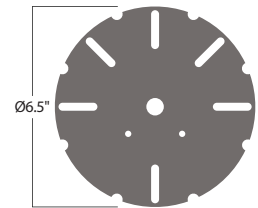

Custom Mounting Plates (contact factory)

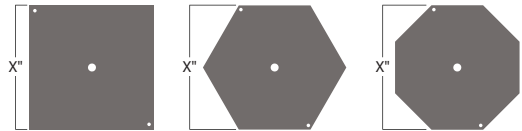

Driver Assembly

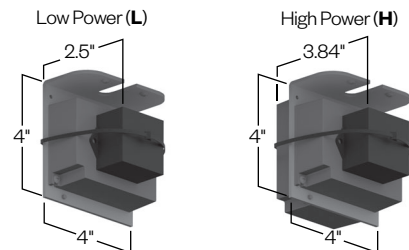

AVI2-U accommodates a variety of applications.

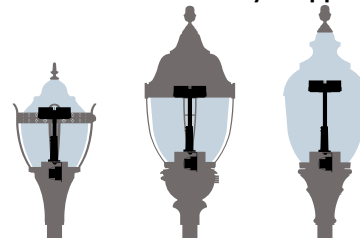

Typical AVI2-P Mounting

The AVI2-P model Avista LED engine is designed for use in pendant mount applications. It is suitable for use in a variety of luminaires from teardrops to bell shaped fixtures, or in lanterns when no visible post is desired.

Pendant kit includes

- 20" of leads between light engine and driver assembly
- 1/4"-20 all-thread mounting hardware
- 1/4" IPS mounting hardware

Pendant configurations utilize a custom mounting plate, bracket, or mounting locations often found in lighting fixtures.

LED engine

Transient surge protector may be remote mounted

Driver assembly can be mounted in a suitable cavity. (shown mounted below driver)

Mounting Checklist:

Suitable Mounting Location

- A suitable pendant mounting plate or bracket with a minimum 9/16" hole or
- A suitable pendant mounting plate or bracket with a minimum 5/16" hole or
- A custom fabricated mounting plate designed for the specific luminaire (contact factory)

- Driver cavity above light engine or
- Driver cavity below light engine (20" wire provided)

- A suitable cavity or mounting location for driver assembly (4" x 3.84" x 4" required)

Optional AVI2-P Mounting Plates

Multi-fit

Allows for various screw patterns and configurations.

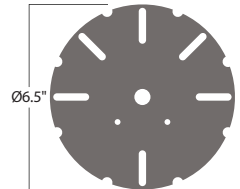

Custom Mounting Plates (contact factory)

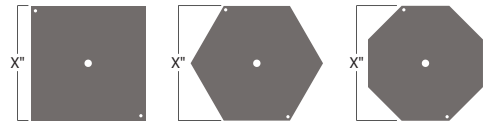

Driver Assembly

Low Power (L)

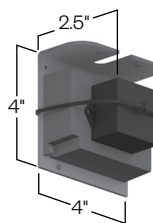

High Power (H)

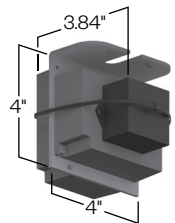

AVI2-P accommodates a variety of applications.

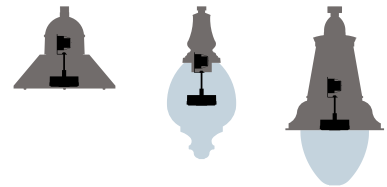

Driver shown installed above light engine

Standard Models

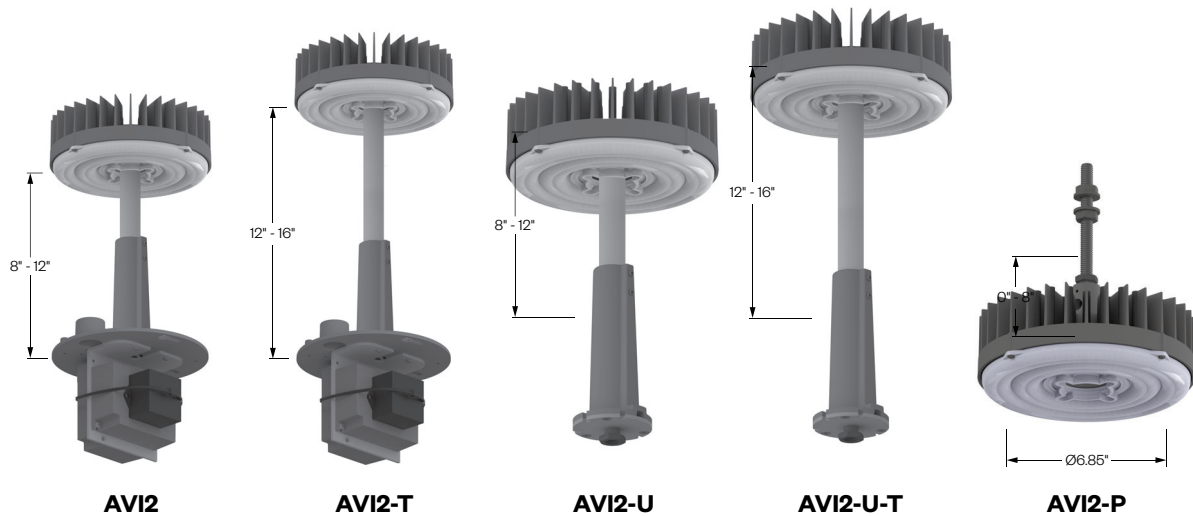

Light Distribution Types

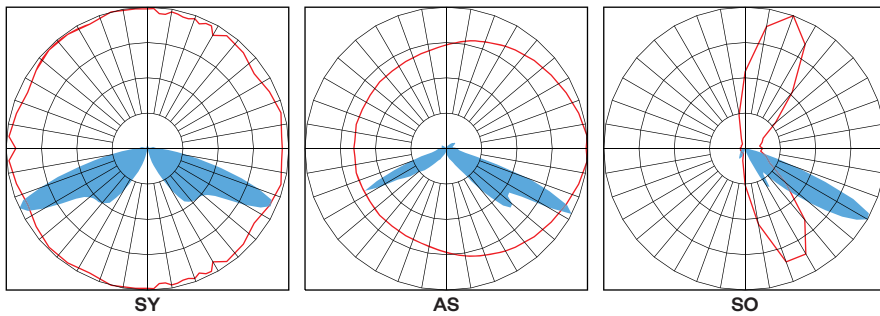

How To Order

Step 1

Choose a Model that best suits your retrofit project.

Step 2

Choose a Light Distribution

Step 3

Choose a Code that represents the wattage and lumens desired.

Step 4 (Optional Accessory)

Choose a mounting plate if needed.

Model	Driver Output	System Watts	Light Distribution	CCT	Engine Only Lumens	Engine Only LPW	DLC Globe Lumens	DLC Globes LPW
AVI2 (Standard model) AVI2-T (Tall model) AVI2-U (Multi-fit model) AVI2-U-T (Multi-fit Tall model) AVI2-P (Pendant model)	500M (500mA)	27W	SY (Symmetric)	27 (2,700K)	3,030 lm	112	2,270 lm	84
				30 (3,000K)	3,120 lm	116	2,880 lm	107
				40 (4,000K)	3,420 lm	126	3,150 lm	117
			AS (Asymmetric)	27 (2,700K)	2,910 lm	108	2,200 lm	81
				30 (3,000K)	3,000 lm	111	2,770 lm	103
				40 (4,000K)	3,140 lm	116	2,900 lm	107
			SO (Street Optic)	27 (2,700K)	2,980 lm	110	2,440 lm	82
				30 (3,000K)	3,060 lm	113	2,830 lm	105
				40 (4,000K)	3,220 lm	119	2,980 lm	110
	700M (700mA)	38W	SY (Symmetric)	27 (2,700K)	4,120 lm	109	3,100 lm	81
				30 (3,000K)	4,240 lm	112	3,870 lm	103
				40 (4,000K)	4,640 lm	123	4,240 lm	112
			AS (Asymmetric)	27 (2,700K)	3,790 lm	100	2,990 lm	60
				30 (3,000K)	3,900 lm	103	3,610 lm	96
				40 (4,000K)	4,090 lm	108	3,780 lm	100
			SO (Street Optic)	27 (2,700K)	4,010 lm	106	3,290 lm	86
				30 (3,000K)	4,130 lm	109	3,820 lm	101
				40 (4,000K)	4,330 lm	115	4,010 lm	106
1200M (1200mA)	68W	SY (Symmetric)	27 (2,700K)	6,110 lm	90	*	*	
			30 (3,000K)	7,260 lm	107	6,720 lm	99	
			40 (4,000K)	7,530 lm	111	6,970 lm	103	
		AS (Asymmetric)	27 (2,700K)	5,690 lm	84	*	*	
			30 (3,000K)	6,990 lm	103	6,470 lm	96	
			40 (4,000K)	7,320 lm	108	6,770 lm	100	
		SO (Street Optic)	27 (2,700K)	5,820 lm	86	*	*	
			30 (3,000K)	7,140 lm	106	6,610 lm	98	
			40 (4,000K)	7,500 lm	111	6,940 lm	103	

Ordering options in BOLD (Example: **AVI2-SY-27-500M**)

*These models are not DLC listed.