

COACH STYLE LANTERN

POST-TOP-MOUNT

U.11.8.18

CSL-P
LED

DESCRIPTION:

The **CSL-P** luminaire is a classically styled post-top lantern that offers a choice of several optical systems.

CONSTRUCTION:

Die-cast aluminum housing ensures rigidity and longevity in application. The rooftop casting is hinged to the cage and utilizes tool-less hardware for ease of installation and maintenance.

OPTICAL MODULE:

The luminaire utilizes up to four IP66 sealed optical modules consisting of a high performance LED board with an acrylic (TIR) lens to deliver maximum spacing and uniformity. A choice of Type 2 (**T2**), Type 3 (**T3**), Type 4 (**T4**), or Type 5 (**T5**), IES distributions are available with the scalability to meet application criteria. Custom configurations available.

ELECTRICAL:

- 12 LEDs per module
- LED Board Drive Current 530mA (Custom drive currents available)
- Universal input voltage 120-277 VAC (50/60Hz)
- Operational Temp: -40°C/40°C
- Power consumption up to 79W
- Series wired 20kV/10kA surge protector (Per ANSI C82.77-5-2015)
- 0-10V dimming is standard
- A 347V/480V option is available
- DLC listed

PHOTO CONTROL:

- A 3-pin twistlock photocell receptacle is standard.
- An optional rotatable 7-pin (**7P**) twistlock photocell receptacle is available.
- The 3-pin Twistlock photocell is an accessory and must be specified (**TW-PCL**).

FINISH:

Durable thermoset polyester powdercoat finish in the following:

- Textured Black (**TBK**)
- Classic Bronze (**CLB**)
- Gloss Textured Bronze (**GBZ**)
- Gloss Textured Black (**GTB**)

MOUNTING:

Slip fits Ø3" tenon

LIGHT DISTRIBUTION:

- Type II (**T2**)
- Type III (**T3**)
- Type IV (**T4**)
- Type V (**T5**)

CCT:

- 3,000K (**3K**)
- 4,000K (**4K**)

OPTIONAL LENS:

- Textured Acrylic (**TA**)

ACCESSORIES:

- Bird Guard (**BG**)
- Backlight Shield (**BLS**) Type II and Type III dist.
- Twistlock Photocell (**TW-PCL**)

EPA: 1.61

(2.77 with optional lens)

Approx. Luminaire Wt: 18lb (8.1kg)

Approx. Shipping Wt: 24b (10.8kg)



ORDERING #

PROJECT:

TYPE:

DATE:

PREPARED BY:

COMMENTS:

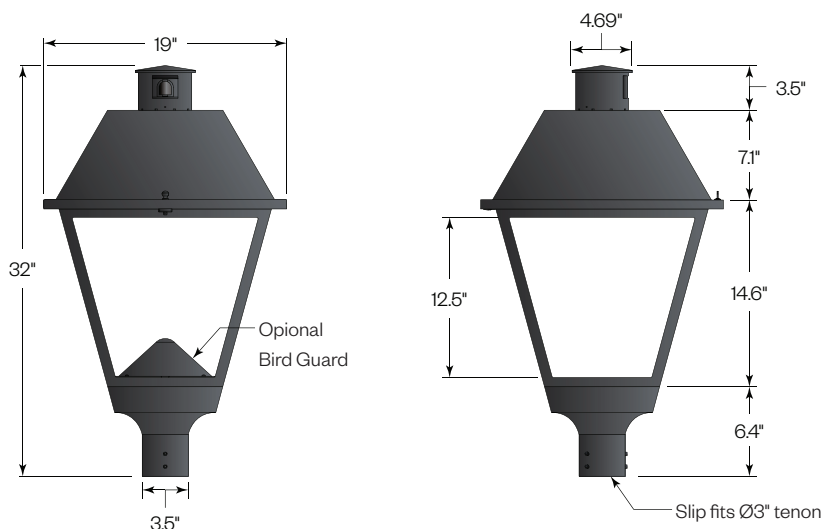

5 year limited warranty
AMERLUX LED
10 Year Warranty Available.
Consult Factory For Details.



COACH STYLE LANTERN

POST-TOP-MOUNT

CSL-P
LED

Ordering Information



1 Model
CSL-P

2 LED Modules
1M - 1 Module
2M - 2 Modules
3M - 3 Modules
4M - 4 Modules

3 CCT
30 - 3,000K
40 - 4,000K

4 Light Distribution
T2 - Type 2
T3 - Type 3
T4 - Type 4
T5 - Type 5

5 Voltage
120-277V (Standard)
347V/480V

6 Photocell Receptacle
3-pin (Standard)
7P - 7-pin

7 Finish
TBK - Textured Black
CLB - Classic Bronze
GBZ - Gloss Textured Bronze
GTB - Gloss Textured Black

8 Optional Lens
TA - Textured Acrylic

9 Accessory
BG - Bird Guard
BLS - Backlight Shield (Type II and Type III dist.)
TW-PCL - Twistlock Photocell

COACH STYLE LANTERN

POST-TOP-MOUNT

CSL-P
LED

Power

LED Modules	1M	2M	3M	4M
Power	24W	44W	60W	79W
Amperage Draw @ 120V (A)	.2	.36	.50	.65
Amperage Draw @ 277V (A)	.08	.15	.21	.28

Performance Chart

Driver Output	System Watts	Light Distribution	OCT	Lumens	BUG Rating	Lumens With TA Lens		
1M	24W	T2	3,000K	2,215	1-0-1	2,060		
			4,000K	2,395	1-0-1	2,227		
		T3	3,000K	2,234	1-0-1	2,078		
			4,000K	2,416	1-0-1	2,247		
		T4	3,000K	2,161	1-0-1	2,010		
			4,000K	2,336	1-0-1	2,228		
		T5	3,000K	2,257	1-0-0	2,099		
			4,000K	2,440	1-0-0	2,269		
		2M	44W	T2	3,000K	4,326	1-0-1	4,023
					4,000K	4,677	1-0-1	4,350
T3	3,000K			4,366	1-0-1	4,060		
	4,000K			4,720	1-0-1	4,390		
T4	3,000K			4,224	1-0-1	3,928		
	4,000K			4,567	1-0-2	4,247		
T5	3,000K			4,411	2-0-1	4,102		
	4,000K			4,769	2-0-1	4,435		
3M	60W			T2	3,000K	6,471	1-0-1	6,018
					4,000K	6,996	2-0-2	6,506
		T3	3,000K	6,524	2-0-2	6,067		
			4,000K	7,054	2-0-2	6,560		
		T4	3,000K	6,318	1-0-2	5,876		
			4,000K	6,831	1-0-2	6,353		
		T5	3,000K	6,598	3-0-1	6,136		
			4,000K	7,134	3-0-1	6,635		
		4M	79W	T2	3,000K	8,503	2-0-2	7,908
					4,000K	9,374	2-0-2	8,718
T3	3,000K			8,570	2-0-2	7,970		
	4,000K			9,193	2-0-2	8,549		
T4	3,000K			8,302	2-0-2	7,721		
	4,000K			8,976	2-0-2	8,616		
T5	3,000K			8,350	3-0-1	7,766		
	4,000K			8,976	3-0-1	8,348		

*Approximate lumens delivered from raw light engine.

Lumen Maintenance

Ambient Temp.	50,000 Hours*	70,000 Hours*	90,000 Hours*	100,000 Hours*	Theoretical L70 Hours
25°C	>95.4%	>93.9%	>92.4%	>91.6%	>200,000

* Per IESNA TM-21 data.

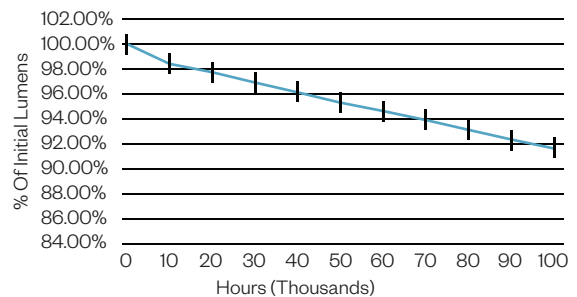

Lumen maintenance values apply to all output levels and distributions.

COACH STYLE LANTERN

POST-TOP-MOUNT

CSL-P
LED

Standard And Optional Lens Offering



An open cage with no lens is standard.



A textured acrylic lens is optional. Specify (TA) when ordering.

Installation Access

The CSL luminaire comes fully wired and ready for a simple installation. The terminal block is located below a tool-less access plate in the base of the luminaire.



Maintenance Access

Although not required for installation, all components are easily accessed below a hinged roof for maintenance if required.

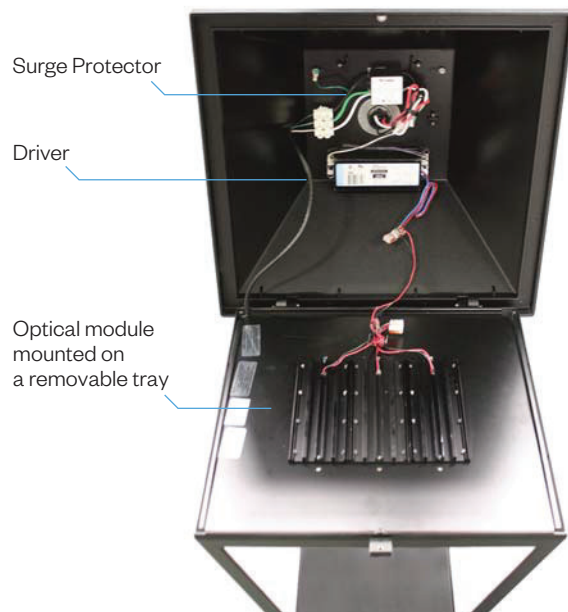

Performance Detail:

POLAR GRAPH: **CSL-P-4M-T2-4K**

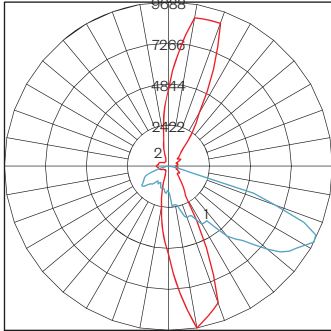

Maximum Candela = 9688 Located At Horizontal Angle = 280, Vertical Angle = 62.5
 #1 - Vertical Plane Through Horizontal Angles (280 - 100) (Through Max. Cd.)
 #2 - Horizontal Cone Through Vertical Angle (62.5) (Through Max. Cd.)

POLAR GRAPH: **CSL-P-4M-T3-4K**

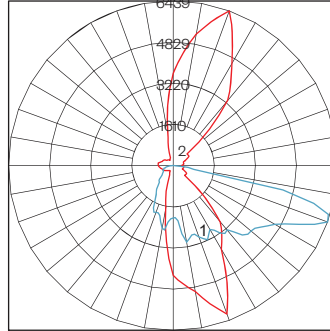

Maximum Candela = 6439 Located At Horizontal Angle = 70, Vertical Angle = 70
 #1 - Vertical Plane Through Horizontal Angles (70 - 250) (Through Max. Cd.)
 #2 - Horizontal Cone Through Vertical Angle (70) (Through Max. Cd.)

POLAR GRAPH: **CSL-P-4M-T4-4K**

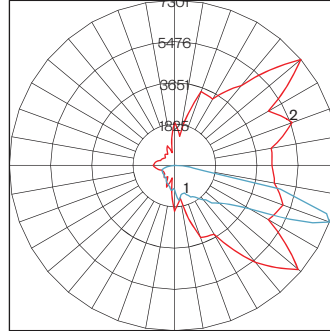

Maximum Candela = 7301 Located At Horizontal Angle = 40, Vertical Angle = 70
 #1 - Vertical Plane Through Horizontal Angles (40 - 220) (Through Max. Cd.)
 #2 - Horizontal Cone Through Vertical Angle (70) (Through Max. Cd.)

POLAR GRAPH: **CSL-P-4M-T5-4K**

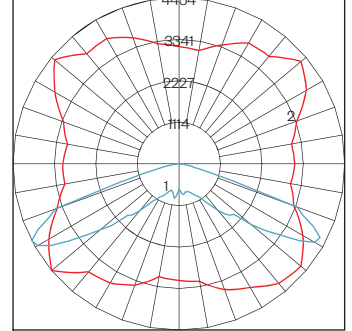

Maximum Candela = 4454 Located At Horizontal Angle = 220, Vertical Angle = 62.5
 #1 - Vertical Plane Through Horizontal Angles (220 - 40) (Through Max. Cd.)
 #2 - Horizontal Cone Through Vertical Angle (62.5) (Through Max. Cd.)

ISOFOOTCANDLE LINES OF HORIZONTAL ILLUMINANCE

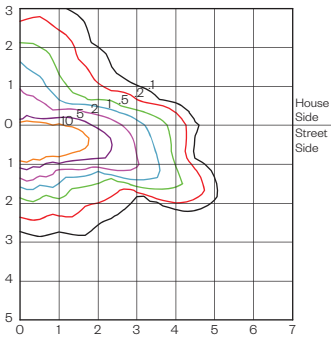

Distance In Units Of Mounting Height

ISOFOOTCANDLE LINES OF HORIZONTAL ILLUMINANCE

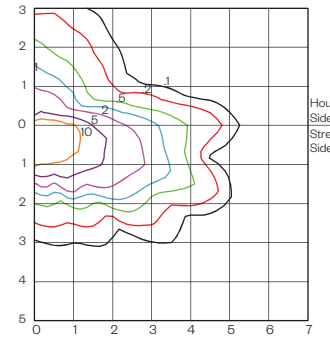

Distance In Units Of Mounting Height

ISOFOOTCANDLE LINES OF HORIZONTAL ILLUMINANCE

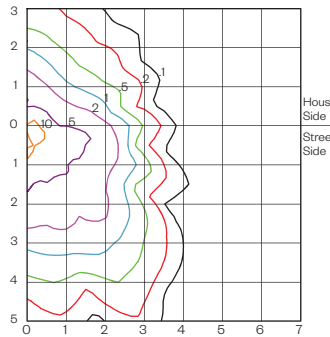

Distance In Units Of Mounting Height

ISOFOOTCANDLE LINES OF HORIZONTAL ILLUMINANCE

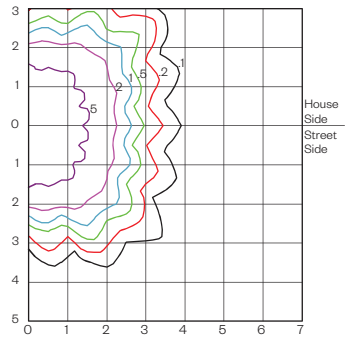

Distance In Units Of Mounting Height

Customizable Performance

Photometry can be modified using different drive currents and a combination of lenses. Consult factory. See examples below.

CLS-P-4M-4K-T3ST2H-580M

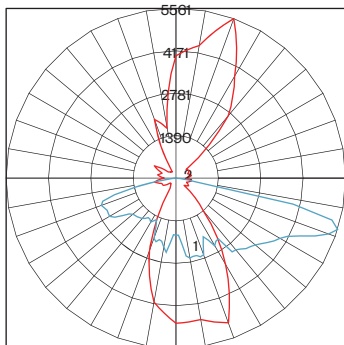

Maximum Candela = 5561 Located At Horizontal Angle = 70, Vertical Angle = 72.5
 #1 - Vertical Plane Through Horizontal Angles (70 - 250) (Through Max. Cd.)
 #2 - Horizontal Cone Through Vertical Angle (72.5) (Through Max. Cd.)

CSL-P-3M-T3ST2H-4K-470M

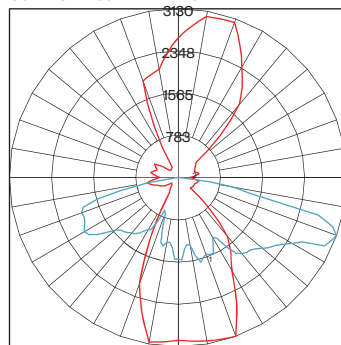

Maximum Candela = 3130 Located At Horizontal Angle = 290, Vertical Angle = 70
 #1 - Vertical Plane Through Horizontal Angles (290 - 110) (Through Max. Cd.)
 #2 - Horizontal Cone Through Vertical Angle (70) (Through Max. Cd.)

Backlight Shield

Shield can be easily installed in the field when required.

