

D142 SERIES LUMINAIRE

U.11.14.18

DESCRIPTION

The contemporary styled D142 Series combines a cast aluminum housing, a spun aluminum shade and a choice of optical systems to create an efficient luminaire with several light distributions.

HID ELECTRICAL

- High power factor ballast (HPF), core and coil type, pre-wired and tested
- 4KV porcelain socket

ETL listed, suitable for wet locations.

INSTALLATION

The luminaire and crook will mount to a 4" OD post or tenon with 5/16" black oxide coated stainless steel set screws to ensure a solid connection.

OPTICAL SYSTEMS

HR3 -Type III segmented reflector with a clear glass lens.

HR5 -Type V segmented reflector with a clear glass lens.

FINISH:

Durable thermoset polyester powdercoat finish in the following:

- Satin Black (**BLK**)
- Classic Bronze (**CLB**)
- Gloss Textured Bronze (**GBZ**)
- Green (**GRN**)
- Gloss Textured Black (**GTB**)
- Textured Black (**TBK**)
- Gloss Textured Green (**TGR**)

D142 SERIES
HID



PROJECT:

LOCATION:

FIXTURE TYPE:

NOTES:



With PA lens



With HR-GL

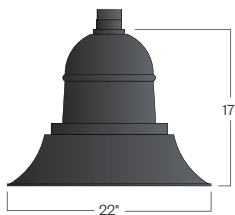

D142-FS22
EPA: 114

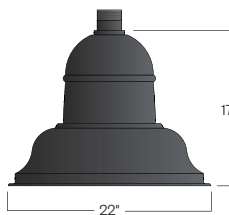

D142-RFS22
EPA: 1.2

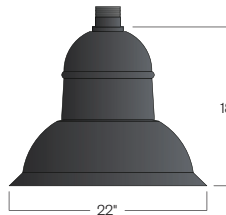

D142-SDS22
EPA: 1.26

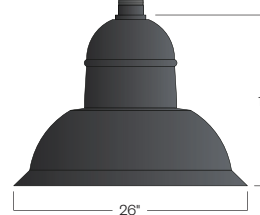

D142-SDS26
EPA: 1.52



D142 SERIES LUMINAIRE

D142 SERIES
HID

Ordering Information



1 Model
D142-FS22
D142-RFS22
D142-SDS22

4 Voltage
120V
208V
240V
277V

2 Optical System
HR3 - Type 3 Reflector
HR5 - Type 5 Reflector

5 Finish
BLK - Satin Black
CLB - Classic Bronze
GBZ - Gloss Textured Bronze
GRN - Green
GTB - Gloss Textured Black
TBK - Textured Black
TGR - Gloss Textured Green
CSTM - Custom

3 Light Source
70MH - 70w Metal Halide
100MH - 100w Metal Halide
150MH - 150w Metal Halide
70HPS - 70w High Pressure Sodium
100HPS - 100w High Pressure Sodium
150HPS - 150w High Pressure Sodium
MDO - Medium Socket Only
MGO - Mogul Socket Only

Mounting Ordering Information

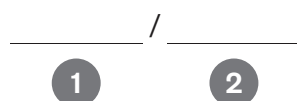

1 Model
CBR01-1-24
CBR01-1-36
CBR40-1-24-L
CBR40-2-24-L
CBR81-1-30
CBR81-2-30
PT40
PT41R
PT42R

2 Finish
BLK - Satin Black
CLB - Classic Bronze
GBZ - Gloss Textured Bronze
GRN - Green
GTB - Gloss Textured Black
TBK - Textured Black
TGR - Gloss Textured Green
CSTM - Custom

Assembly Details
(Example: PT40/D142-RFS22/HR5-GL)



Standard Photometry

D142-RFS22/HR5
Typical HID light source
14,000 Lumen
12' Mounting Height
Grid Spacing is 12'

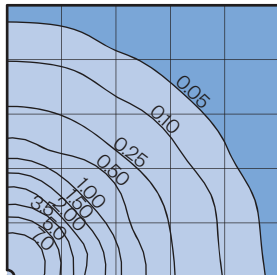

Socket Types

Wattage	Socket Size
70MH;100MH;150MH	Medium
70HPS;100HPS	Medium
150HPS	Mogul

Mounting Options

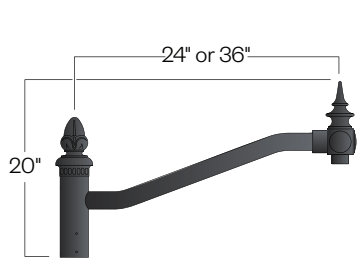

CBR01-1-36 or CBR01-1-24

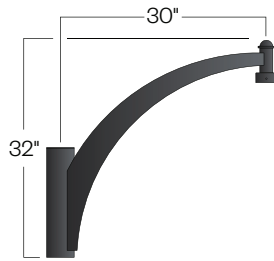

CBR81-1-30

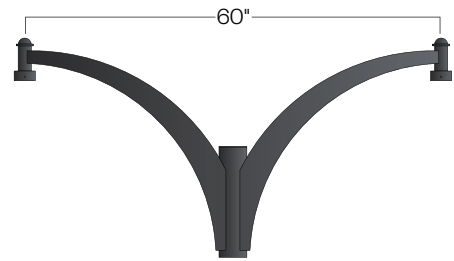

CBR81-2-30

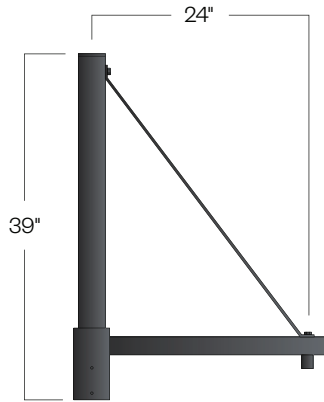

CBR40-1-24-L

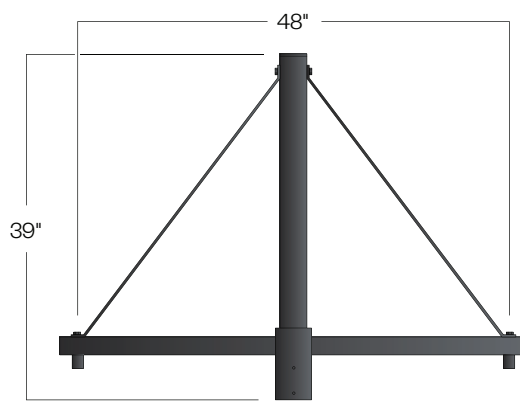

CBR40-2-24-L

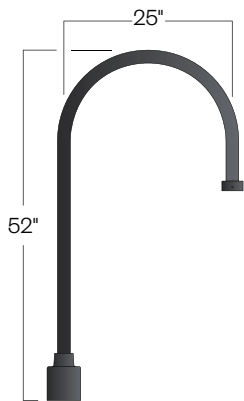

PT40

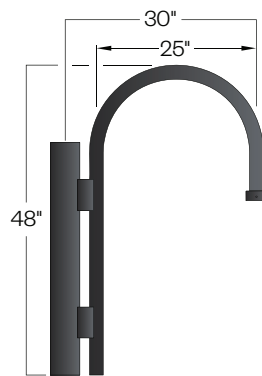

PT41R

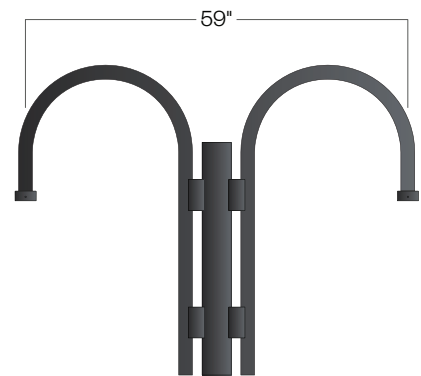

PT42R