

# GLOBAL TRACK SINGLE CIRCUIT 120V

**GES**  
1 CIR 120V

**APPLICATIONS:**

Power supply for Amerlux® track lighting fixtures

**CONSTRUCTION:**

Architectural grade, extruded aluminum housing  
Milled grounding bar provides continuous ground contact  
Continuously crimped conductor ensures mechanical strength and electrical reliability  
Black, white or natural aluminum

**MOUNTING:**

T-Grid, aircraft cable or stem mount options  
Stem mounting is field cuttable  
Max. 4' O.C. suspension points

**LABELING:**



PROJECT:  
  
TYPE:

**GES Track Components**

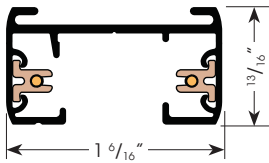

**Dead End**  
GES41



**T-Bar Feed Kit**  
GES17

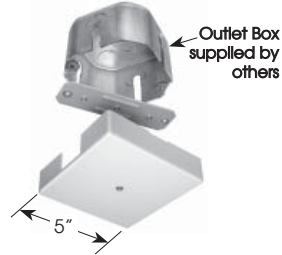

**J-Box Kit**  
675-0094K

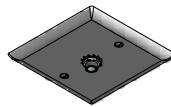

(for Nordic track adapter)

**Monopoint**  
GES70

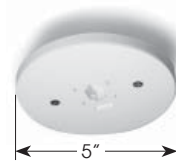

**Track Reinforcement Plate**  
GEA21



Accessories not shown:  
GES67 - floating canopy feed  
677-0801 - T-bar ceiling clip

**ELECTRICAL**

Single circuit, 120v track  
20 amp max.

**ORDERING INFORMATION:**

TRACK Model	Finish	COMPONENTS (ordered separately) Model	Finish
GES204 (44")	1 - gray	GES11 - live end	1 - gray
GES208 (92")	2 - black	GES12 - live end, reverse	2 - black
GES212 (140")	3 - white	GES13 - conduit end	3 - white
		GES14 - center feed	
		GES17 - T-bar feed kit	
		GES21 - straight connector	
		GES34 - L connector, adjustable universal polarity	
		GES38 - X connector	
		GES40 - T connector, adjustable universal polarity	
		GES41 - dead end	
		GES67 - floating canopy feed	
		GES70 - monopoint	
		677-0801 - T-bar ceiling clip	
		644-5146 - Flex connector	
		GEA21 - track reinforcement plate	
		675-0094K - J-Box Kit, specify color (WT, BT, ST)	

Track Example: GES204-2  
Component Example: GES11-2

Cat #:

Amerlux reserves the right to change details that do not affect overall function and performance.



# GLOBAL TRACK SINGLE CIRCUIT 120V

GES  
1 CIR 120V



TYPE:



## GES Track Configuration and Components

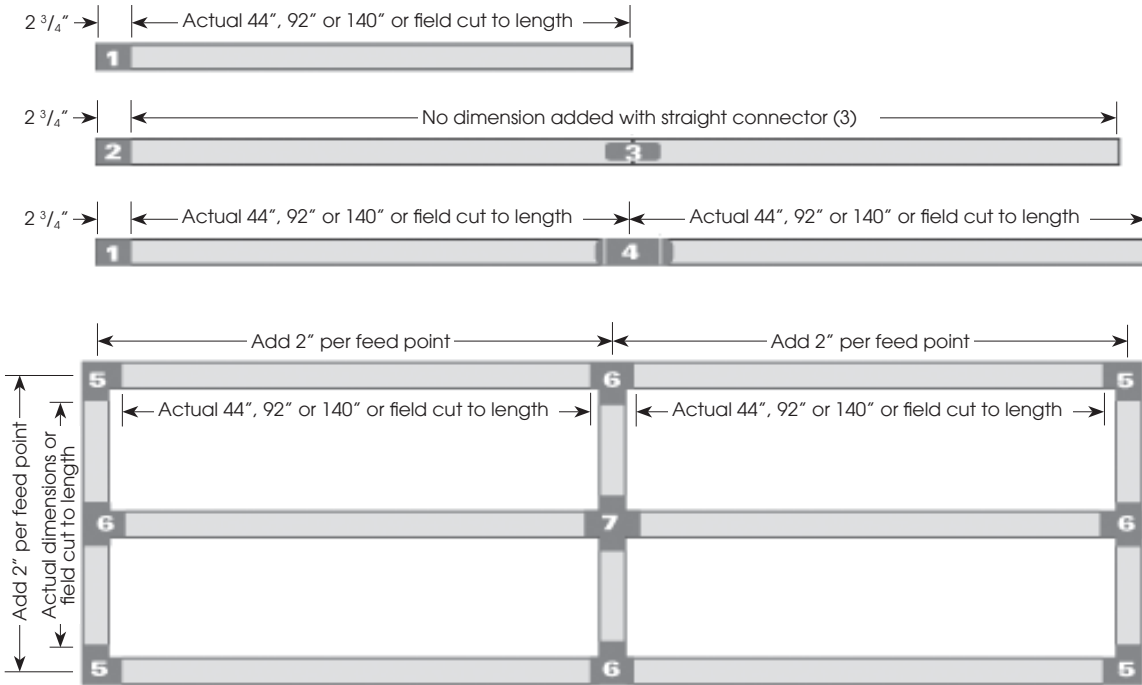

1. Live End Feed  
GES11



2. Conduit End Feed  
GES13



3. Straight Connector  
GES21



Flex Connector  
644-5146



4. Center Feed  
GES14



5. L Connector  
GES34



6. T Connector  
GES40



7. X Connector  
GES38



### T-GRID SUSPENSION

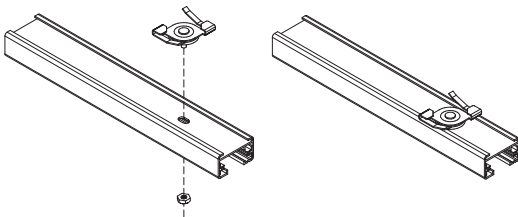

### STEM MOUNT SUSPENSION

Stem mounts are field cuttable

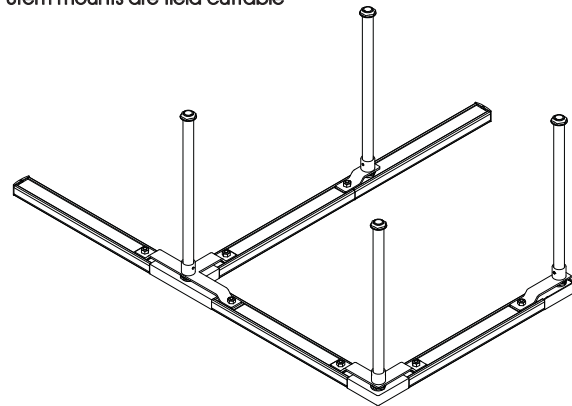

### AIRCRAFT CABLE SUSPENSION

