

# GLOBAL TRACK

2 CIRCUIT/2 NEUTRAL 277V

HTEK  
2CIR 277V

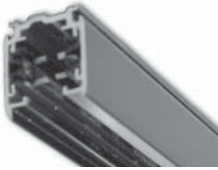

**APPLICATIONS:**

Power supply for Amerlux track lighting fixtures

**MOUNTING:**

T-grid, threaded rod or aircraft cable suspension

**CONSTRUCTION:**

Architectural grade, extruded aluminum housing  
Milled grounding bar provides continuous ground contact  
Continuously crimped conductor ensures mechanical strength and electrical reliability  
Black, white or gray powder coat finish

**LABELING:**



PROJECT:  
  
TYPE:

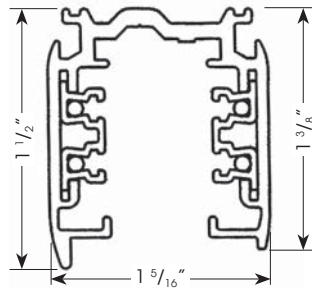

**ELECTRICAL**

2 circuit/2 neutral, 277v track  
20 amps per circuit (originating from the same phase)

**ORDERING INFORMATION:**

TRACK Model	Finish	COMPONENTS (ordered separately) Model	Finish
HTEK44 4' (48")	1 - gray	HTEK11 - live end, left	1 - gray
HTEK48 8' (96")	2 - black	HTEK12 - live end, right	2 - black
HTEK412 12' (144")	3 - white	HTEK14 - live center feed	3 - white
		TEK21 - straight connector	
		HTEK24 - adjustable connector	
		HTEK34 - L connector, adjustable universal polarity	
		HTEK38 - X connector	
		HTEK39 - T connector, adjustable right polarity	
		HTEK40 - T connector, adjustable left polarity	
		TEK41 - dead end	
		HW-0171K - T-bar clip	
		HW-0068 - cable gripper	
		CA-0005 - aircraft cable, 20ft	
		CO-0094K - J-box cover	
		SKB12-1 - ceiling clamp (for cable and rod mounting, aluminum finish only)	
		XTSV12 - bending tool	

Example: HTEK48-2

Cat #:

Amerlux® reserves the right to change details that do not affect overall function and performance.



# GLOBAL TRACK

2 CIRCUIT/2 NEUTRAL 277V



TYPE:

HTEK  
2CIR 277V

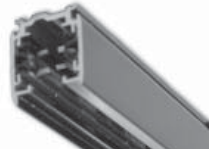

## HTEK TRACK CONFIGURATION & COMPONENTS:

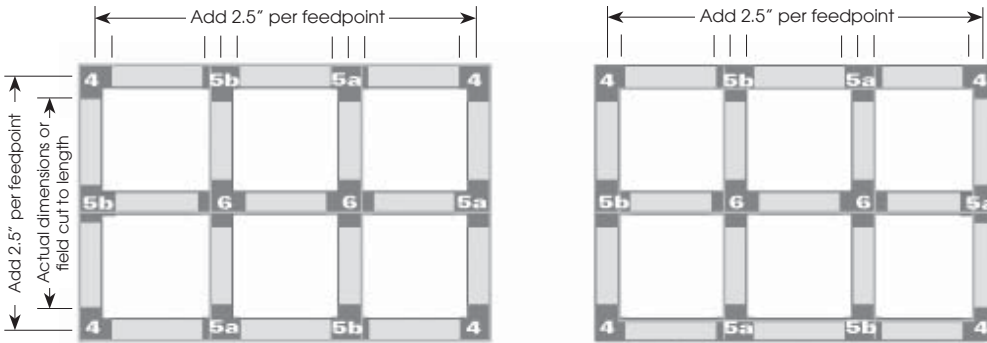
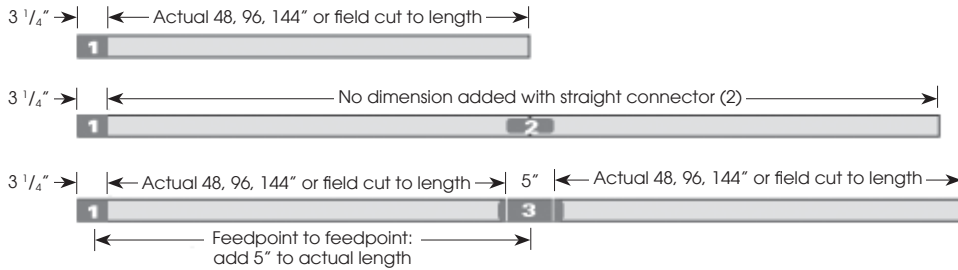

HTEK is polarized and manufactured with identifying ridges (the larger shown as a bold line on diagrams). Refer to these diagrams to ensure proper connector selection.

### Additional Accessories (not pictured):

- SKB12-1 Ceiling clamp
- HW-0171K T-bar Clip
- HW-0068 Cable Gripper
- CA-0005 A/C cable, 20ft
- CO-0094K J-box Cover
- XTSV12 bending tool



TEK41 Dead End



HTEK24 Adjustable Connector

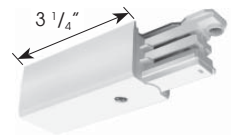

HTEK11 Live End (left) - standard  
HTEK12 Live End (right)  
(used for conduit feed also)



TEK21 Straight Connector

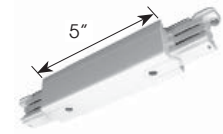

HTEK14 Live Center Feed

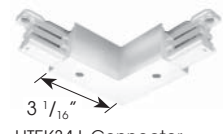

HTEK34 L Connector  
(adjustable universal polarity)

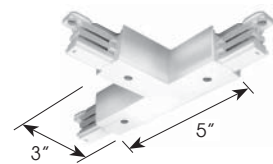

HTEK39 T Connector  
(adjustable right polarity)  
HTEK40 T Connector  
(adjustable left polarity)

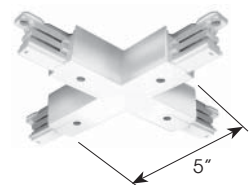

HTEK38 X Connector

## SUSPENSION OPTIONS:

### T-GRID SUSPENSION

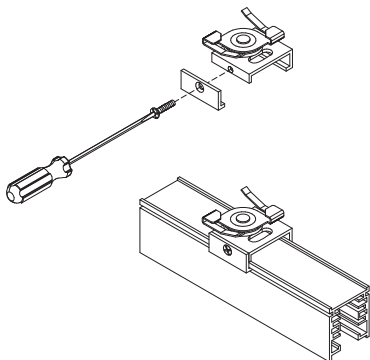

### AIRCRAFT CABLE SUSPENSION

