

GLOBAL TRACK

2 CIRCUIT/2 NEUTRAL 277V

HTEK
2CIR 277V

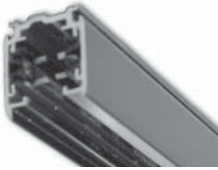

APPLICATIONS:

Power supply for Amerlux track lighting fixtures

MOUNTING:

T-grid, threaded rod or aircraft cable suspension

CONSTRUCTION:

Architectural grade, extruded aluminum housing
Milled grounding bar provides continuous ground contact
Continuously crimped conductor ensures mechanical strength and electrical reliability
Black, white or gray powder coat finish

LABELING:



PROJECT:

TYPE:

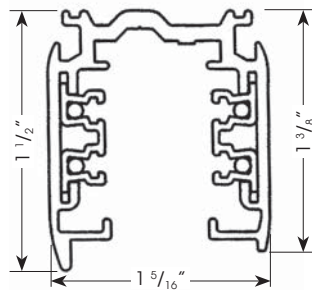

ELECTRICAL

2 circuit/2 neutral, 277v track
20 amps per circuit (originating from the same phase)

ORDERING INFORMATION:

| TRACK Model | Finish | COMPONENTS (ordered separately) Model | Finish |
|--------------------|-----------|----------------------------------------------------------------------------|-----------|
| HTEK44 4' (48") | 1 - gray | HTEK11 - live end, left | 1 - gray |
| HTEK48 8' (96") | 2 - black | HTEK12 - live end, right | 2 - black |
| HTEK412 12' (144") | 3 - white | HTEK14 - live center feed | 3 - white |
| | | TEK21 - straight connector | |
| | | HTEK24 - adjustable connector | |
| | | HTEK34 - L connector, adjustable universal polarity | |
| | | HTEK38 - X connector | |
| | | HTEK39 - T connector, adjustable right polarity | |
| | | HTEK40 - T connector, adjustable left polarity | |
| | | TEK41 - dead end | |
| | | 636-0171K - T-bar clip assembly kit | |
| | | 636-0068 - cable gripper | |
| | | 614-0005 - aircraft cable, 20ft | |
| | | 675-0094K - J-box cover | |
| | | SKB12-1 - ceiling clamp (for cable and rod mounting, aluminum finish only) | |
| | | XTSV12 - bending tool | |

Example: HTEK48-2

Cat #:

Amerlux® reserves the right to change details that do not affect overall function and performance.



GLOBAL TRACK

2 CIRCUIT/2 NEUTRAL 277V



TYPE:

HTEK
2CIR 277V

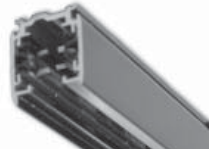

HTEK TRACK CONFIGURATION & COMPONENTS:

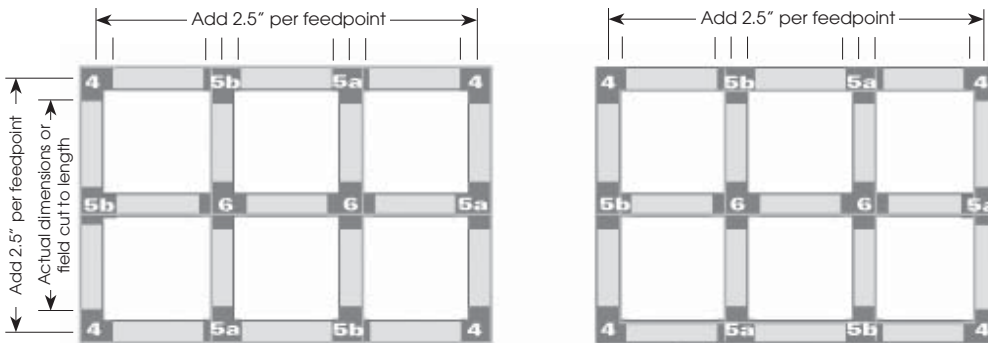
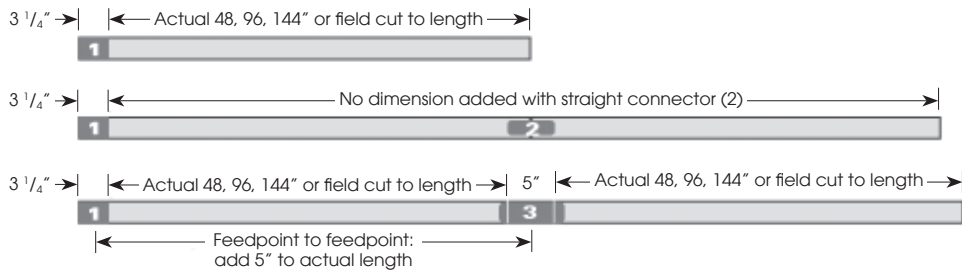

HTEK is polarized and manufactured with identifying ridges (the larger shown as a bold line on diagrams). Refer to these diagrams to ensure proper connector selection.

Additional Accessories (not pictured):

- SKB12-1 Ceiling clamp
- 636-0171K T-bar Clip Assembly Kit
- 636-0068 Cable Gripper
- 614-0005 A/C cable, 20ft
- 675-0094K J-box Cover
- XTSV12 bending tool



TEK41 Dead End



HTEK24 Adjustable Connector

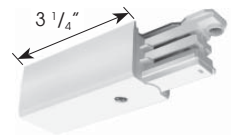

HTEK11 Live End (left) - standard
HTEK12 Live End (right)
(used for conduit feed also)



TEK21 Straight Connector

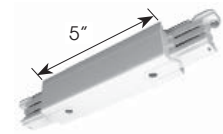

HTEK14 Live Center Feed

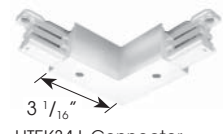

HTEK34 L Connector
(adjustable universal polarity)

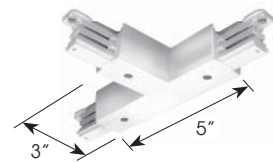

HTEK39 T Connector
(adjustable right polarity)
HTEK40 T Connector
(adjustable left polarity)

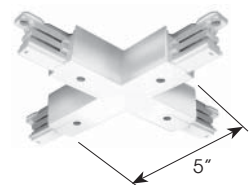

HTEK38 X Connector

SUSPENSION OPTIONS:

T-GRID SUSPENSION

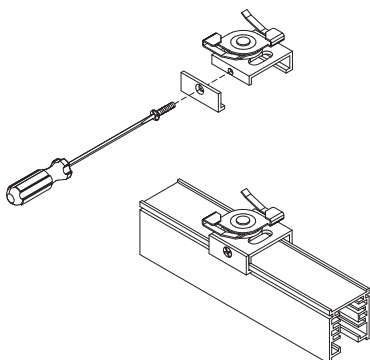

AIRCRAFT CABLE SUSPENSION

