

GLOBAL TRACK 3 CIRCUIT 120V

XTS
3 CIR 120V

APPLICATION:

Power supply for Amerlux track lighting fixtures

LABELING:

cUL listed

CONSTRUCTION:

Architectural grade, extruded aluminum housing
Milled grounding bar provides continuous ground contact
Continuously crimped conductor ensures mechanical strength and electrical reliability
Black, white or natural aluminum

MOUNTING:

T-Grid, threaded rod or aircraft cable suspension
Max. 6' O.C. suspension points



PROJECT :

TYPE :

ELECTRICAL

3 circuit, 120v track
20 amps per circuit

Amerlux reserves the right to change details that do not affect overall function and performance.

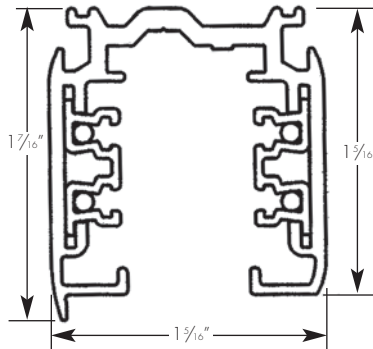

ORDERING INFORMATION:

TRACK Model	Finish	COMPONENTS* Model	Finish
XTS44 4' (48")	1 - gray	XTS11 - live end, left	1 - gray
XTS48 8' (96")	2 - black	XTS12 - live end, right	2 - black
XTS412 12' (144")	3 - white	XTS14 - live center feed	3 - white
		XTS21 - straight connector	
		XTS23 - flexible connector	
		XTS34 - L connector, adjustable universal polarity	
		XTS38 - X connector	
		XTS39 - T connector, adjustable right polarity	
		XTS40 - T connector, adjustable left polarity	
		TEK41 - dead end	
		636-0171K - T-bar clip	
		636-0068 - cable gripper	
		614-0005 - aircraft cable 20'	
		CO-0094K - J-box cover	
		SKB12-1 - ceiling clamp (for cable and rod mounting, aluminum finish only)	
		XTSV12 - bending tool**	
		MONO - monopoint kit (-B - black, -W - white)	

*Components ordered separately
**Bending tool bends conductors to proper angle when track is field cut

Track Example: XTS44-2
Component Example: XTS11-2

Cat #:

GLOBAL TRACK 3 CIRCUIT 120V

XTS
3 CIR 120V



TYPE :

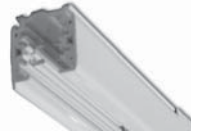

XTS TRACK COMPONENTS

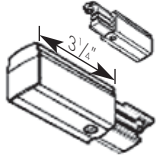

XTS 11 Live End (left) -standard
XTS 12 Live End (right)
(Used for Conduit feed also)

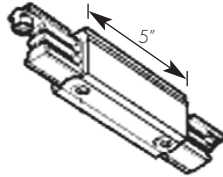

XTS 14 Live Center Feed



XTS 21 Straight Connector

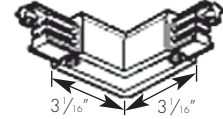

XTS 34 L Connector
(adjustable universal polarity)

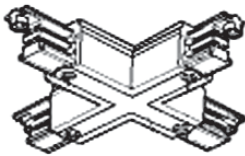

XTS 38 X Connector

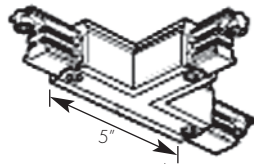

XTS 39 T Connector (adjustable right polarity)
XTS 40 T Connector (adjustable left polarity)

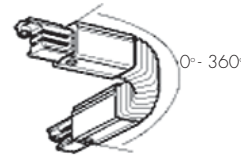

XTS 23 Flex Connector

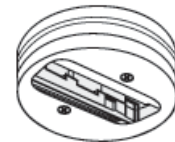

Monopoint Kit:
Mono-B (black)
Mono-W (white)



XTS 41 Dead End

ADDITIONAL ACCESSORIES NOT PICTURED:

- 675-0094K - Cover Plate for J box
- SKB12-1 - Ceiling Clamp
- 636-0171K - T-Bar Clip
- XTSV12 - Bending Tool
- 636-0068 - Cable Gripper
- 614-0005 - A/C Cable 20'

SUSPENSION OPTIONS

T-GRID SUSPENSION

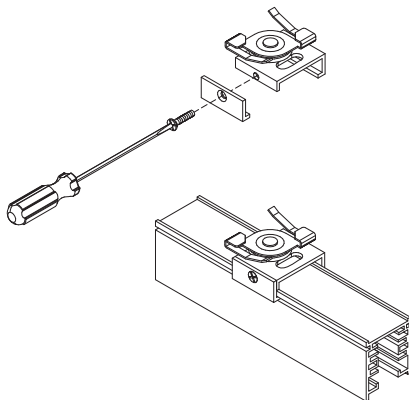

AIRCRAFT CABLE SUSPENSION

