

DRAMA-LINEAR WALL GRAZER

LED

APPLICATIONS:

Wall grazing for commercial, retail and hospitality spaces

CONSTRUCTION:

Extruded aluminum housing
Die-formed aluminum, galvanized and cold rolled steel internal components
Die-formed aluminum module bracket painted black
Stamped steel end cap painted black
Housing lengths are 4' or 8' nominal for individual fixtures

MOUNTING:

Sheet rock ceilings
Fixtures may be continuously row-mounted
Straight runs only
Corners are not available

OPTICS:

Extruded aluminum optic-custom polished finish
4 LED linear array modules per nominal 4' section,
2700°K, 3000K, 3500K, 85 CRI

ELECTRICAL:

Electronic constant voltage 24v DC LED driver, 120v/277v
Optional 0-10v dimming equipment and relay module by others, consult factory
This product complies with IEEE C62.41 for surge endurance up to 2.5kV. Amerlux recommends using additional surge protection with this unit (supplied by others), surge damage is not covered by warranty.

LABELING:



Chicago Plenum
For indoor use only

DRA-LWG
LED

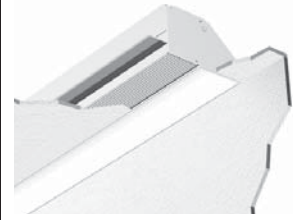

PROJECT:

TYPE:

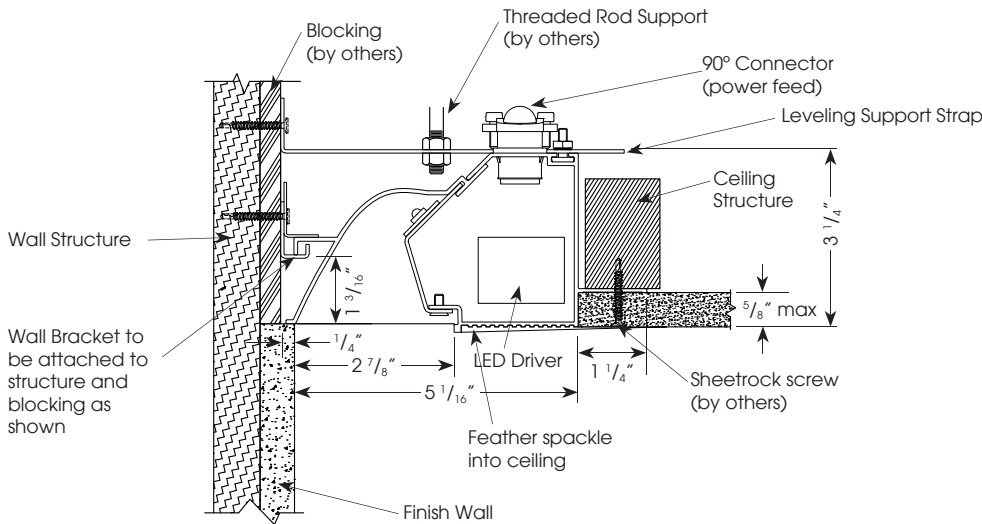

ELECTRICAL

Driver	Wattage per foot	Lamping				
		4'		8'		
		Input watts	Amps	Input watts	Amps	
Electronic	8	120v	.37	.31	.74	.62
		277v	.37	.13	.74	.26

ORDERING INFORMATION:

Model	Wattage per Foot	Lamp Type	Finish	Length	Configuration	Voltage	Color Temp	Options/Accessories
DRA-LWG	8	LED	PAL - polished aluminum DAL - diffuse aluminum	4 - 4' individual 8 - 8' individual ___ run length in increments of 1' (consult factory)	IND - individual BOR - beginning of run EOR - end of run MOR - middle of run	120/277	2700 3000 3500 Consult factory for other color temperature options	0-10V - 0-10V dimming CP - Chicago Plenum

Example: DRA-LWG-8-LED-PAL-4-IND-120/277-2700

Cat #:

Amerlux reserves the right to change details that do not affect overall function and performance.



DRAMA-LINEAR WALL GRAZER

LED

DRA-LWG
LED



TYPE:

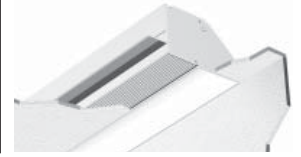

RUN LENGTHS:

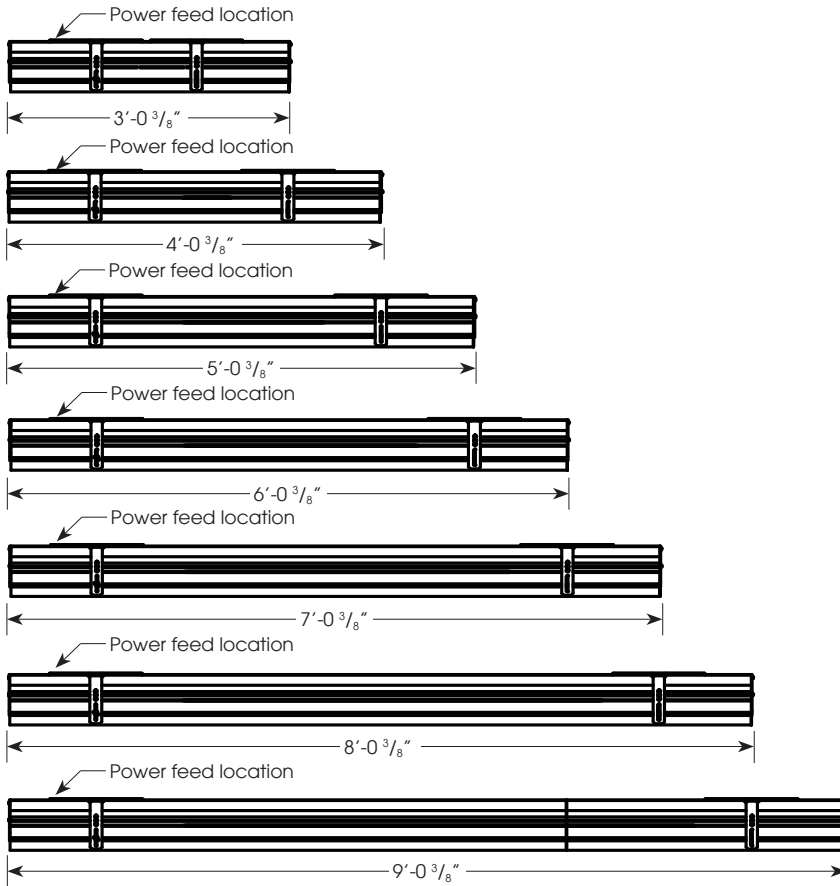

CONTINUOUS RUN LENGTH EXAMPLE:

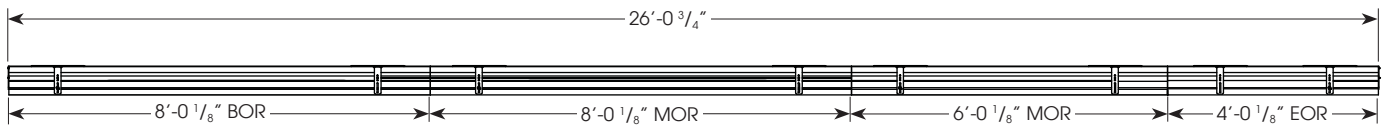

For Continuous Rows specify BOR, MOR, & EOR quantities:

Fixture Type	BOR		MOR		EOR		NOMINAL ROW LENGTH, FT	ACTUAL ROW LENGTH, IN
	4	8	4	8	4	8		

DRAMA-LINEAR WALL GRAZER

LED

DRA-LWG
LED



TYPE:



FIXTURE DATA:

Complete photometric data (.ies format) available upon request.

DRA-LWG 8W LED DAL 4' IND 3000K
SOURCE: 96 white LEDs LUMENS: 827.1
RECESSED

LTL# 24071

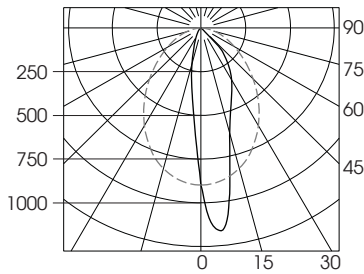

ZONAL LUMEN SUMMARY

Zone	Lumens	%Lamp	%Fixt
0-30	425.8	N/A	51.5
0-40	590.4	N/A	71.4
0-60	777.9	N/A	94.1
0-90	827.1	N/A	100.0
90-180	0	N/A	0.0
0-180	827.1	N/A	100.0

Total Luminaire Efficiency = 19.1 Lumens/Watt

COEFFICIENTS OF UTILIZATION

Effective Floor Cavity Reflectance 20%

RC	80			
	70	50	30	10
RW				
RCR				
0	985	985	985	985
1	927	899	874	851
2	868	818	777	742
3	812	747	696	656
4	760	684	629	587
5	713	630	572	530
6	671	583	524	482
7	632	542	483	442
8	597	505	448	408
9	565	473	417	379
10	536	444	390	353

Note: Values are expressed as Lumens delivered to the task surface

DRA-LWG 8W LED PAL 4' IND 3500K
SOURCE: 96 white LEDs LUMENS: 1219
RECESSED

LTL# 35974

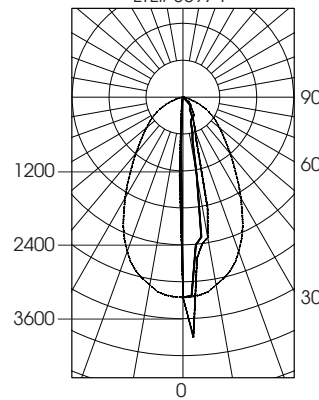

ZONAL LUMEN SUMMARY

Zone	Lumens	%Lamp	%Fixt
0-30	700	N/A	57.45
0-40	905	N/A	74.25
0-60	1154	N/A	94.64
0-90	1219	N/A	100.0
90-180	0	N/A	0.0
0-180	1219	N/A	100.0

Total Luminaire Efficiency = 28.3 Lumens/Watt

COEFFICIENTS OF UTILIZATION

Effective Floor Cavity Reflectance 20%

RC	80			
	70	50	30	10
RW				
RCR				
0	1451	1451	1451	1451
1	1378	1341	1317	1280
2	1304	1256	1195	1158
3	1243	1158	1097	1048
4	1182	1085	1024	963
5	1122	1012	939	890
6	1061	951	878	829
7	1000	890	817	768
8	963	841	768	719
9	902	792	719	671
10	866	744	671	622

Note: Values are expressed as Lumens delivered to the task surface