

# CONTOUR VERTICAL 4X4

## TRACK LED

CNTRV44  
LED

### APPLICATION:

Retail & commercial accent & display lighting

### CONSTRUCTION:

Extruded aluminum ballast housing and heatsink  
Stamped aluminum end plates  
Formed steel wire cover  
Powder coat paint, available in over 200 finishes

### ELECTRICAL:

Electronic constant current LED driver  
120v or 277v input  
Dimming down to less than 20%, available on 120v only with ELV (reverse phase) dimming equipment, consult factory for approved device list

**This product complies with IEEE C62.41 for surge endurance up to 2.5KV. Amerlux® recommends using additional surge protection with this unit (supplied by others), surge damage is not covered by warranty.**

### OPTICS:

LED cluster  
Color Temp: 2700K, 3000K, 3500K, 4000K  
CRI: 85  
Binning: 3 MacAdam (SDMC)  
Life: 50,000 hrs  
Lumen Maintenance: >70% of initial lumens @ 50,000 hrs  
Lumen Output (@ 2700K): 2221 typ Narrow Flood, 1821 typ Medium Flood, 2052 typ Flood, 1825 typ Wide Flood  
0-90° tilt, 360° rotation  
Beam Options: Narrow Flood 16°, Medium Flood 24°, Flood 30°, Wide Flood 45°, Very Wide Flood 60°

### MOUNTING:

Track, canopy and busway  
**Note: Ceiling mounted track only**

### LABELING:

 Approved to UL standards as tested by CSA  
For indoor use only

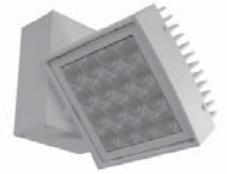

PROJECT:

TYPE:

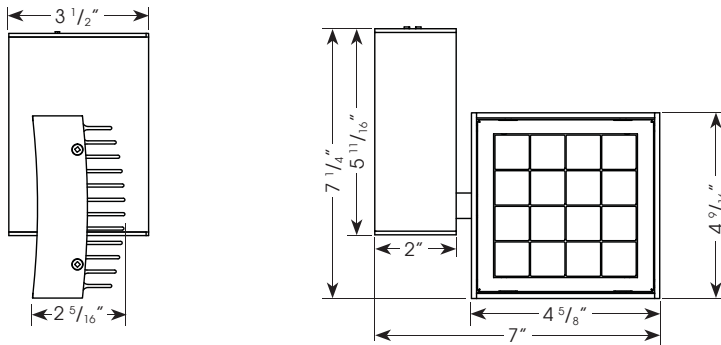

### ELECTRICAL

Driver	System Watts	Amps
Electronic 120v	32	.27
277v	32	.12

Class 2 constant current driver, 600 mA

  
Electrostatic sensitive device,  
observe precautions for  
handling

  
(see next page for details)



(see page 4)



(see website for details)

### ORDERING INFORMATION:

Model	Wattage	Lamp Type	Ballast	Finish	Mounting	Voltage	Beam Spread	Color Temp	Options
CNTRV44	32	LED	E - electronic	WT - white texture BT - black texture ST - silver texture — (other RAL)	TN1 - Global GES 1cir/H-Style, 120v TEK - Global TEK 2cir/2neut, 120v TN3 - Global XTS 3cir, 120v TN2 - Global HTEK 2cir/2neut, 277v CT - J-Style LOL - L-Style LLAB - Litelab Bus Run, 120v B - busway C - canopy CCL2 - C-clamp with SCP - straight cord, 6' CCP - coil cord, 5'	120 277	NF - narrow flood, 16° MFL - medium flood, 24° FL - flood, 30° WF - wide flood, 45° VWF - very wide flood, 60° SL - linear spread lens, 12° x 48°	2700 3000 3500 4000	DIM-ELV - ELV dimming (120v only) <b>Snoot</b> (accepts up to 2 forms of light control media) SN - snoot 1", specify WT, BT, ST finish <b>Light Control Media</b> (requires snoot) CB - cross blade 1/2" deep, 16 cell, black (B) finish standard HEX - hexcell louver, 1/8" x 1/8" SPR - prismatic spread lens (use only with NF, FL) LSPR - linear spread lens (do not use if SL beam spread is specified)

Example: CNTRV44-32-LED-E-WT-TN1-120-NF-3000

Cat #:

Amerlux reserves the right to change details that do not affect overall function and performance.



# QUICKSHIP CONTOUR VERTICAL 4X4

TRACK LED

CNTRV44  
LED

Amerlux® QuickShip makes it possible not only to keep up with expectations, but to keep ahead of them. We help enhance your competitive edge, ensuring you can start installation more quickly than you thought possible.

We can ship within 5-10 business days of your Amerlux QuickShip order, depending upon the selection.

- **QuickShip must be clearly marked on all P.O.'s.**
- **Must note on P.O. if requesting frames ship first.**
- **Standard shipping terms apply.**
- **See terms & conditions below.**

**Quantity:** 250 pieces or less  
5 days

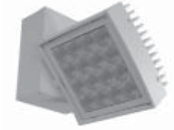

PROJECT:

TYPE:

### QUICKSHIP ORDERING INFORMATION:

Model	Wattage	Lamp Type	Ballast	Finish	Mounting	Voltage	Beam Spread	Color Temp	Options/ Accessories
CNTRV44	32	LED	E - electronic	WT - white texture BT - black texture	TN1 - Global GES 1 cir/ H-style, 120v CT - J-style LOL - L-style	120 277	NF - narrow flood, 16° MFL - medium flood, 24° FL - flood, 30° WF - wide flood, 45° VWF - very wide flood, 60°	83 CRI 3000 3500	DIM-ELV - ELV dimming (120v only)

Complete **QuickShip** Example: CNTRV44-32-LED-E-WT-TN1-1 20-NF-3000-DIM-ELV

Cat #:

## Terms & Conditions

1. For QuickShip processing, please submit QuickShip items on separate purchase order and indicate "QuickShip" on order.
2. Configurations outside of what is displayed on the QuickShip program are not available under the QuickShip lead times.
3. Please contact Customer Support to process orders with quantities larger than those listed.
4. Orders will be entered within 24 hours of receipt of a clean purchase order. Lead times are calculated by business days from time of sales order confirmation. Orders will ship within QuickShip lead times or sooner.
5. Change orders and order cancellations cannot be processed after sales order confirmation is generated.
6. For freight allowed (greater than \$3,000), order will ship complete based on longest lead time item. Please indicate on PO if Partial Shipments are approved and indicate freight method. For partial shipments under \$3,000, customer will be invoiced for freight.
7. All Lead times indicate when the fixture ships from Amerlux®. Arrival at destination is contingent upon carrier.

**Expedite your orders by providing:**

- **Separate purchase order noting "QuickShip Program"**
- **Complete and accurate configurations**
- **Accurate pricing, quote number, shipping and contact information**

**Amerlux reserves the right to modify this program at any time.**

# CONTOUR VERTICAL 4X4

TRACK LED

CNTRV44  
LED



TYPE:

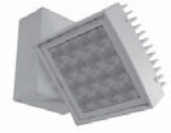

**FIXTURE DATA:**

Complete photometric data (ies format) available upon request.

**32W LED 2700K**

NARROW FLOOD 16°  
DISTRIBUTION  
LTL # 227548

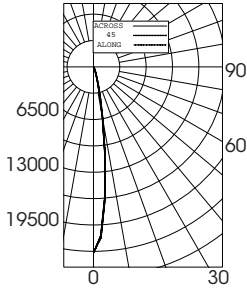

Candelas at Nadir	
Deg	Candela
0	22906
5	16340
15	2244
25	410
35	77
45	35

MEDIUM FLOOD 24°  
DISTRIBUTION  
LTL # 227550

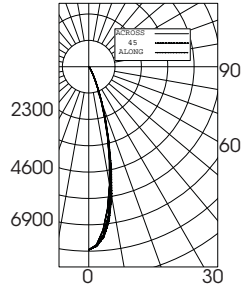

Candelas at Nadir	
Deg	Candela
0	8130
5	7411
15	3413
25	831
35	192
45	65

FLOOD 30°  
DISTRIBUTION  
LTL # 227549

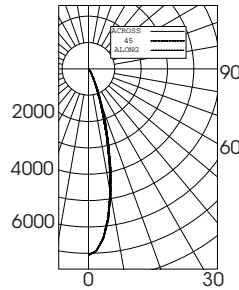

Candelas at Nadir	
Deg	Candela
0	6950
5	6511
15	2927
25	622
35	112
45	45

WIDE FLOOD 45°  
DISTRIBUTION  
LTL # 227696

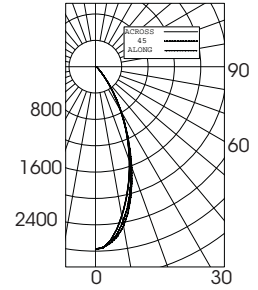

Candelas at Nadir	
Deg	Candela
0	2773
5	2688
15	2067
25	1154
35	453
45	132

**APPLICATION DATA:**

**Notes and Definitions:**

Beam spread is to 50% center beam candlepower (CBCP).  
 D=Distance to floor or wall.  
 FC=Footcandles on floor or wall at center beam aiming location.  
 L=Effective Visual Beam length in feet (50% of maximum footcandle level).  
 W=Effective Visual Beam width in feet (50% of maximum footcandle level).  
 CB=Distance across or down to center beam location.

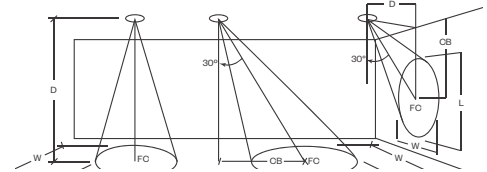

	0° Aiming Angle Horizontal Footcandles				30° Aiming Angle Horizontal Footcandles					30° Aiming Angle Vertical Footcandles					60° Aiming Angle Vertical Footcandles				
	D	FC	L	W	D	FC	L	W	CB	D	FC	L	W	CB	D	FC	L	W	CB
NARROW FLOOD	5.0'	565	1.7	1.6	5.0'	415	2.1	1.8	3.0	3.0'	278	3.0	1.8	5.0	3.0'	767	1.6	1.4	2.0
	7.5'	322	2.3	2.2	7.5'	232	2.8	2.5	4.0	4.0'	173	3.9	2.2	6.0	4.0'	563	2.0	1.5	5.0
	10.0'	200	2.9	2.8	10.0'	132	3.7	3.2	6.0	5.0'	119	4.6	2.7	8.0	5.0'	414	2.2	1.8	3.0
	12.5'	134	3.4	3.3	12.5'	91	4.4	3.8	7.0	6.0'	85	5.5	3.1	9.0	6.0'	300	2.5	2.1	3.0
MEDIUM FLOOD	5.0'	293	2.5	2.4	5.0'	197	3.1	2.7	3.0	3.0'	154	3.6	2.3	4.0	3.0'	449	2.1	1.7	2.0
	7.5'	141	3.4	3.3	7.5'	98	4.3	3.7	4.0	4.0'	90	4.7	3.0	5.0	4.0'	316	2.4	2.1	2.0
	10.0'	81	4.6	4.5	10.0'	56	5.7	4.9	5.0	5.0'	58	5.8	3.7	7.0	5.0'	198	3.1	2.7	3.0
	12.5'	52	5.7	5.5	12.5'	36	7.1	6.2	6.0	6.0'	42	7.0	4.4	8.0	6.0'	149	3.5	3.0	3.0
FLOOD	5.0'	253	2.5	2.4	5.0'	170	3.1	2.7	3.0	3.0'	137	3.5	2.4	4.0	3.0'	390	2.1	1.8	2.0
	7.5'	121	3.5	3.4	7.5'	85	4.4	3.7	4.0	4.0'	81	4.5	3.0	5.0	4.0'	274	2.4	2.2	2.0
	10.0'	70	4.7	4.5	10.0'	49	5.7	4.9	5.0	5.0'	52	5.6	3.8	6.0	5.0'	171	3.2	2.7	3.0
	12.5'	45	5.8	5.5	12.5'	32	7.2	6.1	6.0	6.0'	37	6.8	4.4	8.0	6.0'	130	3.6	3.1	3.0
WIDE FLOOD	5.0'	113	3.6	3.5	5.0'	83	4.1	3.7	2.0	3.0'	80	3.8	3.1	3.0	3.0'	198	2.7	2.5	1.0
	7.5'	51	5.3	5.1	7.5'	38	6.1	5.5	3.0	4.0'	47	4.8	3.9	4.0	4.0'	128	3.3	3.2	2.0
	10.0'	29	7.1	6.8	10.0'	22	8.0	7.3	4.0	5.0'	30	6.0	4.9	5.0	5.0'	85	4.1	3.7	2.0
	12.5'	18	8.9	8.5	12.5'	14	10.3	9.4	5.0	6.0'	21	7.3	6.0	6.0	6.0'	57	5.0	4.6	2.0

# CONTOUR VERTICAL 4X4

TRACK LED

CNTRV44  
LED



TYPE:

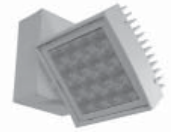

ENERGY STAR APPROVED MODEL NUMBERS:



## Certificate of Conformance

### Energy Efficiency Certification

UL conducted an independent evaluation on behalf of:

**AMERLUX L L C**

23 DANIEL RD, FAIRFIELD, NJ 07004-2527

for the following products:

Directional Luminaires

Brand: Amerlux

Model: See Appendix A

This product meets all of the necessary qualifications pursuant to:

ENERGY STAR®: Program Requirements for Luminaires, Version 2.0



2017-02-27

Certification Date

N/A

Certification Revision Date

*[Signature]*

Issued by

11628405

UL Product Number

00-VS-F0418, Version 3.0. This is to certify that representative samples of the Certified Product(s) listed above have been investigated by UL to the Standard(s) indicated on this certificate, in accordance with the UL Global Services Agreement and the EEC Terms & Conditions ("Agreement"). The Certificate Holder is entitled to use the UL Energy Verified Mark for the Certified Product(s) listed on the certificate and manufactured at the production site(s) covered by the UL Test Report, in accordance with the terms of the Agreement. This Certificate shall remain valid unless a Standard identified on this Certificate is amended or withdrawn prior to that date or these is a non-compliance with the Agreement.

#### Appendix A

Model Name	Model Number	Family Model(s) - Additional Model Number
Contour	CNTR*44-32-LED-E-**-***-###-***-3000-**	CNTR*44-32-LED-E-**-***-###-***-3500-**
		CNTR*44-32-LED-E-**-***-###-***-4000-**