

LINEA® 1.5"

LINEAR DIRECT LED, REMOTE DRIVER

APPLICATIONS:

Commercial and retail direct ambient lighting

CONSTRUCTION:

One piece extruded aluminum housing
Internal components are die-formed galvanized and cold-rolled steel
Individual housing lengths are 47 3/4" or 95 1/4"
Continuous rows can be provided to the nearest foot
High reflectance white finish. For other finishes, consult factory

MOUNTING:

Aircraft cable suspension
Fixtures may be continuously row-mounted or configured in a pattern, consult factory

LABELING:



For indoor use only

OPTICS:

Watts	Lumens (lens direct)
5w/ft	460 lm/ft
10w/ft	815 lm/ft

Die-formed high reflectance white enamel reflector
Lens: 100% extruded acrylic lens with custom formulation for lamp image diffusion and maximum light transmission. Flush mount snap-in installation.

Louver (optional):

Straight blade louver, 1/2" high, 1/2" o.c., with overlay.

ELECTRICAL:

Electronic, multi-volt (120v-277v) constant current driver, remote mounted
0-10v dimming standard

This product complies with IEEE C62.41 for surge endurance up to 3KV. Amerlux® recommends using additional surge protection with this unit (supplied by others), surge damage is not covered by warranty.

Emergency circuit via remote inverter or auxiliary emergency power supply (by others)

LIN1.5-D-REMOTE LED



PROJECT:

TYPE:

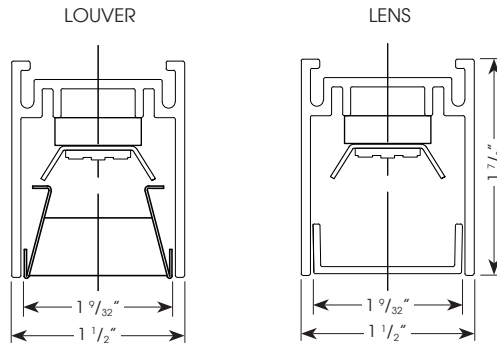

ASYMMETRIC LENS:



For Asymmetric distribution this should be opposite the wall

ELECTRICAL

Electronic driver

Wattage per foot	4'		8'	
	System watts	Amps	System watts	Amps
5	120v	20	40	.33
	277v	20	40	.14
10	120v	40	80	.67
	277v	40	80	.29



Electrostatic sensitive device, observe precautions for handling



Enlighted Sensor (optional)

10 year limited warranty
AMERLUX LED
(see website for details)

ORDERING INFORMATION:

Model	Light Distr./Shielding	Mounting	Wattage	Lamp Type	Color Temp	Finish	Voltage	Length	Configuration	Options
LIN1.5-D-REMOTE	LD - lens direct	ASW10 - aircraft	5	LED	2700	HW - high	120/277	4	IND - individual	HILUME-DH - Lutron
	SLD - straight blade louver direct with overlay, specify color: B (blk), S (slv), W (wh)	cable with straight feed, (18ga., 5 conductor), white, 10'	10		3000 3500 4000	reflectance white white (other RAL)		8	BOR - beginning of run MOR - middle of run EOR - end of run	Hi-lume® 3 wire, 1% dim HILUME-ECO - Lutron Hi-lume® EcoSystem, 1% dim ENLF - Enlighted Sensor
	ASY - asymmetric lens							(run to nearest foot)		

Example: LIN1.5-D-REMOTE-SLDB-ASW10-10-LED-3500-HW-120/277-4-IND

Cat #:

Amerlux reserves the right to change details that do not affect overall function and performance.

LINEA® 1.5"

LINEAR DIRECT LED, REMOTE DRIVER

LIN1.5-D-REMOTE
LED



TYPE:



STANDARD PLACEMENT(S) FOR (OPTIONAL) ENLIGHTENED SENSOR:

4 FT OR 8 FT DIRECT

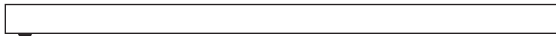

Optional Enlighted Sensor

RUNS

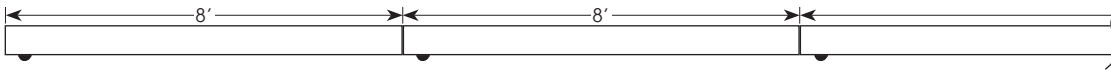

LINEA® 1.5"

LINEAR DIRECT LED, REMOTE DRIVER

LIN1.5-D-REMOTE
LED



TYPE:



FIXTURE DATA:

Complete photometric data (ies format) available upon request.

LENS DIRECT

LINEA 1.5" 5W LED 4FT 3500K
SOURCE: 96 WHITE LEDS LUMENS: 1840
PENDANT

LINEA 1.5" 10W LED 4FT 3500K
SOURCE: 96 WHITE LEDS LUMENS: 3263
PENDANT

LTL# 695285

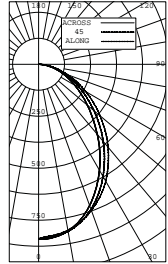

ZONAL LUMEN SUMMARY

Zone	Lumens	%Fixt
0-30	614	33.36
0-40	958	52.08
0-60	1535	83.42
0-90	1840	100.00
40-90	882	47.92
60-90	305	16.58
90-180	0	0.00
0-180	1840	100.00

Efficacy = 87.6 Lumens /Watt

COEFFICIENTS OF UTILIZATION

Effective Floor Cavity Reflectance 20%

RC	80			
RW	70	50	30	10
RCR				
0	1.19	1.19	1.19	1.19
1	1.10	1.06	1.03	0.99
2	1.02	0.95	0.89	0.8
3	0.94	0.85	0.78	0.72
4	0.88	0.77	0.69	0.64
5	0.81	0.70	0.62	0.56
6	0.75	0.63	0.55	0.49
7	0.69	0.57	0.49	0.44
8	0.65	0.52	0.44	0.39
9	0.60	0.48	0.40	0.35
10	0.56	0.44	0.36	0.31

LTL# 695286

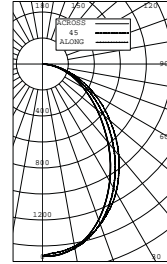

ZONAL LUMEN SUMMARY

Zone	Lumens	%Fixt
0-30	1082	33.16
0-40	1691	51.83
0-60	2716	83.25
0-90	3263	100.00
40-90	1572	48.17
60-90	547	16.75
90-180	0	0.00
0-180	3263	100.0

Efficacy = 78.4 Lumens /Watt

COEFFICIENTS OF UTILIZATION

Effective Floor Cavity Reflectance 20%

RC	80			
RW	70	50	30	10
RCR				
0	1.19	1.19	1.19	1.19
1	1.10	1.06	1.03	0.99
2	1.02	0.95	0.89	0.84
3	0.94	0.85	0.78	0.72
4	0.87	0.77	0.69	0.63
5	0.81	0.70	0.61	0.55
6	0.75	0.63	0.55	0.49
7	0.69	0.57	0.49	0.43
8	0.65	0.52	0.44	0.39
9	0.60	0.48	0.40	0.34
10	0.56	0.44	0.36	0.31

STRAIGHT BLADE LOUVER DIRECT

LINEA 1.5" 5W LED 4FT 3500K
SOURCE: 96 WHITE LEDS LUMENS: 909
PENDANT

LINEA 1.5" 10W LED 4FT 3500K
SOURCE: 96 WHITE LEDS LUMENS: 1599
PENDANT

LTL# 695287

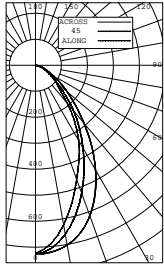

ZONAL LUMEN SUMMARY

Zone	Lumens	%Fixt
0-30	443	48.71
0-40	633	69.58
0-60	842	92.63
0-90	909	100.00
40-90	277	30.42
60-90	67	7.37
90-180	0	0.00
0-180	909	100.00

Efficacy = 43.3 Lumens /Watt

COEFFICIENTS OF UTILIZATION

Effective Floor Cavity Reflectance 20%

RC	80			
RW	70	50	30	10
RCR				
0	1.19	1.19	1.19	1.19
1	1.12	1.09	1.06	1.04
2	1.06	1.00	0.96	0.92
3	0.99	0.92	0.87	0.82
4	0.94	0.85	0.79	0.74
5	0.88	0.79	0.72	0.67
6	0.83	0.73	0.66	0.62
7	0.78	0.68	0.61	0.56
8	0.74	0.63	0.56	0.52
9	0.69	0.58	0.52	0.47
10	0.65	0.54	0.48	0.43

LTL# 695288

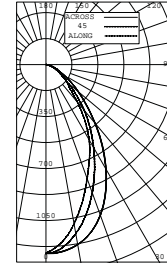

ZONAL LUMEN SUMMARY

Zone	Lumens	%Fixt
0-30	776	48.51
0-40	1109	69.33
0-60	1479	92.46
0-90	1599	100.00
40-90	491	30.67
60-90	121	7.54
90-180	0	0.00
0-180	1599	100.0

Efficacy = 38.4 Lumens /Watt

COEFFICIENTS OF UTILIZATION

Effective Floor Cavity Reflectance 20%

RC	80			
RW	70	50	30	10
RCR				
0	1.19	1.19	1.19	1.19
1	1.12	1.09	1.06	1.03
2	1.06	1.00	0.96	0.92
3	0.99	0.92	0.86	0.82
4	0.94	0.85	0.79	0.74
5	0.88	0.79	0.72	0.67
6	0.83	0.73	0.66	0.62
7	0.78	0.67	0.61	0.56
8	0.73	0.63	0.56	0.51
9	0.69	0.58	0.52	0.47
10	0.65	0.54	0.48	0.43

LINEA® 1.5"

LINEAR DIRECT LED, REMOTE DRIVER

LINEA 1.5-D-REMOTE LED



TYPE:



FIXTURE DATA:

Complete photometric data (ies format) available upon request.

ASYMMETRIC LENS

LINEA 1.5" 5W LED 4FT 3000K
SOURCE: 96 WHITE LEDS LUMENS: 1649
PENDANT

LINEA 1.5" 10W LED 4FT 3000K
SOURCE: 96 WHITE LEDS LUMENS: 3002
PENDANT

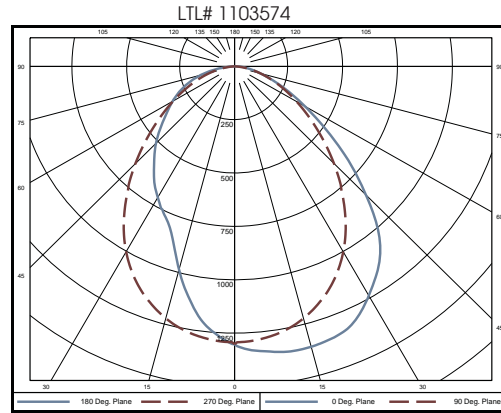
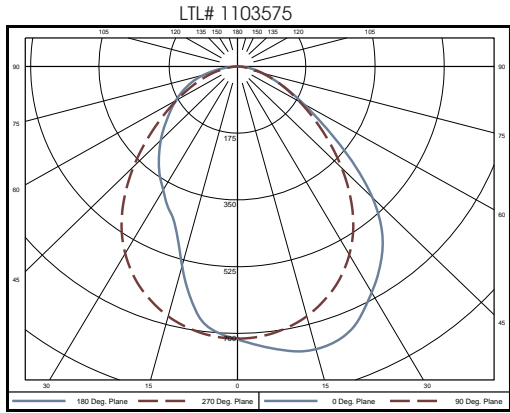

ZONAL LUMEN SUMMARY

Zone	Lumens	%Fixt
0-40	836	50.7
0-60	1376	83.4
0-90	1649	100.00
90-180	0	0.00

Efficacy = 85.4 Lumens /Watt

COEFFICIENTS OF UTILIZATION

Effective Floor Cavity Reflectance 20%

RC	80			
	70	50	30	10
RW				
RCR				
0	1963	1963	1963	1963
1	1807	1734	1668	1609
2	1654	1527	1421	1332
3	1517	1352	1225	1124
4	1395	1207	1069	964
5	1288	1085	943	839
6	1193	982	840	739
7	1109	894	755	658
8	1035	819	684	591
9	969	754	623	535
10	910	698	571	487

ZONAL LUMEN SUMMARY

Zone	Lumens	%Fixt
0-40	1508	50.2
0-60	2494	83.1
0-90	3002	100.00
90-180	0	0.00

Efficacy = 77.5 Lumens /Watt

COEFFICIENTS OF UTILIZATION

Effective Floor Cavity Reflectance 20%

RC	80			
	70	50	30	10
RW				
RCR				
0	3574	3574	3574	3574
1	3287	3153	3033	2925
2	3008	2774	2581	2419
3	2756	2456	2223	2038
4	2534	2190	1939	1746
5	2339	1968	1709	1518
6	2166	1780	1522	1336
7	2013	1621	1367	1188
8	1878	1484	1237	1067
9	1758	1366	1127	965
10	1651	1264	1033	879