

# CYLINDRIX III MINI

## VERTICAL TRACK ACCENT LED

### APPLICATION

Accent and display lighting for retail, supermarket, commercial & hospitality environments

### CONSTRUCTION:

Complete die-cast construction  
No exposed wiring  
Powder coat paint

### ELECTRICAL:

Electronic constant current LED driver, 120V - 277V input  
ELV and Triac dimming standard, 120V & 277V.  
See following pages for more information.

**This product complies with IEEE C62.41 for surge endurance up to 2.5KV. Amerlux® recommends using additional surge protection with this unit (supplied by others), surge damage is not covered by warranty.**

### OPTICS:

0-180° tilt, 360° rotation  
Available in a variety of beam spreads  
LED:  
Color Temp Options: 2200K, 2700K, 3000K, 3500K, 4000K  
CRI: 83 typ. (2700K, 3000K, 3500K, 4000K)  
90+ typ. (2200K, 2700K, 3000K, 3500K)  
CrispWhite & Class A LED available  
R9 Values: 11 (83CRI), 55 (92CRI)  
Binning: 3 MacAdam  
Lumen Maintenance: >70% of initial lumens @ 50,000 hrs  
Lumen Output (21W, 3000K): 1850 lm (89.6 lpw)  
CBCP (3000K): SP (21W) 13,578  
VNSP (18W only) 24,308

### MOUNTING:

Track, canopy, c-clamp and busway  
**Note: Ceiling mounted track only**

### LABELING:



Dry location

C3MV  
LED



PROJECT:

TYPE:



Electrostatic sensitive device,  
observe precautions for  
handling

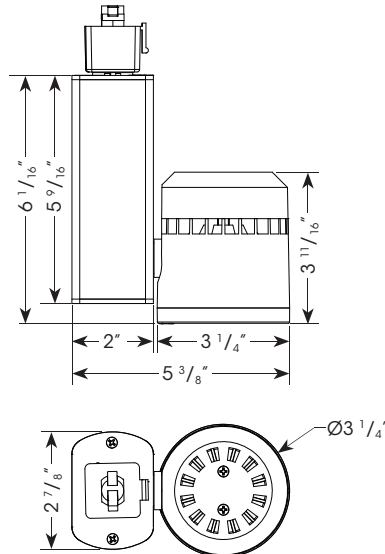
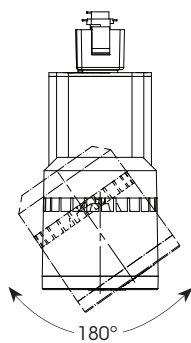

### ELECTRICAL

Electronic driver

	15W		18W		21W		28W	
	System Watts	Amps	System Watts	Amps	System Watts	Amps	System Watts	Amps
120V	15	0.13	18	0.15	21	0.18	28	0.23
277V	15	0.05	18	0.06	21	0.08	28	0.10

### ORDERING INFORMATION:

Model	Wattage	Lamp Type	Finish	Mounting	Voltage	Beam Spread	Color Temp (CCT-CRI)	Options/ Accessories
C3MV	15 21 28	LED	WT - white texture BT - black texture ST - silver texture - - (other RAL)	TN1 - Global GES 1cir/H-Style, 120V TEK - Global TEK 2cir/2neut, 120V TN3 - Global XTS 3cir, 120V TN2 - Global HTEK 2cir/2neut, 277V CT - J-Style LOL - L-Style CPR - Capri/Prescolite compatible LLAB - Litelab Bus Run, 120V B - busway (compact series B40,B60c only, consult factory for other busway adapters) C - canopy CCL2 - C-clamp with SCP - straight cord, 6' CCP - coil cord, 5'	120 277	SP - spot, 14° VNF - very narrow flood, 18° NF - narrow flood, 23° FL - flood, 34° WF - wide flood, 44°  VNSP - very narrow spot, 8° (18w only)	27 - 2700-83 30 - 3000-83 35 - 3500-83 40 - 4000-83 229 - 2200-90+ 279 - 2700-90+ 309 - 3000-90+ 359 - 3500-90+ 409 - 4000-90+ 3CLA - 3K Class A CRISP - CrispWhite (not for VNSP)	SN - snoot LS - linear spread HEX - hexcel louver CB - cross blade, matte black, requires snoot SOL - solite beam softening lens

Example: C3MV-21-LED-WT-TN1-120-FL-30

Cat #:

Amerlux reserves the right to change details that do not affect overall function and performance.

# CYLINDRIX III MINI

VERTICAL TRACK ACCENT LED

C3MV  
LED



TYPE:



**FIXTURE DATA:** For 15W data, multiply by 0.71; For 18W data see next page; For 28W data, multiply by 1.23 Complete photometric data (ies format) available upon request.  
CCT Correction Factors: 2700-83 = 0.96; 3500-83 = 1.02; 4000-83 = 1.04; 2200-90+ = 0.71; 2700-90+ = 0.80; 3000-90+ = 0.83; 3500-90+ = 0.87; Crisp = 0.65

## 21W LED (3000K-83)

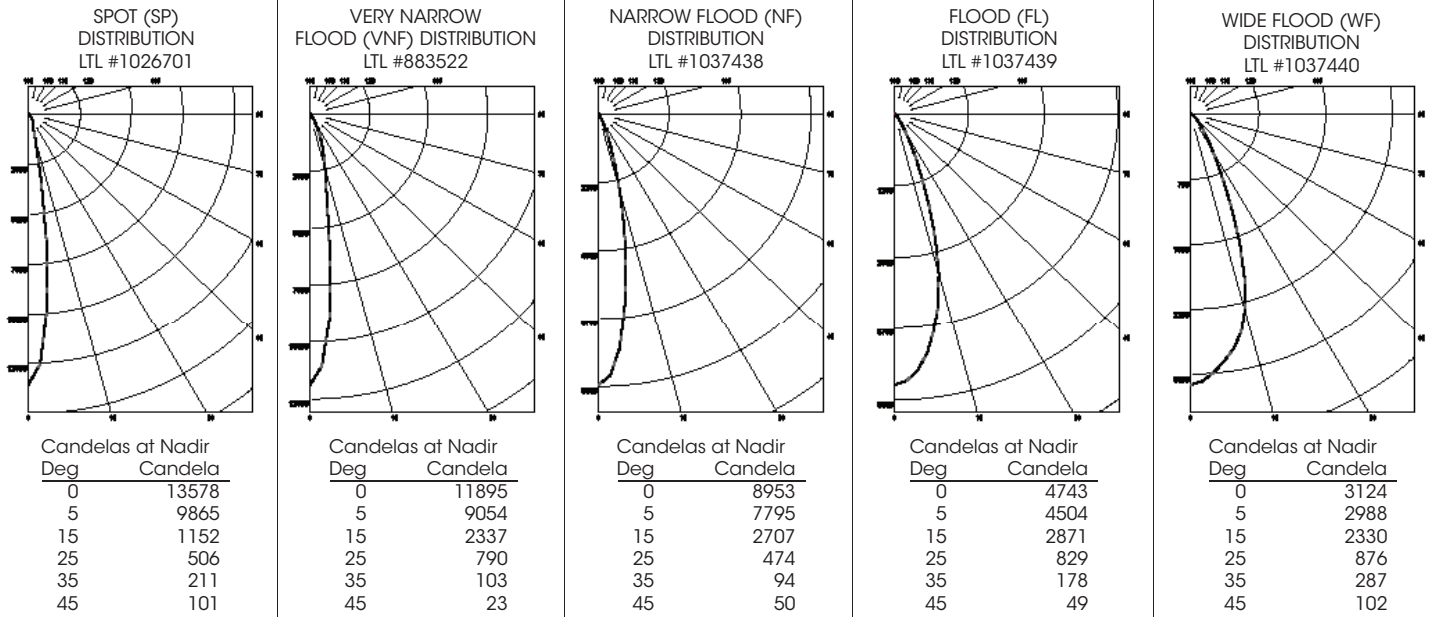

## APPLICATION DATA:

### Notes and Definitions:

Beam spread is to 50% center beam candlepower (CBCP).  
D=Distance to floor or wall.  
FC=Footcandles on floor or wall at center beam aiming location.  
L=Effective Visual Beam length in feet (50% of maximum footcandle level).  
W=Effective Visual Beam width in feet (50% of maximum footcandle level).  
CB=Distance across or down to center beam location.

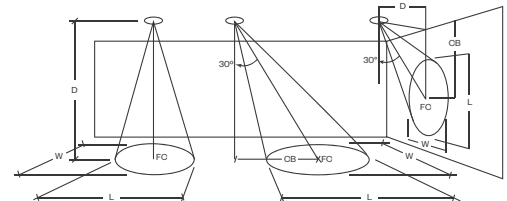

	0° Aiming Angle Horizontal Footcandles				30° Aiming Angle Horizontal Footcandles					30° Aiming Angle Vertical Footcandles					60° Aiming Angle Vertical Footcandles				
	D	FC	L	W	D	FC	L	W	CB	D	FC	L	W	CB	D	FC	L	W	CB
SPOT	5.0'	540	1.2	1.2	5.0'	348	1.6	1.4	3.0	3.0'	200	2.8	1.4	5.0	3.0'	726	1.3	1.1	2.0
	7.5'	241	1.8	1.8	7.5'	155	2.5	2.2	4.0	4.0'	121	3.5	1.8	6.0	4.0'	518	1.5	1.2	2.0
	10.0'	136	2.6	2.6	10.0'	85	3.4	3.0	6.0	5.0'	77	4.3	2.5	8.0	5.0'	334	1.8	1.3	3.0
	12.5'	87	3.2	3.2	12.5'	57	4.2	3.6	7.0	6.0'	54	5.2	2.9	9.0	6.0'	230	2.2	1.6	3.0
VERY NARROW FLOOD	5.0'	473	1.4	1.4	5.0'	305	1.9	1.5	3.0	3.0'	176	3.4	1.5	5.0	3.0'	651	1.6	1.2	2.0
	7.5'	211	2.1	2.1	7.5'	136	2.9	2.5	4.0	4.0'	108	4.1	2.0	6.0	4.0'	462	1.6	1.3	2.0
	10.0'	119	2.9	2.9	10.0'	75	3.8	3.3	6.0	5.0'	67	5.3	2.8	8.0	5.0'	293	2.0	1.5	3.0
	12.5'	76	3.5	3.5	12.5'	50	4.7	3.9	7.0	6.0'	49	6.3	3.2	9.0	6.0'	206	2.4	1.8	3.0
NARROW FLOOD	5.0'	358	1.9	1.9	5.0'	257	2.4	2.1	3.0	3.0'	181	3.2	1.8	4.0	3.0'	620	1.9	1.2	2.0
	7.5'	159	2.9	2.9	7.5'	115	3.5	3.2	4.0	4.0'	96	4.4	2.8	6.0	4.0'	426	1.9	1.5	2.0
	10.0'	90	3.8	3.8	10.0'	63	4.8	4.2	5.0	5.0'	63	5.3	3.3	7.0	5.0'	249	2.5	2.2	3.0
	12.5'	58	4.8	4.8	12.5'	40	6.1	5.4	7.0	6.0'	43	6.7	4.0	8.0	6.0'	182	2.9	2.6	3.0
FLOOD	5.0'	190	2.9	2.9	5.0'	130	3.5	3.1	2.0	3.0'	113	3.4	2.7	3.0	3.0'	340	2.3	1.8	1.0
	7.5'	85	4.3	4.3	7.5'	58	5.2	4.8	3.0	4.0'	64	4.6	3.5	4.0	4.0'	208	2.8	2.6	2.0
	10.0'	48	5.7	5.7	10.0'	34	6.8	6.4	5.0	5.0'	41	5.8	4.4	5.0	5.0'	133	3.5	3.1	2.0
	12.5'	31	7.2	7.2	12.5'	22	8.5	8.0	6.0	6.0'	29	7.0	5.2	7.0	6.0'	93	4.1	3.8	3.0
WIDE FLOOD	5.0'	125	3.3	3.3	5.0'	92	3.9	3.5	2.0	3.0'	92	3.2	2.7	3.0	3.0'	254	2.3	2.0	1.0
	7.5'	56	5.0	5.0	7.5'	41	5.6	5.4	3.0	4.0'	52	4.3	3.6	4.0	4.0'	138	3.2	3.0	2.0
	10.0'	32	6.7	6.7	10.0'	23	7.6	7.3	4.0	5.0'	34	5.3	4.6	5.0	5.0'	93	3.9	3.5	2.0
	12.5'	20	8.5	8.5	12.5'	15	9.6	9.2	5.0	6.0'	23	6.5	5.5	6.0	6.0'	64	4.7	4.5	2.0

# CYLINDRIX III MINI

VERTICAL TRACK ACCENT LED

C3MV  
LED



TYPE:



**FIXTURE DATA:**

Complete photometric data (ies format) available upon request.

CCT Correction Factors: 2700-83 = 0.96; 3500-83 = 1.02; 4000-83 = 1.04; 2200-90+ = 0.71; 2700-90+ = 0.80; 3000-90+ = 0.83; 3500-90+ = 0.87; Crisp = 0.65

**18W LED (3000K-83)**

VERY NARROW SPOT (VNSP)  
DISTRIBUTION  
LTL #1170140

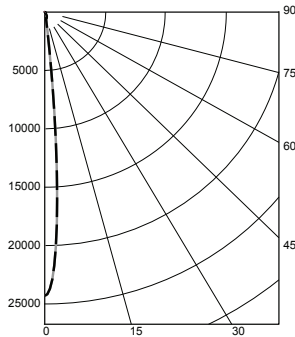

Candelas at Nadir	Deg	Candela
	0	24308
	5	8980
	15	527
	25	394
	35	131
	45	57

**APPLICATION DATA:**

**Notes and Definitions:**

Beam spread is to 50% center beam candlepower (CBCP).  
 D=Distance to floor or wall.  
 FC=Footcandles on floor or wall at center beam aiming location.  
 L=Effective Visual Beam length in feet (50% of maximum footcandle level).  
 W=Effective Visual Beam width in feet (50% of maximum footcandle level).  
 CB=Distance across or down to center beam location.

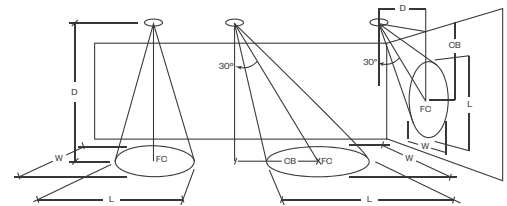

0° Aiming Angle  
Horizontal  
Footcandles



30° Aiming Angle  
Horizontal  
Footcandles



30° Aiming Angle  
Vertical  
Footcandles



60° Aiming Angle  
Vertical  
Footcandles

VERY NARROW SPOT	0° Aiming Angle Horizontal Footcandles				30° Aiming Angle Horizontal Footcandles					30° Aiming Angle Vertical Footcandles					60° Aiming Angle Vertical Footcandles				
	D	FC	L	W	D	FC	L	W	CB	D	FC	L	W	CB	D	FC	L	W	CB
	5.0'	967	1.0	1.0	5.0'	624	1.0	1.0	3.0	3.0'	360	1.5	1.0	5.0	3.0'	983	1.0	1.0	2.0
	7.5'	431	1.1	1.1	7.5'	251	1.8	1.1	4.0	4.0'	185	2.4	1.1	7.0	4.0'	729	1.1	1.0	2.0
	10.0'	243	1.3	1.3	10.0'	153	2.1	1.6	6.0	5.0'	129	2.7	1.2	8.0	5.0'	600	1.1	1.0	3.0
	12.5'	156	1.8	1.8	12.5'	102	2.4	2.2	7.0	6.0'	90	3.3	1.6	10.0	6.0'	325	1.9	1.0	3.0

# CYLINDRIX III MINI

VERTICAL TRACK ACCENT LED

C3MV  
LED



TYPE:



**DIMMING COMPATIBILITY:**

Amerlux® fixtures are compatible with all major dimming protocols prevalent in the United States. Please see below for general compatibilities and wiring diagrams. Amerlux recommends testing your unique dimming configuration as the exact full configuration (Dimmer, Fixture Quantity, Voltage, etc) may affect dimming performance.

**TRIAC (Forward Phase) DIMMING (standard)**

Utilizes "Standard" incandescent dimmers that are in wide use in installations across the US. Best for retrofit applications where Triac dimmers are installed.

**Notes:**

- 120V & 277V
- Dims down to less than 5% light output (most cases)
- Consult Dimming manufacturer for installation instructions - **DO NOT SHARE NEUTRALS!**
- Must meet dimmer Minimum Load Requirements per dimming manufacturer

**Wiring Diagram**

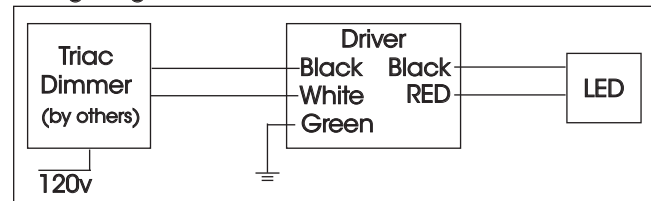

**Compatible Dimmers**

**Wall Box (Incandescent Style, Wattage as required)**

Lutron "Diva"  
Lutron "Nova-T"  
Lutron "Maestro"

Lutron "Vareo"  
Lutron "Skylark"

**Central System**

ETC "SR" Rack w/D20 Module  
Lutron "GP" Panel

ETC "DRD" Rack w/D20 Module  
Lutron Grafix Eye QS

**ELV - Electronic Low Voltage (Reverse Phase) DIMMING (standard)**

Utilizes specialized "ELV" dimmers. Best for New Construction applications

**Notes:**

- 120V & 277V
- Dims down to less than 5% light output (most cases)
- Consult Dimming manufacturer for installation instructions - **DO NOT SHARE NEUTRALS!**
- Must meet dimmer Minimum Load Requirements

**Wiring Diagram**

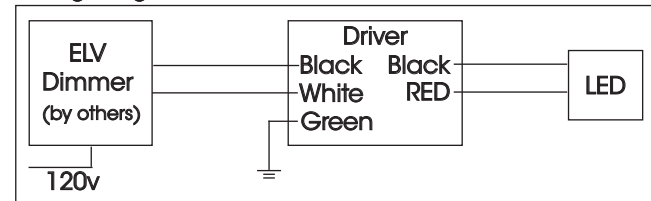

**Compatible Dimmers**

**Wall Box (ELV Style)**

Lutron "Diva"  
Lutron "Nova-T"  
Lutron "Maestro"  
Leviton "Surslide"

Lutron "Vareo"  
Lutron "Skylark"  
Leviton "Vizio"

**Central System**

ETC "SR" Rack w/ELV10 Module  
Lutron "GP" Panel with PHPM-PA Interface

ETC "DRD" Rack w/ELV10 Module  
Lutron Grafix Eye QS with PHPM-PA Interface