

CYLINDRIX III MINI

VERTICAL TRACK ACCENT LED

APPLICATION

Accent and display lighting for retail, supermarket, commercial & hospitality environments

CONSTRUCTION:

Complete die-cast construction
No exposed wiring
Powder coat paint

ELECTRICAL:

Electronic constant current LED driver, 120V - 277V input
ELV and Triac dimming standard, 120Vv & 277V.
See following pages for more information.

This product complies with IEEE C62.41 for surge endurance up to 2.5KV. Amerlux® recommends using additional surge protection with this unit (supplied by others), surge damage is not covered by warranty.

OPTICS:

0-180° tilt, 360° rotation
Available in a variety of beam spreads
LED:
Color Temp Options: 2200K, 2700K, 3000K, 3500K, 4000K
CRI: 83 typ. (2700K, 3000K, 3500K, 4000K)
90+ typ. (2200K, 2700K, 3000K, 3500K)
CrispWhite & Class A LED available
R9 Values: 11 (83CRI), 55 (92CRI)
Binning: 3 MacAdam
Lumen Maintenance: >70% of initial lumens @ 50,000 hrs
Lumen Output (21W, 3000K): 1850 lm (89.6 lpw)
CBCP (3000K): SP (21W) 13,578
VNSP (18W only) 24,308

MOUNTING:

Track, canopy, c-clamp and busway
Note: Ceiling mounted track only

LABELING:



Dry location

C3MV
LED



PROJECT:

TYPE:

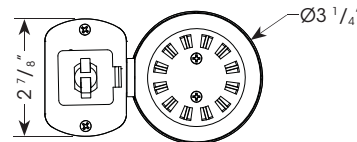
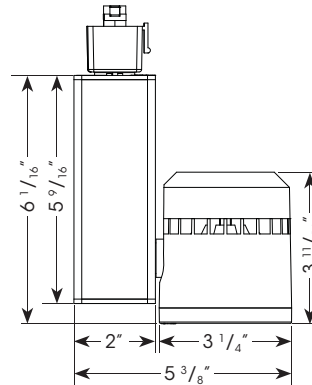
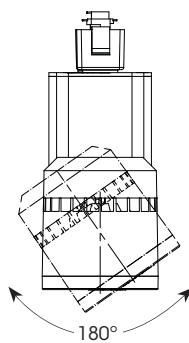

Title 24
Compliant

ELECTRICAL

Electronic driver

| | 15W | | 18W | | 21W | | 28W | |
|------|-----------------|------|-----------------|------|-----------------|------|-----------------|------|
| | System Watts | Amps | System Watts | Amps | System Watts | Amps | System Watts | Amps |
| 120V | 15 | 0.13 | 18 | 0.15 | 21 | 0.18 | 28 | 0.23 |
| 277V | 15 | 0.05 | 18 | 0.06 | 21 | 0.08 | 28 | 0.10 |

ORDERING INFORMATION:

| Model | Wattage | Lamp Type | Finish | Mounting | Voltage | Beam Spread | Color Temp (CCT-CRI) | Options/ Accessories |
|-------|-----------------|-----------|--------------------------------------------------------------------------|----------------------------------------------------------------------------------------------------------------------------------------------------------------------------------------------------------------------------------------------------------------------------------------------------------------------------------------------------------|------------|----------------------------------------------------------------------------------------------------------------------------------------------------------------------|---------------------------------------------------------------------------------------------------------------------------------------------------------------------------------------------------------------------|-------------------------------------------------------------------------------------------------------------------------------------------------------|
| C3MV | 15 21 28* | LED | WT - white texture BT - black texture ST - silver texture | TN1 - Global GES 1cir/H-Style, 120V TEK - Global TEK 2cir/2neut, 120V TN3 - Global XTS 3cir, 120V TN2 - Global HTEK 2cir/2neut, 277V CT - J-Style LOL - L-Style CPR - Capri/Prescolite compatible LLAB - Litalab Bus Run, 120V B - busway C - canopy CCL2 - C-clamp with SCP - straight cord, 6' CCP - coil cord, 5' | 120 277 | SP - spot, 14° VNF - very narrow flood, 18° NF - narrow flood, 23° FL - flood, 34° WF - wide flood, 44° VNSP - very narrow spot, 8° (18w only) | 27 - 2700-83 30 - 3000-83 35 - 3500-83 40 - 4000-83 229 - 2200-90+ 279 - 2700-90+ 309 - 3000-90+ 359 - 3500-90+ 409 - 4000-90+ 3CLA - 3K Class A CRISP - CrispWhite (not for VNSP) | SN - snoot LS - linear spread HEX - hexcel louver CB - cross blade, matte black, requires snoot SOL - solite beam softening lens |
| | 18 (8° only) | | (other RAL) | | | | | |

*Not Title 24 Compliant

Example: C3MV-21-LED-WT-TN1-120-FL-30

Cat #:

Amerlux reserves the right to change details that do not affect overall function and performance.

CYLINDRIX III MINI

VERTICAL TRACK ACCENT LED

C3MV
LED



TYPE:



FIXTURE DATA: For 15W data, multiply by 0.71; For 18W data see next page

Complete photometric data (ies format) available upon request.

CCT Correction Factors: 2700-83 = 0.96; 3500-83 = 1.02; 4000-83 = 1.04; 2200-90+ = 0.71; 2700-90+ = 0.80; 3000-90+ = 0.83; 3500-90+ = 0.87; Crisp = 0.65

21W LED (3000K-83)

SPOT (SP)
DISTRIBUTION
LTL #1026701

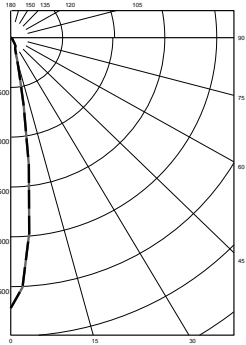

| Candelas at Nadir | |
|-------------------|---------|
| Deg | Candela |
| 0 | 13578 |
| 5 | 9865 |
| 15 | 1152 |
| 25 | 506 |
| 35 | 211 |
| 45 | 101 |

VERY NARROW FLOOD (VNF) DISTRIBUTION
LTL #883522

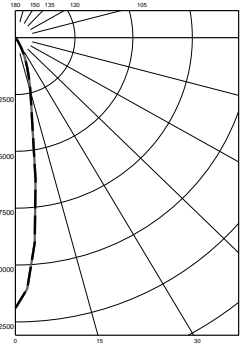

| Candelas at Nadir | |
|-------------------|---------|
| Deg | Candela |
| 0 | 11895 |
| 5 | 9054 |
| 15 | 2337 |
| 25 | 790 |
| 35 | 103 |
| 45 | 23 |

NARROW FLOOD (NF) DISTRIBUTION
LTL #1037438

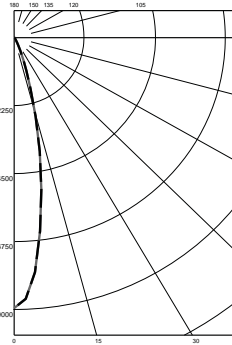

| Candelas at Nadir | |
|-------------------|---------|
| Deg | Candela |
| 0 | 8953 |
| 5 | 7795 |
| 15 | 2707 |
| 25 | 474 |
| 35 | 94 |
| 45 | 50 |

FLOOD (FL) DISTRIBUTION
LTL #1037439

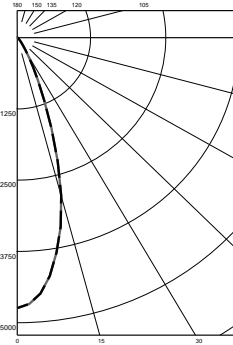

| Candelas at Nadir | |
|-------------------|---------|
| Deg | Candela |
| 0 | 4743 |
| 5 | 4504 |
| 15 | 2871 |
| 25 | 829 |
| 35 | 178 |
| 45 | 49 |

WIDE FLOOD (WF) DISTRIBUTION
LTL #1037440

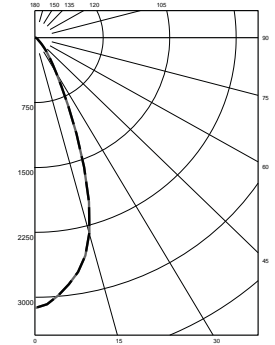

| Candelas at Nadir | |
|-------------------|---------|
| Deg | Candela |
| 0 | 3124 |
| 5 | 2988 |
| 15 | 2330 |
| 25 | 876 |
| 35 | 287 |
| 45 | 102 |

APPLICATION DATA:

Notes and Definitions:

Beam spread is to 50% center beam candlepower (CBCP).
 D=Distance to floor or wall.
 FC=Footcandles on floor or wall at center beam aiming location.
 L=Effective Visual Beam length in feet (50% of maximum footcandle level).
 W=Effective Visual Beam width in feet (50% of maximum footcandle level).
 CB=Distance across or down to center beam location.

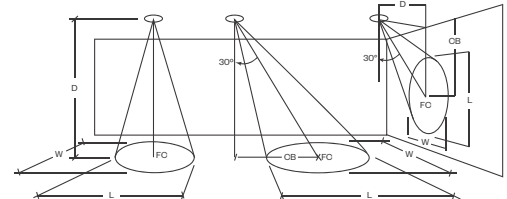

0° Aiming Angle
Horizontal
Footcandles



30° Aiming Angle
Horizontal
Footcandles



30° Aiming Angle
Vertical
Footcandles



60° Aiming Angle
Vertical
Footcandles

| | 0° Aiming Angle Horizontal Footcandles | | | | 30° Aiming Angle Horizontal Footcandles | | | | | 30° Aiming Angle Vertical Footcandles | | | | | 60° Aiming Angle Vertical Footcandles | | | | |
|-------------------|----------------------------------------|-----|-----|-----|-----------------------------------------|-----|-----|-----|-----|---------------------------------------|-----|-----|-----|-----|---------------------------------------|-----|-----|-----|-----|
| | D | FC | L | W | D | FC | L | W | CB | D | FC | L | W | CB | D | FC | L | W | CB |
| SPOT | 5.0' | 540 | 1.2 | 1.2 | 5.0' | 348 | 1.6 | 1.4 | 3.0 | 3.0' | 200 | 2.8 | 1.4 | 5.0 | 3.0' | 726 | 1.3 | 1.1 | 2.0 |
| | 7.5' | 241 | 1.8 | 1.8 | 7.5' | 155 | 2.5 | 2.2 | 4.0 | 4.0' | 121 | 3.5 | 1.8 | 6.0 | 4.0' | 518 | 1.5 | 1.2 | 2.0 |
| | 10.0' | 136 | 2.6 | 2.6 | 10.0' | 85 | 3.4 | 3.0 | 6.0 | 5.0' | 77 | 4.3 | 2.5 | 8.0 | 5.0' | 334 | 1.8 | 1.3 | 3.0 |
| | 12.5' | 87 | 3.2 | 3.2 | 12.5' | 57 | 4.2 | 3.6 | 7.0 | 6.0' | 54 | 5.2 | 2.9 | 9.0 | 6.0' | 230 | 2.2 | 1.6 | 3.0 |
| VERY NARROW FLOOD | 5.0' | 473 | 1.4 | 1.4 | 5.0' | 305 | 1.9 | 1.5 | 3.0 | 3.0' | 176 | 3.4 | 1.5 | 5.0 | 3.0' | 651 | 1.6 | 1.2 | 2.0 |
| | 7.5' | 211 | 2.1 | 2.1 | 7.5' | 136 | 2.9 | 2.5 | 4.0 | 4.0' | 108 | 4.1 | 2.0 | 6.0 | 4.0' | 462 | 1.6 | 1.3 | 2.0 |
| | 10.0' | 119 | 2.9 | 2.9 | 10.0' | 75 | 3.8 | 3.3 | 6.0 | 5.0' | 67 | 5.3 | 2.8 | 8.0 | 5.0' | 293 | 2.0 | 1.5 | 3.0 |
| | 12.5' | 76 | 3.5 | 3.5 | 12.5' | 50 | 4.7 | 3.9 | 7.0 | 6.0' | 49 | 6.3 | 3.2 | 9.0 | 6.0' | 206 | 2.4 | 1.8 | 3.0 |
| NARROW FLOOD | 5.0' | 358 | 1.9 | 1.9 | 5.0' | 257 | 2.4 | 2.1 | 3.0 | 3.0' | 181 | 3.2 | 1.8 | 4.0 | 3.0' | 620 | 1.9 | 1.2 | 2.0 |
| | 7.5' | 159 | 2.9 | 2.9 | 7.5' | 115 | 3.5 | 3.2 | 4.0 | 4.0' | 96 | 4.4 | 2.8 | 6.0 | 4.0' | 426 | 1.9 | 1.5 | 2.0 |
| | 10.0' | 90 | 3.8 | 3.8 | 10.0' | 63 | 4.8 | 4.2 | 5.0 | 5.0' | 63 | 5.3 | 3.3 | 7.0 | 5.0' | 249 | 2.5 | 2.2 | 3.0 |
| | 12.5' | 58 | 4.8 | 4.8 | 12.5' | 40 | 6.1 | 5.4 | 7.0 | 6.0' | 43 | 6.7 | 4.0 | 8.0 | 6.0' | 182 | 2.9 | 2.6 | 3.0 |
| FLOOD | 5.0' | 190 | 2.9 | 2.9 | 5.0' | 130 | 3.5 | 3.1 | 2.0 | 3.0' | 113 | 3.4 | 2.7 | 3.0 | 3.0' | 340 | 2.3 | 1.8 | 1.0 |
| | 7.5' | 85 | 4.3 | 4.3 | 7.5' | 58 | 5.2 | 4.8 | 3.0 | 4.0' | 64 | 4.6 | 3.5 | 4.0 | 4.0' | 208 | 2.8 | 2.6 | 2.0 |
| | 10.0' | 48 | 5.7 | 5.7 | 10.0' | 34 | 6.8 | 6.4 | 5.0 | 5.0' | 41 | 5.8 | 4.4 | 5.0 | 5.0' | 133 | 3.5 | 3.1 | 2.0 |
| | 12.5' | 31 | 7.2 | 7.2 | 12.5' | 22 | 8.5 | 8.0 | 6.0 | 6.0' | 29 | 7.0 | 5.2 | 7.0 | 6.0' | 93 | 4.1 | 3.8 | 3.0 |
| WIDE FLOOD | 5.0' | 125 | 3.3 | 3.3 | 5.0' | 92 | 3.9 | 3.5 | 2.0 | 3.0' | 92 | 3.2 | 2.7 | 3.0 | 3.0' | 254 | 2.3 | 2.0 | 1.0 |
| | 7.5' | 56 | 5.0 | 5.0 | 7.5' | 41 | 5.6 | 5.4 | 3.0 | 4.0' | 52 | 4.3 | 3.6 | 4.0 | 4.0' | 138 | 3.2 | 3.0 | 2.0 |
| | 10.0' | 32 | 6.7 | 6.7 | 10.0' | 23 | 7.6 | 7.3 | 4.0 | 5.0' | 34 | 5.3 | 4.6 | 5.0 | 5.0' | 93 | 3.9 | 3.5 | 2.0 |
| | 12.5' | 20 | 8.5 | 8.5 | 12.5' | 15 | 9.6 | 9.2 | 5.0 | 6.0' | 23 | 6.5 | 5.5 | 6.0 | 6.0' | 64 | 4.7 | 4.5 | 2.0 |

CYLINDRIX III MINI

VERTICAL TRACK ACCENT LED

C3MV
LED



TYPE:



FIXTURE DATA:

Complete photometric data (ies format) available upon request.

CCT Correction Factors: 2700-83 = 0.96; 3500-83 = 1.02; 4000-83 = 1.04; 2200-90+ = 0.71; 2700-90+ = 0.80; 3000-90+ = 0.83; 3500-90+ = 0.87; Crisp = 0.65

18W LED (3000K-83)

VERY NARROW SPOT (VNSP)
DISTRIBUTION
LTL #1170140

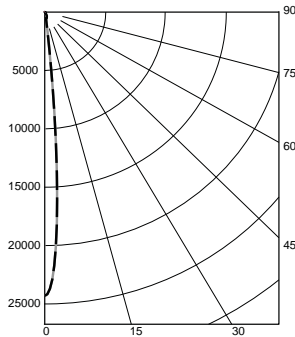

| Candelas at Nadir | Deg | Candela |
|-------------------|-----|---------|
| | 0 | 24308 |
| | 5 | 8980 |
| | 15 | 527 |
| | 25 | 394 |
| | 35 | 131 |
| | 45 | 57 |

APPLICATION DATA:

Notes and Definitions:

Beam spread is to 50% center beam candlepower (CBCP).
 D=Distance to floor or wall.
 FC=Footcandles on floor or wall at center beam aiming location.
 L=Effective Visual Beam length in feet (50% of maximum footcandle level).
 W=Effective Visual Beam width in feet (50% of maximum footcandle level).
 CB=Distance across or down to center beam location.

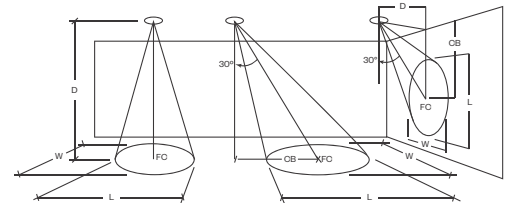

0° Aiming Angle
Horizontal
Footcandles



30° Aiming Angle
Horizontal
Footcandles



30° Aiming Angle
Vertical
Footcandles



60° Aiming Angle
Vertical
Footcandles

| VERY NARROW SPOT | 0° Aiming Angle Horizontal Footcandles | | | | 30° Aiming Angle Horizontal Footcandles | | | | | 30° Aiming Angle Vertical Footcandles | | | | | 60° Aiming Angle Vertical Footcandles | | | | |
|------------------|----------------------------------------|-----|-----|-----|-----------------------------------------|-----|-----|-----|-----|---------------------------------------|-----|-----|-----|------|---------------------------------------|-----|-----|-----|-----|
| | D | FC | L | W | D | FC | L | W | CB | D | FC | L | W | CB | D | FC | L | W | CB |
| | 5.0' | 967 | 1.0 | 1.0 | 5.0' | 624 | 1.0 | 1.0 | 3.0 | 3.0' | 360 | 1.5 | 1.0 | 5.0 | 3.0' | 983 | 1.0 | 1.0 | 2.0 |
| | 7.5' | 431 | 1.1 | 1.1 | 7.5' | 251 | 1.8 | 1.1 | 4.0 | 4.0' | 185 | 2.4 | 1.1 | 7.0 | 4.0' | 729 | 1.1 | 1.0 | 2.0 |
| | 10.0' | 243 | 1.3 | 1.3 | 10.0' | 153 | 2.1 | 1.6 | 6.0 | 5.0' | 129 | 2.7 | 1.2 | 8.0 | 5.0' | 600 | 1.1 | 1.0 | 3.0 |
| | 12.5' | 156 | 1.8 | 1.8 | 12.5' | 102 | 2.4 | 2.2 | 7.0 | 6.0' | 90 | 3.3 | 1.6 | 10.0 | 6.0' | 325 | 1.9 | 1.0 | 3.0 |

CYLINDRIX III MINI

VERTICAL TRACK ACCENT LED

C3MV
LED



TYPE:



DIMMING COMPATIBILITY:

Amerlux® fixtures are compatible with all major dimming protocols prevalent in the United States. Please see below for general compatibilities and wiring diagrams. Amerlux recommends testing your unique dimming configuration as the exact full configuration (Dimmer, Fixture Quantity, Voltage, etc) may affect dimming performance.

TRIAC (Forward Phase) DIMMING (standard)

Utilizes "Standard" incandescent dimmers that are in wide use in installations across the US. Best for retrofit applications where Triac dimmers are installed.

Notes:

- 120V & 277V
- Dims down to less than 5% light output (most cases)
- Consult Dimming manufacturer for installation instructions - **DO NOT SHARE NEUTRALS!**
- Must meet dimmer Minimum Load Requirements per dimming manufacturer

Wiring Diagram

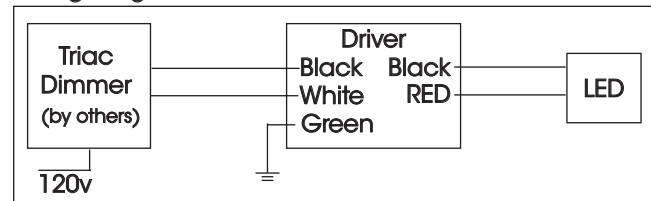

Compatible Dimmers

Wall Box (Incandescent Style, Wattage as required)

Lutron "Diva"
Lutron "Nova-T"
Lutron "Maestro"

Lutron "Vareo"
Lutron "Skylark"

Central System

ETC "SR" Rack w/D20 Module
Lutron "GP" Panel

ETC "DRD" Rack w/D20 Module
Lutron Grafix Eye QS

ELV - Electronic Low Voltage (Reverse Phase) DIMMING (standard)

Utilizes specialized "ELV" dimmers. Best for New Construction applications

Notes:

- 120V & 277V
- Dims down to less than 5% light output (most cases)
- Consult Dimming manufacturer for installation instructions - **DO NOT SHARE NEUTRALS!**
- Must meet dimmer Minimum Load Requirements

Wiring Diagram

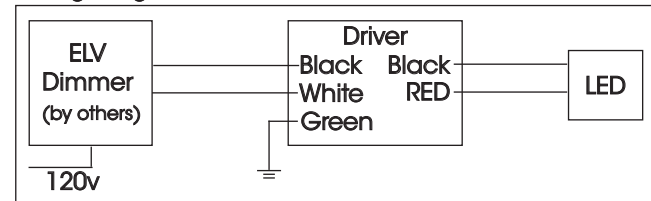

Compatible Dimmers

Wall Box (ELV Style)

Lutron "Diva"
Lutron "Nova-T"
Lutron "Maestro"
Leviton "Surslide"

Lutron "Vareo"
Lutron "Skylark"
Leviton "Vizio"

Central System

ETC "SR" Rack w/ELV10 Module
Lutron "GP" Panel with PHPM-PA Interface

ETC "DRD" Rack w/ELV10 Module
Lutron Grafix Eye QS with PHPM-PA Interface