

CYLINDRIX III MINI

HORIZONTAL TRACK ACCENT LED

APPLICATION

Accent and display lighting for retail, supermarket, commercial & hospitality environments

CONSTRUCTION:

Complete die-cast construction
No exposed wiring
Powder coat paint

ELECTRICAL:

Electronic constant current LED driver, 120v input
ELV and Triac dimming standard, 120v
See following pages for more information.

This product complies with IEEE C62.41 for surge endurance up to 2.5KV. Amerlux® recommends using additional surge protection with this unit (supplied by others), surge damage is not covered by warranty.

OPTICS:

0-180° tilt, 180° rotation
Available in a variety of beam spreads
LED:
Color Temp Options: 2200K, 2700K, 3000K, 3500K, 4000K
CRI: 83 typ. (2700K, 3000K, 3500K, 4000K)
90+ typ. (2200K, 2700K, 3000K, 3500K)
Crisp White LED available
R9 Values: 11 (83CRI), 55 (90+CRI)
Binning: 3 MacAdam
Lumen Maintenance: >70% of initial lumens @ 50,000 hrs
Lumen Output (21w, 3000K): 1850 lm (89.6 lpw)
CBCP (3000K): SP (21w) 13,578
VNSP (18w only) 24,308

MOUNTING:

Single circuit track
Note: Ceiling mounted track only

LABELING:



Dry location

C3MH
LED



PROJECT:

TYPE:

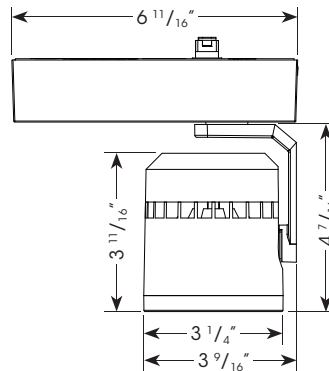
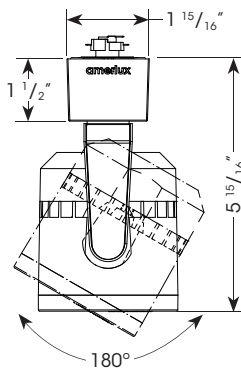

ELECTRICAL

Electronic driver

	15w		18w		21w	
	System Watts	Amps	System Watts	Amps	System Watts	Amps
120v	15	0.13	18	0.15	21	0.18

ORDERING INFORMATION:

Model	Wattage	Lamp Type	Finish	Mounting	Voltage	Beam Spread	Color Temp (CCT-CRI)	Options/Accessories
C3MH	15 21	LED	WT - white texture BT - black texture ST - silver texture	TS1 - Global GES 1cir/H-Style, 120v TJ1 - J-Style TL1 - L-Style	120	SP - spot, 14° VNF - very narrow flood, 18° NF - narrow flood, 23° FL - flood, 34° WF - wide flood, 44°	27 - 2700-83 30 - 3000-83 35 - 3500-83 40 - 4000-83 229 - 2200-90+ 279 - 2700-90+ 309 - 3000-90+ 359 - 3500-90+ 409 - 4000-90+ 3CLA - 3K Class A CRISP - CrispWhite (not for VNSP)	SN - snoot LS - linear spread HEX - hexcel louver CB - cross blade, matte black, requires snoot SOL - solite beam softening lens
	18 (8° only)		(other RAL)			VNSP - very narrow spot, 8° (18w only)		

Example: C3MH-21-LED-WT-TS1-120-FL-30

Cat #:

Amerlux reserves the right to change details that do not affect overall function and performance.



(see website for details)

CYLINDRIX III MINI

HORIZONTAL TRACK ACCENT LED

C3MH
LED



TYPE:



FIXTURE DATA: For 15w data, multiply by 0.71; For 18W data see next page

Complete photometric data (ies format) available upon request.

CCT Correction Factors: 2700-83 = 0.96; 3500-83 = 1.02; 4000-83 = 1.04; 2200-90+ = 0.71; 2700-90+ = 0.80; 3000-90+ = 0.83; 3500-90+ = 0.87; Crisp = 0.65

21W LED (3000K-83)

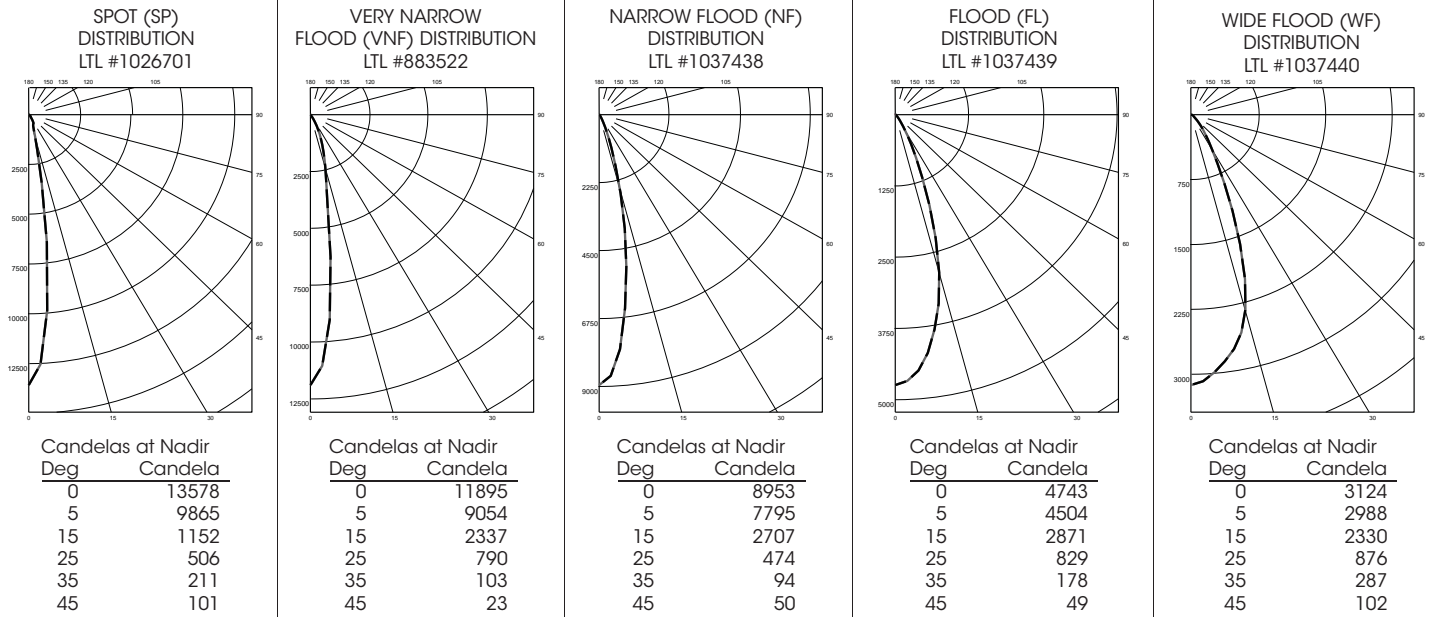

APPLICATION DATA:

Notes and Definitions:

Beam spread is to 50% center beam candlepower (CBCP).
 D=Distance to floor or wall.
 FC=Footcandles on floor or wall at center beam aiming location.
 L=Effective Visual Beam length in feet (50% of maximum footcandle level).
 W=Effective Visual Beam width in feet (50% of maximum footcandle level).
 CB=Distance across or down to center beam location.

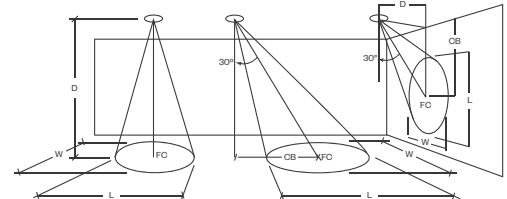

	0° Aiming Angle Horizontal Footcandles				30° Aiming Angle Horizontal Footcandles					30° Aiming Angle Vertical Footcandles					60° Aiming Angle Vertical Footcandles				
	D	FC	L	W	D	FC	L	W	CB	D	FC	L	W	CB	D	FC	L	W	CB
SPOT	5.0'	540	1.2	1.2	5.0'	348	1.6	1.4	3.0	3.0'	200	2.8	1.4	5.0	3.0'	726	1.3	1.1	2.0
	7.5'	241	1.8	1.8	7.5'	155	2.5	2.2	4.0	4.0'	121	3.5	1.8	6.0	4.0'	518	1.5	1.2	2.0
	10.0'	136	2.6	2.6	10.0'	85	3.4	3.0	6.0	5.0'	77	4.3	2.5	8.0	5.0'	334	1.8	1.3	3.0
	12.5'	87	3.2	3.2	12.5'	57	4.2	3.6	7.0	6.0'	54	5.2	2.9	9.0	6.0'	230	2.2	1.6	3.0
VERY NARROW FLOOD	5.0'	473	1.4	1.4	5.0'	305	1.9	1.5	3.0	3.0'	176	3.4	1.5	5.0	3.0'	651	1.6	1.2	2.0
	7.5'	211	2.1	2.1	7.5'	136	2.9	2.5	4.0	4.0'	108	4.1	2.0	6.0	4.0'	462	1.6	1.3	2.0
	10.0'	119	2.9	2.9	10.0'	75	3.8	3.3	6.0	5.0'	67	5.3	2.8	8.0	5.0'	293	2.0	1.5	3.0
	12.5'	76	3.5	3.5	12.5'	50	4.7	3.9	7.0	6.0'	49	6.3	3.2	9.0	6.0'	206	2.4	1.8	3.0
NARROW FLOOD	5.0'	358	1.9	1.9	5.0'	257	2.4	2.1	3.0	3.0'	181	3.2	1.8	4.0	3.0'	620	1.9	1.2	2.0
	7.5'	159	2.9	2.9	7.5'	115	3.5	3.2	4.0	4.0'	96	4.4	2.8	6.0	4.0'	426	1.9	1.5	2.0
	10.0'	90	3.8	3.8	10.0'	63	4.8	4.2	5.0	5.0'	63	5.3	3.3	7.0	5.0'	249	2.5	2.2	3.0
	12.5'	58	4.8	4.8	12.5'	40	6.1	5.4	7.0	6.0'	43	6.7	4.0	8.0	6.0'	182	2.9	2.6	3.0
FLOOD	5.0'	190	2.9	2.9	5.0'	130	3.5	3.1	2.0	3.0'	113	3.4	2.7	3.0	3.0'	340	2.3	1.8	1.0
	7.5'	85	4.3	4.3	7.5'	58	5.2	4.8	3.0	4.0'	64	4.6	3.5	4.0	4.0'	208	2.8	2.6	2.0
	10.0'	48	5.7	5.7	10.0'	34	6.8	6.4	5.0	5.0'	41	5.8	4.4	5.0	5.0'	133	3.5	3.1	2.0
	12.5'	31	7.2	7.2	12.5'	22	8.5	8.0	6.0	6.0'	29	7.0	5.2	7.0	6.0'	93	4.1	3.8	3.0
WIDE FLOOD	5.0'	125	3.3	3.3	5.0'	92	3.9	3.5	2.0	3.0'	92	3.2	2.7	3.0	3.0'	254	2.3	2.0	1.0
	7.5'	56	5.0	5.0	7.5'	41	5.6	5.4	3.0	4.0'	52	4.3	3.6	4.0	4.0'	138	3.2	3.0	2.0
	10.0'	32	6.7	6.7	10.0'	23	7.6	7.3	4.0	5.0'	34	5.3	4.6	5.0	5.0'	93	3.9	3.5	2.0
	12.5'	20	8.5	8.5	12.5'	15	9.6	9.2	5.0	6.0'	23	6.5	5.5	6.0	6.0'	64	4.7	4.5	2.0

CYLINDRIX III MINI

HORIZONTAL TRACK ACCENT LED

C3MH
LED



TYPE:



FIXTURE DATA:

Complete photometric data (ies format) available upon request.

CCT Correction Factors: 2700-83 = 0.96; 3500-83 = 1.02; 4000-83 = 1.04; 2200-90+ = 0.71; 2700-90+ = 0.80; 3000-90+ = 0.83; 3500-90+ = 0.87; Crisp = 0.65

18W LED (3000K-83)

VERY NARROW SPOT (VNSP)
DISTRIBUTION
LTL #1170140

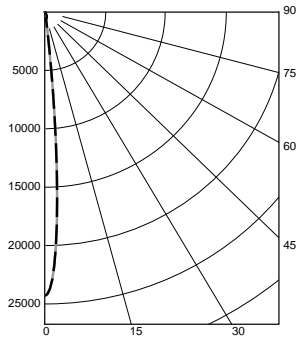

Candelas at Nadir	Deg	Candela
	0	24308
	5	8980
	15	527
	25	394
	35	131
	45	57

APPLICATION DATA:

Notes and Definitions:

Beam spread is to 50% center beam candlepower (CBCP).
 D=Distance to floor or wall.
 FC=Footcandles on floor or wall at center beam aiming location.
 L=Effective Visual Beam length in feet (50% of maximum footcandle level).
 W=Effective Visual Beam width in feet (50% of maximum footcandle level).
 CB=Distance across or down to center beam location.

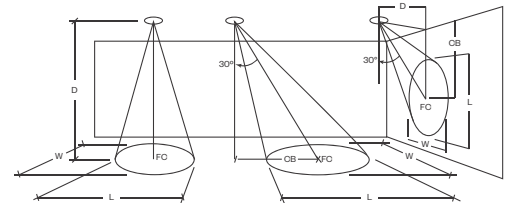

0° Aiming Angle
Horizontal
Footcandles



30° Aiming Angle
Horizontal
Footcandles



30° Aiming Angle
Vertical
Footcandles



60° Aiming Angle
Vertical
Footcandles

VERY NARROW SPOT	0° Aiming Angle Horizontal Footcandles				30° Aiming Angle Horizontal Footcandles					30° Aiming Angle Vertical Footcandles					60° Aiming Angle Vertical Footcandles				
	D	FC	L	W	D	FC	L	W	CB	D	FC	L	W	CB	D	FC	L	W	CB
	5.0'	967	1.0	1.0	5.0'	624	1.0	1.0	3.0	3.0'	360	1.5	1.0	5.0	3.0'	983	1.0	1.0	2.0
	7.5'	431	1.1	1.1	7.5'	251	1.8	1.1	4.0	4.0'	185	2.4	1.1	7.0	4.0'	729	1.1	1.0	2.0
	10.0'	243	1.3	1.3	10.0'	153	2.1	1.6	6.0	5.0'	129	2.7	1.2	8.0	5.0'	600	1.1	1.0	3.0
	12.5'	156	1.8	1.8	12.5'	102	2.4	2.2	7.0	6.0'	90	3.3	1.6	10.0	6.0'	325	1.9	1.0	3.0

CYLINDRIX III MINI

HORIZONTAL TRACK ACCENT LED

C3MH
LED



TYPE:



DIMMING COMPATIBILITY:

Amerlux® fixtures are compatible with all major dimming protocols prevalent in the United States. Please see below for general compatibilities and wiring diagrams. Amerlux recommends testing your unique dimming configuration as the exact full configuration (Dimmer, Fixture Quantity, Voltage, etc) may affect dimming performance.

TRIAC (Forward Phase) DIMMING (standard)

Utilizes "Standard" incandescent dimmers that are in wide use in installations across the US. Best for retrofit applications where Triac dimmers are installed.

Notes:

- 120v
- Dims down to less than 5% light output (most cases)
- Consult Dimming manufacturer for installation instructions - DO NOT SHARE NEUTRALS!
- Must meet dimmer Minimum Load Requirements per dimming manufacturer

Wiring Diagram

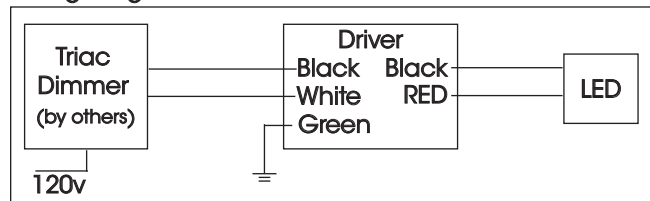

Compatible Dimmers

Wall Box (Incandescent Style, Wattage as required)

Lutron "Diva"
Lutron "Nova-T"
Lutron "Maestro"

Lutron "Vareo"
Lutron "Skylark"

Central System

ETC "SR" Rack w/D20
Module
Lutron "GP" Panel

ETC "DRD" Rack w/D20
Module
Lutron Grafix Eye QS

ELV - Electronic Low Voltage (Reverse Phase) DIMMING (standard)

Utilizes specialized "ELV" dimmers. Best for New Construction applications

Notes:

- 120v
- Dims down to less than 5% light output (most cases)
- Consult Dimming manufacturer for installation instructions - DO NOT SHARE NEUTRALS!
- Must meet dimmer Minimum Load Requirements

Wiring Diagram

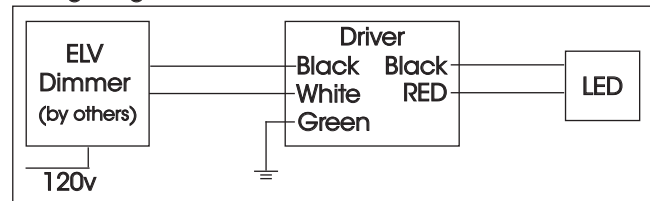

Compatible Dimmers

Wall Box (ELV Style)

Lutron "Diva"
Lutron "Nova-T"
Lutron "Maestro"
Leviton "Surslide"

Lutron "Vareo"
Lutron "Skylark"
Leviton "Vizio"

Central System

ETC "SR" Rack w/ELV10
Module
Lutron "GP" Panel with
PHPM-PA Interface

ETC "DRD" Rack w/ELV10
Module
Lutron Grafix Eye QS with
PHPM-PA Interface