

# EVOKE® 2.9" HP

## 2.9" ROUND ADJUSTABLE LED

E2.9RA-HP-A15  
LED



### APPLICATION:

Commercial and retail accent lighting

### HOUSING CONSTRUCTION:

20 ga. steel painted matte black  
Formed aperture plate with 5/8" lip (GB-standard)  
Integral adjustable locking mounting bars  
Thermally protected

### REFLECTOR TRIM CONSTRUCTION:

Spun aluminum self-flanged reflector  
Variety of anodized aperture finishes in both white and clear flange

### OPTICS:

Cam adjustment mechanism provides lockable 0-40° tilt;  
360°+ rotation  
Available in a variety of beam spreads  
LED:

Color Temp Options: 2200K, 2700K, 3000K, 3500K, 4000K  
CRI: 83 typ. (2700K, 3000K, 3500K, 4000K)  
90+ typ. (2200K, 2700K, 3000K)  
Amerlux Crisp White technology available (18w max)  
R9 Value: 11 (83CRI), 55 (90+CRI)  
Binning: 3 MacAdam (SDCM)  
Life: 50,000 hrs  
Lumen Maintenance: >70% of initial lumens @ 50,000 hrs  
Lumen Output (20w, 20° tilt, 3000K): up to 1086 lm; 55.8 lm/w  
CBCP (20w, 20° tilt, 3000K): up to 6461 max.

### ELECTRICAL:

Electronic constant current LED driver, 120v or 277v input  
(voltage specific TP on 18w & 20w)  
ELV and Triac dimming standard, 120v or 277v.  
0-10v, Lutron & DALI systems available. See following pages  
for more information.

**This product complies with IEEE C62.41 for surge endurance  
up to 2.5KV. Amerlux® recommends using additional surge  
protection with this unit (supplied by others), surge damage  
is not covered by warranty.**

### MOUNTING:

Specify ceiling mounting:  
GRID: 1" deep aperture collar  
GB (Gyp. Board): 5/8" deep aperture collar  
Extra thick ceiling ring available for ceilings over 1" thick,  
consult factory  
Note: Tilt adjustment reduced to 30° in ceilings 1 1/4" thick

### LABELING:



Damp location  
IC/AT rated (11w only)

PROJECT:

TYPE:

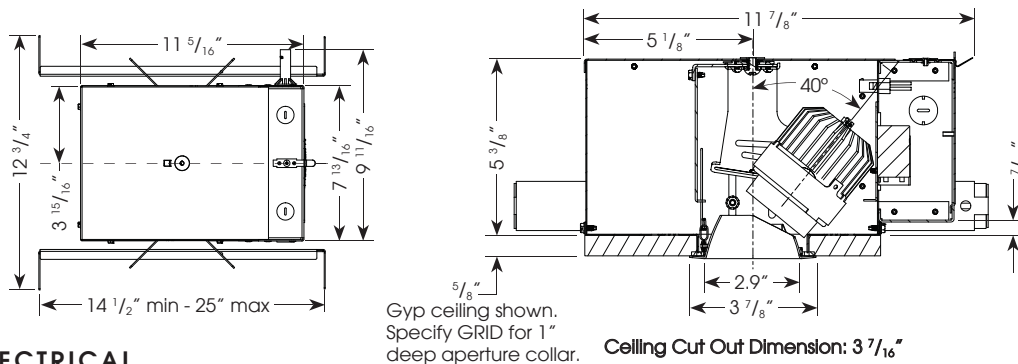

### ELECTRICAL

Electronic driver

	11w		18w*		20w*	
	System Watts	Amps	System Watts	Amps	System Watts	Amps
120v	11	0.09	18	0.15	20	0.17
277v	11	0.04	18	0.06	20	0.07

\* 2w thermal protector included on 18w & 20w

### ORDERING INFORMATION:

Housing Model	Wattage	Lamp Type	Voltage	Beam Spread	Ceiling Mounting	Color Temp (CCT(K)-CRI)	Options	Reflector Model	Aperture Finish
E2.9RA-HP-A15	11	LED	120	SP - spot, 15°	GB - 5/8"	27 - 2700-83	HILUME - Lutron Hi-lume® A-series dimming (Ecosystem or 3 wire)	E2.9RA-HP-A15	<u>Reflector with White Painted Flange</u> SDW - semi-diffuse CLW - specular clear MWW - matte white
	18		277	NF - narrow flood, 20°	deep collar	30 - 3000-83			
20			MFL - medium flood, 24°	deep collar	35 - 3500-83				
				FL - flood, 28°	(other, consult factory)	229 - 2200-90+			<u>Reflector with Clear Flange</u> (flange finish matches cone finish) SDC - semi-diffuse CLC - specular clear
				WF - wide flood, 45°		279 - 2700-90+			
				VWF - very wide flood, 60°		309 - 3000-90+			
				LS - linear spread, 60° x 10°			CRISP - CrispWhite (18w max)		

Complete Unit Specification: E2.9RA-HP-A15-20-LED-120-SP-GB-30/E2.9RA-HP-A15-SDW

Housing Only: E2.9RA-HP-A15-20-LED-120-SP-GB-30

Reflector Only: E2.9RA-HP-A15-SDW

Cat #:

Amerlux® reserves the right to change details that do not affect overall function and performance.

Amerlux®, LLC • 178 Bauer Drive, Oakland, NJ 07436 • P: 973.882.5010 F: 973-882.2605 • www.amerlux.com



# EVOKE® 2.9" HP

2.9" ROUND ADJUSTABLE LED

E2.9RA-HP-A15  
LED



TYPE:



**FIXTURE DATA:** For 11w data, multiply by 0.55; For 18w data, multiply by 0.9

Complete photometric data (ies format) available upon request.

## 20W LED

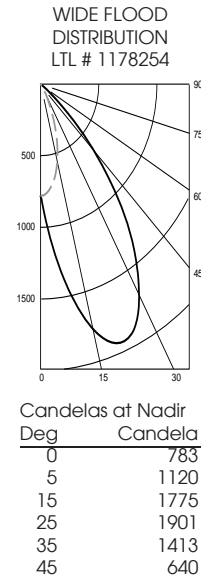
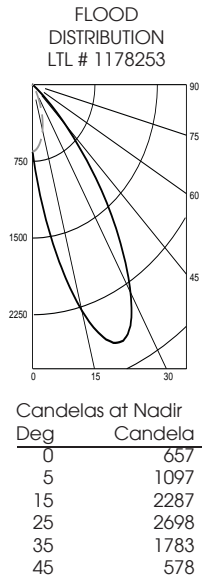
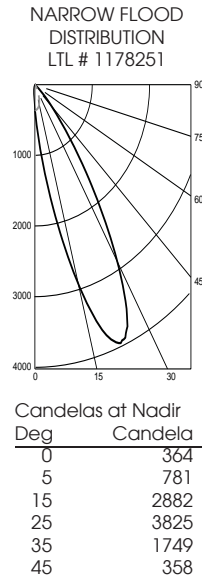
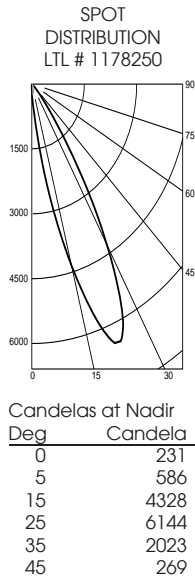

## APPLICATION DATA:

### Notes and Definitions:

Beam spread is to 50% center beam candlepower (CBCP).  
 D=Distance to floor or wall.  
 FC=Footcandles on floor or wall at center beam aiming location.  
 L=Effective Visual Beam length in feet (50% of maximum footcandle level).  
 W=Effective Visual Beam width in feet (50% of maximum footcandle level).  
 CB=Distance across or down to center beam location.

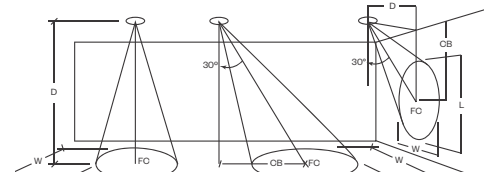

	20° Aiming Angle Horizontal Footcandles					20° Aiming Angle Vertical Footcandles				
	D	FC	L	W	CB	D	FC	L	W	CB
SPOT	5.0'	228	1.9	2.2	2.0	3.0'	52	4.4	3.0	5.5
	7.5'	98	2.8	3.3	3.0	4.0'	30	5.9	3.8	7.5
	10.0'	54	3.8	4.5	4.0	5.0'	20	7.4	4.7	9.5
	12.5'	35	4.8	5.6	5.0	6.0'	14	8.8	5.5	10.5
NARROW FLOOD	5.0'	126	2.3	3.0	2.0	3.0'	37	4.6	3.4	5.5
	7.5'	56	3.4	4.3	3.0	4.0'	21	6.1	4.6	6.5
	10.0'	32	4.5	5.7	4.0	5.0'	14	7.6	5.6	8.5
	12.5'	20	5.6	7.2	5.0	6.0'	10	9.2	6.7	10.5
FLOOD	5.0'	87	3.0	3.1	2.0	3.0'	33	3.3	4.4	4.5
	7.5'	39	4.5	4.7	3.0	4.0'	20	5.6	4.3	5.5
	10.0'	22	5.9	6.2	4.0	5.0'	13	7.1	5.3	7.5
	12.5'	14	7.4	7.7	4.0	6.0'	9	8.5	6.3	8.5
WIDE FLOOD	5.0'	62	3.6	3.6	2.0	3.0'	26	4.3	3.5	4.5
	7.5'	29	5.2	5.2	2.0	4.0'	16	5.5	4.5	5.5
	10.0'	16	6.8	7.0	3.0	5.0'	11	6.8	5.5	6.5
	12.5'	11	8.6	8.9	4.0	6.0'	8	8.2	6.6	7.5

# EVOKE® 2.9" HP

2.9" ROUND ADJUSTABLE LED

E2.9RA-HP-A15  
LED



TYPE:



## DIMMING COMPATIBILITY:

Amerlux® fixtures are compatible with all major dimming protocols prevalent in the United States. Please see below for general compatibilities and wiring diagrams. Amerlux® recommends testing your unique dimming configuration as the exact full configuration (Dimmer, Fixture Quantity, Voltage, etc) may affect dimming performance.

### TRIAC (Forward Phase) DIMMING (standard)

Utilizes "Standard" incandescent dimmers that are in wide use in installations across the US. Best for retrofit applications where Triac dimmers are installed.

#### Notes:

- 120v or 277v
- Dims down to less than 5% light output (most cases)
- Consult Dimming manufacturer for installation instructions - DO NOT SHARE NEUTRALS!
- Must meet dimmer Minimum Load Requirements per dimming manufacturer

#### Wiring Diagram

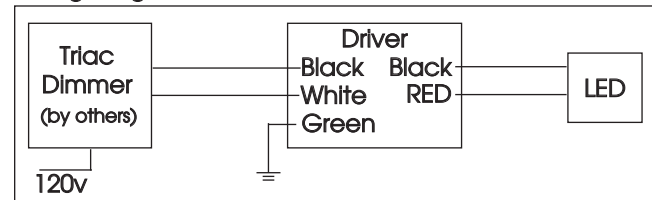

#### Compatible Dimmers

##### Wall Box (Incandescent Style, Wattage as required)

Lutron "Diva"	Lutron "Vareo"
Lutron "Nova-T"	Lutron "Skylark"
Lutron "Maestro"	

##### Central System

ETC "SR" Rack w/D20 Module	ETC "DRD" Rack w/D20 Module
Lutron "GP" Panel	Lutron Grafix Eye QS

### ELV - Electronic Low Voltage (Reverse Phase) DIMMING (standard)

Utilizes specialized "ELV" dimmers. Best for New Construction applications

#### Notes:

- 120v or 277v
- Dims down to less than 5% light output (most cases)
- Consult Dimming manufacturer for installation instructions - DO NOT SHARE NEUTRALS!
- Must meet dimmer Minimum Load Requirements

#### Wiring Diagram

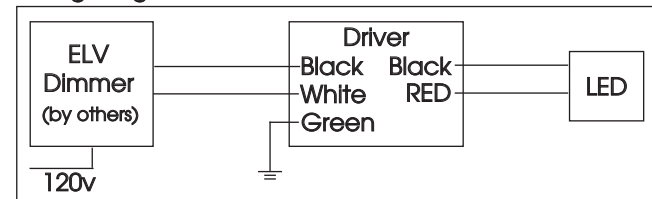

#### Compatible Dimmers

##### Wall Box (ELV Style)

Lutron "Diva"	Lutron "Vareo"
Lutron "Nova-T"	Lutron "Skylark"
Lutron "Maestro"	
Leviton "Surslide"	Leviton "Vizio"

##### Central System

ETC "SR" Rack w/ELV10 Module	ETC "DRD" Rack w/ELV10 Module
Lutron "GP" Panel with PHPM-PA Interface	Lutron Grafix Eye QS with PHPM-PA Interface

### 0-10V - DIMMING (-0-10V Option)

Integrates into a variety of building management and daylighting controls

#### Notes:

- 120v - 277v
- Dims down to 1% light output
- Requires interface to turn off power to driver
- Consult Dimming manufacturer for installation instructions - DO NOT SHARE NEUTRALS!

#### Wiring Diagram

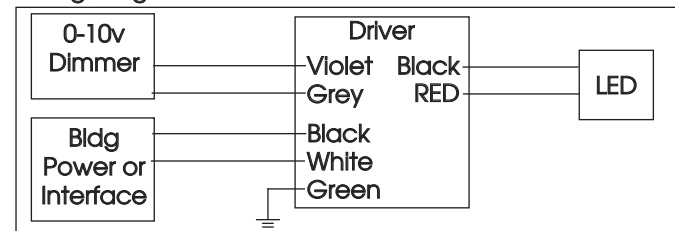

#### Compatible Dimmers

##### Wall Box

Lutron "Diva" - DVTV with PP-120H Interface	Leviton Renoir II 0-10v
---	-------------------------

##### Central System

Lutron Grafix Eye with GRX-TVI Interface
--

# EVOKE® 2.9" HP

2.9" ROUND ADJUSTABLE LED

E2.9RA-HP-A15  
LED



TYPE:



## LUTRON HI-LUME / ECO-SYSTEM (-HILUME Option)

Integrates into a variety of building management and daylighting controls

### Notes:

- 120v or 277v
- Dims down to 1% light output
- May use 3-Wire or Ecosystem Control
- Consult Dimming manufacturer for installation instructions - DO NOT SHARE NEUTRALS!

### Compatible Dimmers

#### Wall Box (3-Wire Fluorescent)

DIVA  
Maestro  
Nova T  
Vareo

#### Central System

Lutron ECO-System compatible controls  
ETC "SR" Rack w/D20F Module  
ETC "DRD" Rack w/D20F Module

### 3-Wire Wiring Diagram

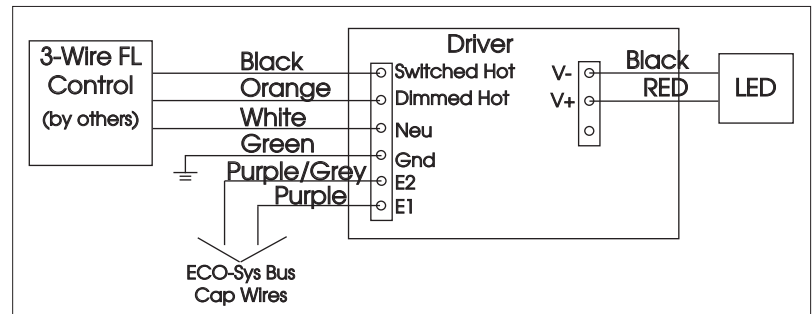

### ECO System Digital Control Wiring

