

Linea® 1.5" Mini

Direct

Linear, Remote Driver



Features

Linea drives your design scenario, seamlessly. Streamlined and flexible, these architectural LED pendants provide the freedom to create truly dynamic spaces. A synthesis of aesthetics, performance and energy efficiency, the Linea family delivers on its promises. Our tiny new Linea 1.5" pendant proves when it comes to lighting, less really is more. Linea. The power of disciplined design.

Product Overview

Type:	Cable Suspended, Remote Driver
Wattage:	5W/ft, 10W/ft (other wattages available see p2)
Lumen Output:	3,263 Lm; 78.4 Lm/W (10W, 4ft fixture)
Color Temp:	2700K, 3000K, 3500K, 4000K
CRI:	83 typ. (2700K, 3000K, 3500K, 4000K)
Dimming:	0-10V, 1% dimming (standard) Lutron Hi-lume® 3 wire, 1% dim Lutron Hi-lume® EcoSystem, 1% dim Lutron Hi-lume® 2 wire (120V only) Lutron Hi-lume® EcoSystem, 1% dim, fade to off Lutron Hi-lume® 5 Series DALI dimming, 0.1% dim

PROJECT:

TYPE:

Fixture Summary *(see following pages for more information)*

Performance Chart

Wattage per Foot	Delivered Lumens	LPW	Color Temp
5	1840	87	3500K-83
10	3263	78	3500K-83

*Data is based on 3500K-83 IES files available on website
Data is based on 4' fixture with performance lens*

Runs

Individual Runs: 2' - 8' *(whole foot standard)*

Continuous Runs: Available *(whole foot standard)*

Custom: Made to measure available (nearest 1/8" of field dimensions).

Requires approval drawings. Added cost & lead time.

Electrical Data

Wattage per foot		4'		8'	
		System Watts	Amps	System Watts	Amps
5	120V	19	0.16	37	0.31
	277V	21.3	0.08	38	0.14
10	120V	40	0.33	80	0.66
	277V	40	0.15	80	0.30

Electronic multi-volt (120V-277V), constant current LED driver

Standard Patterns

"L"	"J"	"U"	"O"	"Z"	Wall to Ceiling	Custom*
Yes	Yes	Yes	Yes	Yes	No	Yes

* Submit drawing, consult factory



Linea® 1.5" Mini Direct

Linear Mini Direct, Remote Driver



PROJECT:

TYPE:

Ordering Information

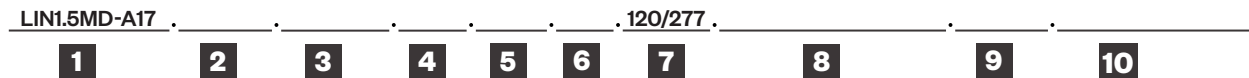

1 Model
LIN1.5MD-A17* (Mini Direct, remote driver)

2 Optics
PL - performance lens (standard)
SLDW - straight blade louver (wh) solid blades w/overlay
SLDB - straight blade louver (blk) solid blades w/overlay
SLDS - straight blade louver (slv) solid blades w/overlay
SLDPW - straight blade louver (wh) perf blades w/overlay
SLDPB - straight blade louver (blk) perf blades w/overlay
SLDPS - straight blade louver (slv) perf blades w/overlay
ASY - asymmetric lens
GRZ - grazer lens (suggest cove installation, see page 4)

3 Mounting (Mini Cable Suspension)
MASW10 - through ceiling tile or gyp board, white, 10'
MASB10 - through ceiling tile or gyp board, black, 10'
MASW10T - over ceiling tee, white, 10'
MASB10T - over ceiling tee, black, 10'
SM - surface mount

4 Wattage (per foot)
Standard:
5 - 5W/ft
10 - 10W/ft
Optional:
3 - 3W/ft (4' minimum length required)
4 - 4W/ft (4' minimum length required)
6 - 6W/ft
7 - 7W/ft
8 - 8W/ft
9 - 9W/ft

5 Color Temp
83 CRI:
27 - 2700K-83
30 - 3000K-83
35 - 3500K-83
40 - 4000K-83
92 CRI optional, consult factory

6 Finish
HW - high reflectance matte white
BT - black texture
ST - silver texture
For other RAL color, consult factory

7 Voltage
120/277

8 Length

(Length A)	(Length B)	(Length C)
Length A (used for)	Length B (used for)	Length C (used for)
- all patterns	- all patterns	- PU
- IND	- PR - 2 lengths	- PZ
- CON	of 2	
- CUS		

9 Configuration
IND¹ - individual fixture, 2' to 8' in 1' increments
CON - continuous run > than 8', specify to nearest foot
CUS - custom made to measure, +/- 1/8" of customer supplied field dimensions
Standard Patterns (see page 6 for details):
PLL - L left, (2) straights + (1) 90° corner, leg right
PLR - L right, (2) straights + (1) 90° corner, leg left
PU - U shape, (3) straight lengths + (2) 90° corners
PR - Rectangle, (4) straight lengths + (4) 90° corners
PZ - Z shape, (3) straight lengths + (2) 90° corners
Custom Patterns:
PC - please provide drawings and consult factory

10 Drivers
0-10V - 1% electronic dimming, multi-volt (120V-277V) constant current driver (standard).
HILUME-A-DH - Lutron "A" Series, 1% dim, 3-wire (Dim Hot)
HILUME-A-ECO - Lutron "A" Series, 1% dim, EcoSystem
HILUME-A-LTE - Lutron "A" Series, 1% dim, 2-wire, 120V only
HILUME-H-ECO - Lutron "H" Series, 1% dim, fade to off, EcoSystem
HILUME-5-ECO - Lutron "5" Series, EcoSystem
DALI - DALI Dimming 120V-277V, 0.1% dim

Notes:
 1 - Lengths less than 4' may have restrictions based upon wattage, lengths, drivers or other options.

* The "A" refers to the sequential revision in a year and "xx" refers to the year of update. Updates coincide with improved performance while not changing the overall fixture aesthetic and are reflected in the published performance data. Please contact your Amerlux representative for explanations of changes.

Linea® 1.5" Mini Direct

Linear Mini Direct, Remote Driver



PROJECT:

TYPE:

Specifications

Application

Open office plan, conference rooms, corridors or any indoor space where the higher light levels of a direct ambient lighting system are required. Remote location of the driver allows for a small housing with the full power of Linea 1.5 Direct.

Construction

One piece extruded aluminum housing is (1 1/2" wide X 1 7/8" high). Die-cast End Caps match fixture body finish. Painted die-formed, cold-rolled steel internal components are protected against rust and corrosion.

Optical

All lenses are snap-in, extruded acrylic, with a maximum length of 8'. Fixtures shipped with lenses installed. Amerlux's proprietary acrylic lens provides excellent transmission while effectively concealing source image. All louvers are retained with spring clips attached to louver side rails, for good fit and retention.
PL - Performance Lens provides high efficiency with greater lens surface brightness.
SLD or SLDP - Straight blade Louver Direct has 1/2" high blades 1/2" on center with overlay. Solid (SLD) or optional Perforated (SLDP) blades.
ASY - Asymmetric 20° throw lens is backed high diffusion film that eliminates striations.
GRZ - Grazer lens for highlighting wall surfaces. Suggest surface mounting in cove installation to avoid high angle brightness. No overlay is used to enhance grazing performance. (see page 4)

LED

Amerlux's boards and patented connectors with industry recognized LEDs chips enables excellent thermal management and allows Amerlux to offer a 10 year warranty. Our LED binning is within 3 MacAdam ellipse. LED boards are easily replaced in the field with just a Philips screw driver.

Color Temperature Options:

2700K, 3000K, 3500K, 4000K

CRI: 83 typical, 92 optional - consult factory

R9: 16 @ CRI 83

R9: >50 @ CRI 92

Life: 50,000+ hr., > 70% of initial lumens (L70)

Electrical

Remote Driver Wiring:

Driver is supplied installed in remote driver box, (one driver per box), with 5' of low voltage plenum rated cable. Fixture supplied with power cord ready to be connected to J-Box (by others) over cable canopy. Amerlux recommends a maximum of 30' between the fixture and the remote driver box. Consult factory with job specific electrical spec if more than 30' is required. Feeds are added as required by specified wattage and driver maximums.

See page 4 for wiring illustration

Standard Wattage: 5W/ft, 10W/ft.

Optional Wattages: 3W/ft, 4W/ft, 6W/ft, 7W/ft, 8W/ft, 9W/ft. (3W & 4W have a minimum length of 4'). For other wattages consult factory.

This product complies with IEEE C62.41 for surge endurance up to 2.5KV. Amerlux® recommends using additional surge protection with this unit (supplied by others), surge damage is not covered under warranty.

Emergency circuit via remote inverter or auxiliary emergency power supply (by others).

Drivers

0-10V - 1% electronic dimming, multi-volt (120V-277V) constant current driver (standard).

Optional drivers available. For details see pages 10-11

Finish

All painted surfaces are premium powder coated baked on for maximum durability and color stability.

For special paint colors, supply RAL and/or actual paint chip for factory consultation.

Configurations/Lengths

IND - Individuals are stand alone fixtures made of single lengths of 2' to 8' (in 1' increments). They are supplied with matching painted End Caps and the required mounting hardware. Lengths less than 4' may have restrictions based upon wattage, lengths, drivers or other options.

CON - Continuous runs are longer than 8', specified to the nearest whole foot. Continuous runs less than 16' are made of 2 lengths. Continuous runs longer than 16' start with a 8' Beginning of Row (BoR) fitted with an End Cap. The majority of the runs are made up of 8' Middle of Run (MoR) lengths. End of Run (EoR) units are made up of 2' to 8' units to the nearest whole foot or a combination of a last 4' MoR and a 5', 6' or 7' EoR. Factory installed pins and splines simplify fixture alignment. Lengths are quickly joined with "catch and latch" mechanisms or screws and sturdy brackets. Quick connectors simplify field wiring.

CUS - Custom made to measure runs are made to nearest 1/8" of customer supplied field measurements. They can be a single custom length or runs configured as described above only EoR's are 2' to 8' cut to the nearest 1/8" exact length or a combination of a last 4' MoR with an EoR cut to exact length to the nearest 1/8".

PXX - Standard patterns consist of 90° corners with standard lengths (3' to 8' in 1' increments) or custom lengths. Depending upon complexity of the pattern, drawings may be required. When ordering please give overall lengths.

See page 7 for layouts.

PC - Custom patterns use standard or custom lengths, 90° or other corner angles with some limitations. Please provide drawings and consult factory.

Mounting

LIN1.5MD-A17...MASW10 - Mini Direct pendant mount is only 1.5" wide x 1.875" high. The remote driver box is 15" long and can be located up to 30' from fixture with a 0-10V driver, 15' for Lutron drivers. 30' of low voltage plenum rated cable supplied. (see page 4)

Mini Cable Suspension:

Thinner cable, smaller gripper and cable coupler are all scaled down to match the reduced size of the LIN1.5 Mini series. 5" diameter by 0.25" canopy is used for both feed and non-feed Mini Cable Kits. Low Voltage power feeds are 18 gauge 2 conductor SJT cords supplied in same color as canopy. Amerlux supplies the required feed and non-feed suspension kits based upon length, electrical options and customer requirements. Suspension kit options include: color, length and mounting condition.

LIN1.5MD-A17...SM - Direct Surface Mounted - Housing needs to be attached to solid structure above. Mounting holes are pre-drilled at factory. Some fixture disassembly and reassembly required. Mounting hardware by others.

Certifications

Approved to UL standards for damp locations as tested by CSA
Intended for indoor use only

Warranty

Amerlux's 5 year limited warranty. Please consult Amerlux website for details.

Linea[®] 1.5" Mini Direct

Linear Mini Direct, Remote Driver



PROJECT:

TYPE:

LINEA 1.5" MINI DIRECT

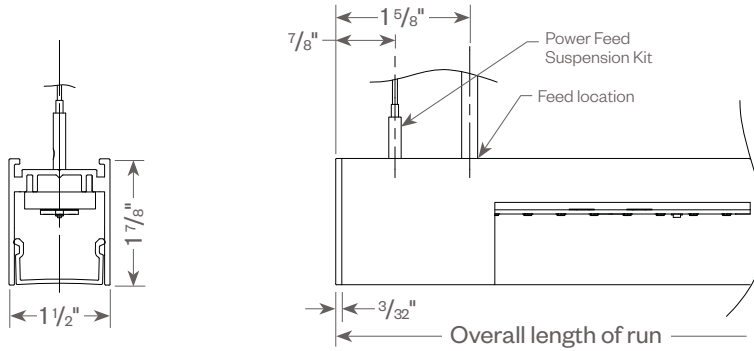

OPTIONAL LENS/LOUVERS

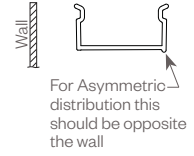

Optional Asymmetric Lens

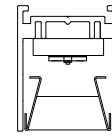

Solid Blade Louver

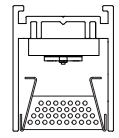

Perf Blade Louver

LINEA 1.5" MINI DIRECT GRAZER SURFACE MOUNT

The Grazer Lens for the Linea 1.5 Mini Direct was created to provide an effective and low cost wall grazing lighting tool. A cove or valance is recommended to block direct glare at mid to high angles. Surface mounting requires the housing to be attached to the structure above. Some fixture disassembly and reassembly required.

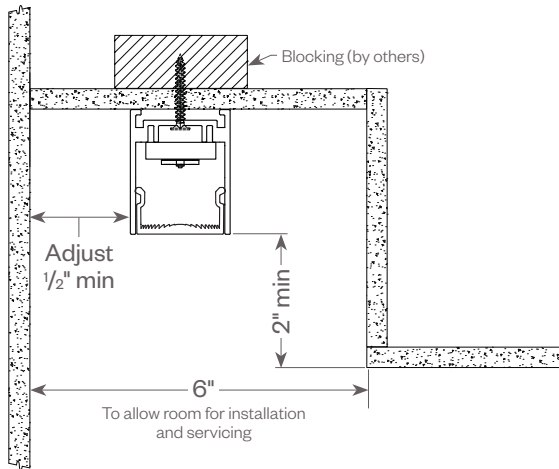

Linea[®] 1.5" Mini Direct

Linear Mini Direct, Remote Driver



PROJECT:

TYPE:

5W/FT REMOTE

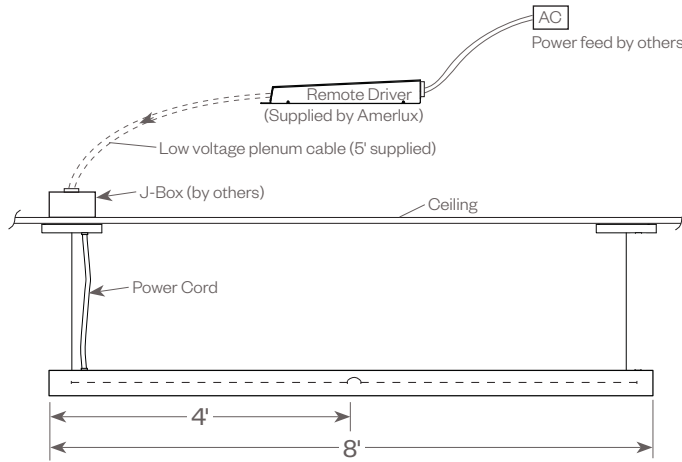

10W/FT REMOTE

Note: Driver required for every 4'. Remote drivers can be installed up to 30' max from fixture.

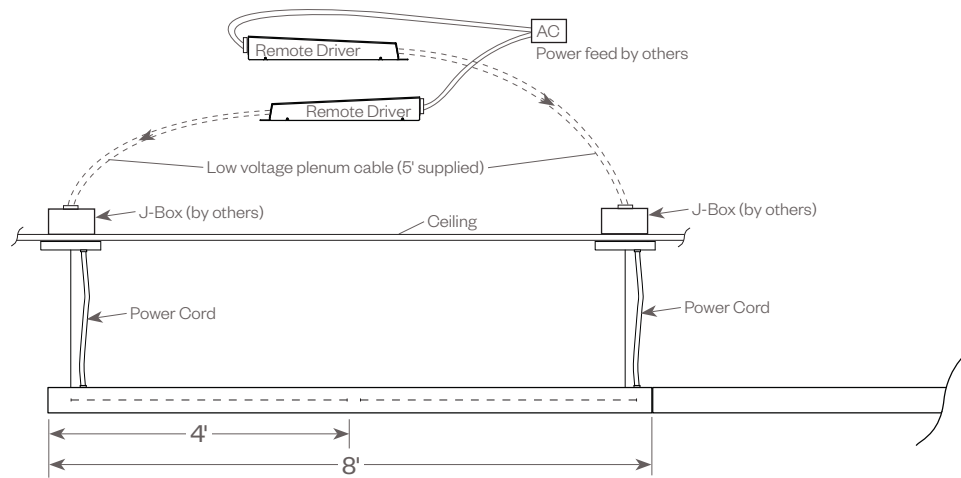

REMOTE DRIVER BOX

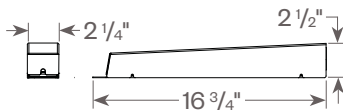

SUSPENSION DETAIL

Blocking by G.C. (for direct fastening of Griplock)

Non-Feed Canopy
ASW10:
120" Aircraft Cable
Ø5" White Canopy

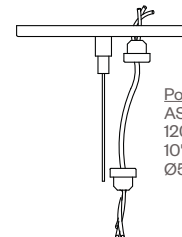
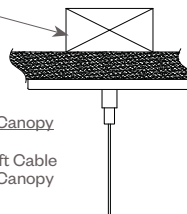

Power Feed Canopy
ASW10:
120" Aircraft Cable
10' White Cord 16/3
Ø5" White Canopy

Linea[®] 1.5" Mini Direct

Linear Mini Direct, Remote Driver



PROJECT:

TYPE:

MINI CABLE KIT SUSPENSION OPTIONS:

CEILING OR GYPSUM BOARD (MASW10, MASB10)

Cat#	Length	Cord/Canopy	Application
MASW10	10'	white/white	ceiling tile/gypsum
MASB10	10'	black/black	ceiling tile/gypsum
MASW10T	10'	white/white	ceiling tee
MASB10T	10'	black/black	ceiling tee

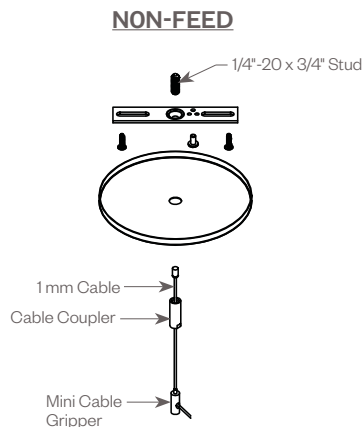
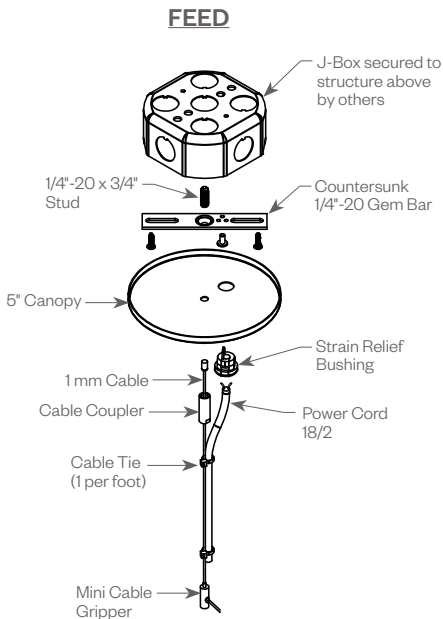

TEE GRID OR SCREW SLOT (MASW10T, MASB10T)

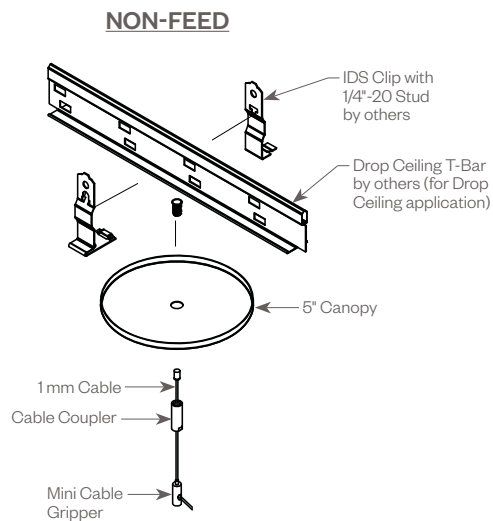
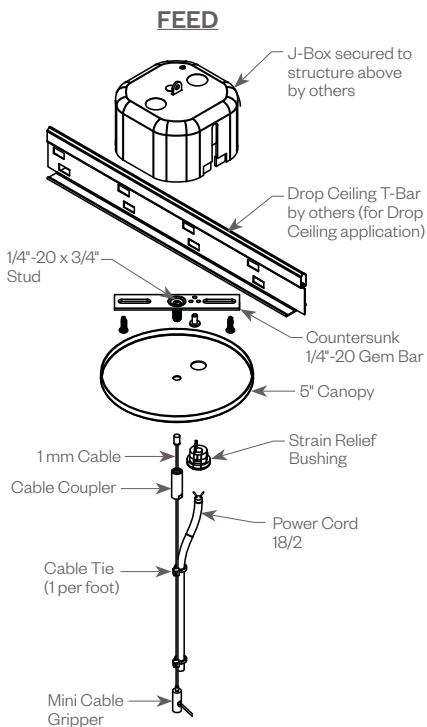

Linea[®] 1.5" Mini Direct

Linear Mini Direct, Remote Driver



PROJECT:

TYPE:

LINEA 1.5" PATTERNS:

Standard Patterns

All corners are standard 90°, standard length legs.
 Use standard lengths: 4' min to 8' in 1 foot increments.
 Continuous runs must be the same length in pairs for closed configuration.

Custom Patterns

Please provide drawings of your configuration.
 Made to Measure: +/- 1/8", consult factory.
 PC - custom pattern, please provide drawings and consult factory

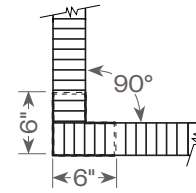

Linea 1.5 SLD
 Butt Joint-Straight
 Blade Louver

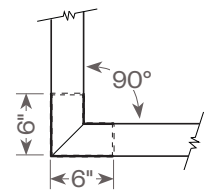

Linea 1.5 Lens
 Mitered Lens

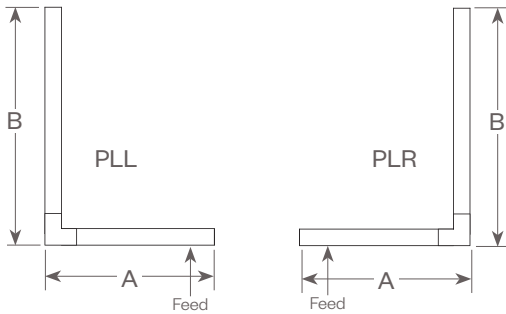

PLL - L Left, (2) straights + (1) 90° corner, leg right
PLR - L Right, (2) straights + (1) 90° corner, leg left
 Provide overall lengths: A' & B'
 Nomenclature: A-B-PLL A-B-PLR

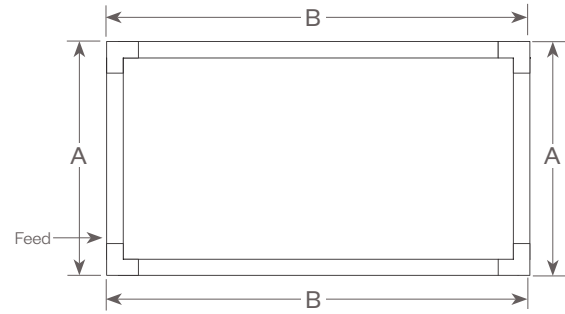

PR - Closed Rectangle, (4) straight lengths + (4) 90° corners
 Provide overall lengths: A' & B'
 Nomenclature: A-B-PR

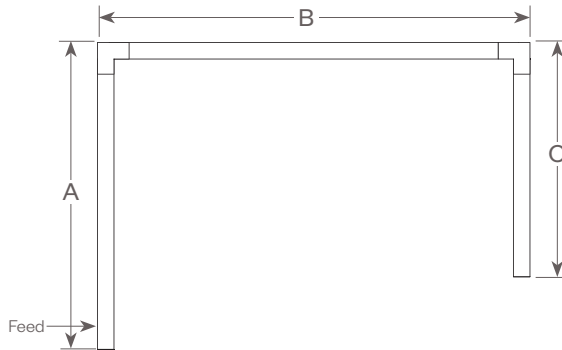

PU - Open U, (3) straight lengths + (2) 90° corners
 Provide overall lengths: A', B' & C'
 Nomenclature: A-B-C-PU

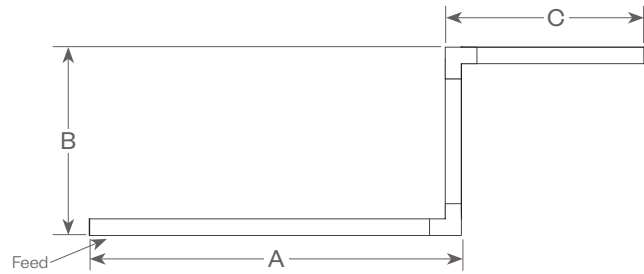

PZ - Open Z, (3) straight lengths + (2) 90° corners
 Provide overall lengths: A', B' & C'
 Nomenclature: A-B-C-PZ

Linea[®] 1.5" Mini Direct

Linear Mini Direct, Remote Driver



PROJECT:

TYPE:

FIXTURE DATA: (Complete photometric data (.ies format) available upon request)

MULTIPLYING FACTORS: (Multiplying Factor is based on 3500K-83 120V IES file on website)

Wattage:	3W	4W	5W	6W	7W	8W	9W
Factor:	0.63	0.82	1.0	1.17	1.34	1.50	1.64

CCT:	2700K-83	3000K-83	3500K-83	4000K-83
Factor:	0.87	0.93	1.0	1.08

LINEA 1.5" MINI DIRECT PERFORMANCE LENS 5W 3500K 4FT

Total Watts: 21
Total Lumens: 1,840
Source: 96 White LED's

LTL# 695285

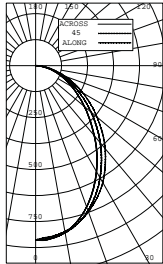

ZONAL LUMEN SUMMARY

Zone	Lumens	%Fixt
0-30	614	33.36
0-40	958	52.08
0-60	1535	83.42
0-90	1840	100.00
40-90	882	47.92
60-90	305	16.58
90-180	0	0.00
0-180	1840	100.00

Efficacy = 87.6 Lumens /Watt

COEFFICIENTS OF UTILIZATION

Effective Floor Cavity Reflectance 20%

RC	80			
RW	70	50	30	10
ROR				
0	1.19	1.19	1.19	1.19
1	1.10	1.06	1.03	0.99
2	1.02	0.95	0.89	0.8
3	0.94	0.85	0.78	0.72
4	0.88	0.77	0.69	0.64
5	0.81	0.70	0.62	0.56
6	0.75	0.63	0.55	0.49
7	0.69	0.57	0.49	0.44
8	0.65	0.52	0.44	0.39
9	0.60	0.48	0.40	0.35
10	0.56	0.44	0.36	0.31

LINEA 1.5" MINI DIRECT PERFORMANCE LENS 10W 3500K 4FT

Total Watts: 42
Total Lumens: 3,263
Source: 96 White LED's

LTL# 695286

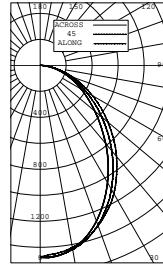

ZONAL LUMEN SUMMARY

Zone	Lumens	%Fixt
0-30	1082	33.16
0-40	1691	51.83
0-60	2716	83.25
0-90	3263	100.00
40-90	1572	48.17
60-90	547	16.75
90-180	0	0.00
0-180	3263	100.00

Efficacy = 78.4 Lumens /Watt

COEFFICIENTS OF UTILIZATION

Effective Floor Cavity Reflectance 20%

RC	80			
RW	70	50	30	10
ROR				
0	1.19	1.19	1.19	1.19
1	1.10	1.06	1.03	0.99
2	1.02	0.95	0.89	0.84
3	0.94	0.85	0.78	0.72
4	0.87	0.77	0.69	0.63
5	0.81	0.70	0.61	0.55
6	0.75	0.63	0.55	0.49
7	0.69	0.57	0.49	0.43
8	0.65	0.52	0.44	0.39
9	0.60	0.48	0.40	0.34
10	0.56	0.44	0.36	0.31

LINEA 1.5" MINI DIRECT STRAIGHT BLADE LOUVER 5W 3500K 4FT

Total Watts: 21
Total Lumens: 909
Source: 96 White LED's

LTL# 695287

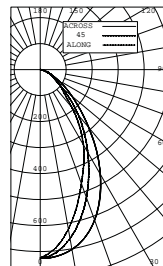

ZONAL LUMEN SUMMARY

Zone	Lumens	%Fixt
0-30	443	48.71
0-40	633	69.58
0-60	842	92.63
0-90	909	100.00
40-90	277	30.42
60-90	67	7.37
90-180	0	0.00
0-180	909	100.00

Efficacy = 43.3 Lumens /Watt

COEFFICIENTS OF UTILIZATION

Effective Floor Cavity Reflectance 20%

RC	80			
RW	70	50	30	10
ROR				
0	1.19	1.19	1.19	1.19
1	1.12	1.09	1.06	1.04
2	1.06	1.00	0.96	0.92
3	0.99	0.92	0.87	0.82
4	0.94	0.85	0.79	0.74
5	0.88	0.79	0.72	0.67
6	0.83	0.73	0.66	0.62
7	0.78	0.68	0.61	0.56
8	0.74	0.63	0.56	0.52
9	0.69	0.58	0.52	0.47
10	0.65	0.54	0.48	0.43

LINEA 1.5" MINI DIRECT STRAIGHT BLADE LOUVER 10W 3500K 4FT

Total Watts: 42
Total Lumens: 1,599
Source: 96 White LED's

LTL# 695288

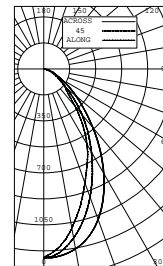

ZONAL LUMEN SUMMARY

Zone	Lumens	%Fixt
0-30	776	48.51
0-40	1109	69.33
0-60	1479	92.46
0-90	1599	100.00
40-90	491	30.67
60-90	121	7.54
90-180	0	0.00
0-180	1599	100.00

Efficacy = 38.4 Lumens /Watt

COEFFICIENTS OF UTILIZATION

Effective Floor Cavity Reflectance 20%

RC	80			
RW	70	50	30	10
ROR				
0	1.19	1.19	1.19	1.19
1	1.12	1.09	1.06	1.03
2	1.06	1.00	0.96	0.92
3	0.99	0.92	0.86	0.82
4	0.94	0.85	0.79	0.74
5	0.88	0.79	0.72	0.67
6	0.83	0.73	0.66	0.62
7	0.78	0.67	0.61	0.56
8	0.73	0.63	0.56	0.51
9	0.69	0.58	0.52	0.47
10	0.65	0.54	0.48	0.43

Linea[®] 1.5" Mini Direct

Linear Mini Direct, Remote Driver



PROJECT:

TYPE:

FIXTURE DATA: (Complete photometric data (.ies format) available upon request)

MULTIPLYING FACTORS: (Multiplying Factor is based on 3000K-83 120V IES file on website)

Wattage:	3W	4W	5W	6W	7W	8W	9W
Factor:	0.63	0.82	1.0	1.17	1.34	1.50	1.64

CCT:	2700K-83	3000K-83	3500K-83	4000K-83
Factor:	0.93	1.0	1.08	1.15

LINEA 1.5" MINI DIRECT ASYMMETRIC LENS 5W 3000K 4FT

Total Watts: 19
Total Lumens: 1,649
Source: 96 White LED's

LTL# 1103575

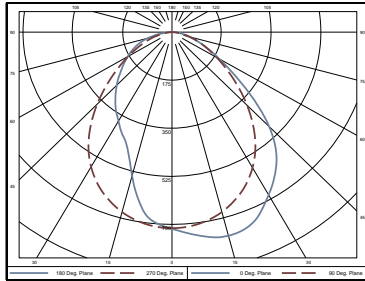

ZONAL LUMEN SUMMARY

Zone	Lumens	%Fixt
0-40	836	50.7
0-60	1376	83.4
0-90	1649	100.00
90-180	0	0.00

Efficacy = 85.4 Lumens /Watt

COEFFICIENTS OF UTILIZATION

Effective Floor Cavity Reflectance 20%

RC	RW			
	70	50	30	10
ROR (values expressed as lumens delivered to task surface)				
0	1963	1963	1963	1963
1	1807	1734	1668	1609
2	1654	1527	1421	1332
3	1517	1352	1225	1124
4	1395	1207	1069	964
5	1288	1085	943	839
6	1193	982	840	739
7	1109	894	755	658
8	1035	819	684	591
9	969	754	623	535
10	910	698	571	487

LINEA 1.5" MINI DIRECT ASYMMETRIC LENS 10W 3000K 4FT

Total Watts: 39
Total Lumens: 3,002
Source: 96 White LED's

LTL# 1103574

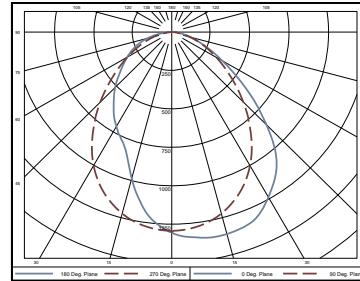

ZONAL LUMEN SUMMARY

Zone	Lumens	%Fixt
0-40	1508	50.2
0-60	2494	83.1
0-90	3002	100.00
90-180	0	0.00

Efficacy = 77.5 Lumens /Watt

COEFFICIENTS OF UTILIZATION

Effective Floor Cavity Reflectance 20%

RC	RW			
	70	50	30	10
ROR (values expressed as lumens delivered to task surface)				
0	3574	3574	3574	3574
1	3287	3153	3033	2925
2	3008	2774	2581	2419
3	2756	2456	2223	2038
4	2534	2190	1939	1746
5	2339	1968	1709	1518
6	2166	1780	1522	1336
7	2013	1621	1367	1188
8	1878	1484	1237	1067
9	1758	1366	1127	965
10	1651	1264	1033	879

LINEA 1.5" MINI DIRECT GRAZER LENS 5W 3500K* 4FT

Total Watts: 20
Total Lumens: 1,731
Source: 96 White LED's

LTL# 11723886.02

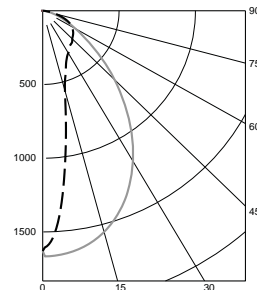

ZONAL LUMEN SUMMARY

Zone	Lumens	%Fixt
0-40	973	56.2
0-60	1461	84.4
0-90	1731	100.00
90-180	0	0.00

Efficacy = 87.9 Lumens /Watt

COEFFICIENTS OF UTILIZATION

Effective Floor Cavity Reflectance 20%

RC	RW			
	70	50	30	10
ROR (values expressed as lumens delivered to task surface)				
0	2013	2013	2013	2013
1	1860	1794	1735	1682
2	1712	1597	1501	1419
3	1579	1431	1314	1220
4	1463	1292	1165	1066
5	1361	1175	1044	945
6	1270	1077	944	848
7	1190	992	861	768
8	1119	919	791	702
9	1056	856	732	646
10	999	801	680	599

LINEA 1.5" MINI DIRECT GRAZER LENS 10W 3500K* 4FT

Total Watts: 39
Total Lumens: 3,106
Source: 96 White LED's

*See previous page for 3500K multipliers

LTL# 11723886.02

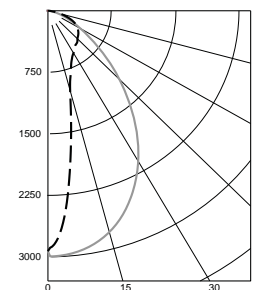

ZONAL LUMEN SUMMARY

Zone	Lumens	%Fixt
0-40	1747	56.2
0-60	2622	84.4
0-90	3106	100.00
90-180	0	0.00

Efficacy = 79 Lumens /Watt

COEFFICIENTS OF UTILIZATION

Effective Floor Cavity Reflectance 20%

RC	RW			
	70	50	30	10
ROR (values expressed as lumens delivered to task surface)				
0	3612	3612	3612	3612
1	3338	3220	3114	3018
2	3072	2866	2693	2547
3	2834	2568	2358	2189
4	2625	2319	2090	1914
5	2442	2110	1873	1697
6	2280	1932	1695	1522
7	2136	1781	1546	1379
8	2009	1650	1420	1260
9	1895	1537	1313	1160
10	1792	1438	1221	1075

Linea[®] 1.5" Mini Direct

Linear Mini Direct, Remote Driver



PROJECT:

TYPE:

DIMMING COMPATIBILITY:

Amerlux[®] Linea fixtures are compatible with all major dimming protocols prevalent in the United States. Please see below for general compatibilities and wiring diagrams. Amerlux recommends testing your unique dimming configuration as the exact full configuration (Dimmer, Fixture Quantity, Voltage, etc) may affect dimming performance.

0-10V - DIMMING (Standard)

Integrates into a variety of building management and daylighting controls

Notes:

- 120V or 277V*
- Dims down to 1% light output
- Requires interface to turn off power to driver
- Consult Dimming manufacturer for installation instructions - DO NOT SHARE NEUTRALS!

0-10V Wiring Diagram

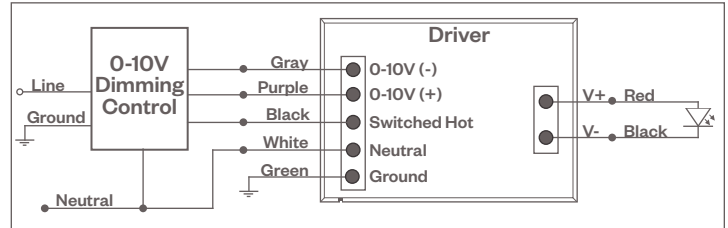

Compatible Dimmers

Wall Box

Lutron "Diva" - DVTV with PP-120H Interface

Leviton Renoir II 0-10v

Central System

Lutron Grafik Eye with GRX-TV1 Interface

LUTRON HI-LUME DIMMING

Integrates into Lutron EcoSystem building management

Notes:

- 120V or 277V*
- Dims down to less than 5% light output
- May use 3-Wire or EcoSystem Control
- Consult Dimming manufacturer for installation instructions - DO NOT SHARE NEUTRALS!

HILUME-A-DH

3-Wire Wiring Diagram

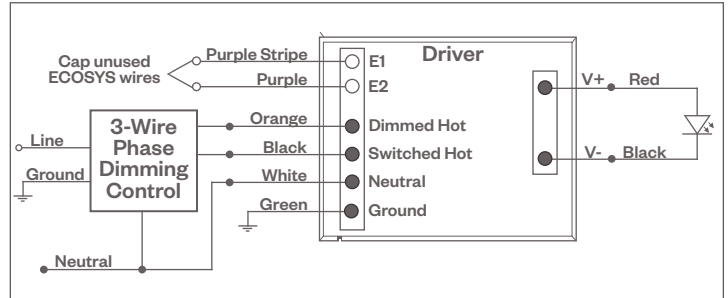

Compatible Dimmers

Wall Box (3-Wire Fluorescent)

DIVA
Maestro
Nova T
Vareo

Central System

Lutron EcoSystem compatible controls

HILUME-A-ECO, HILUME-H-ECO, HILUME-5-ECO

EcoSystem Digital Control Wiring Diagram

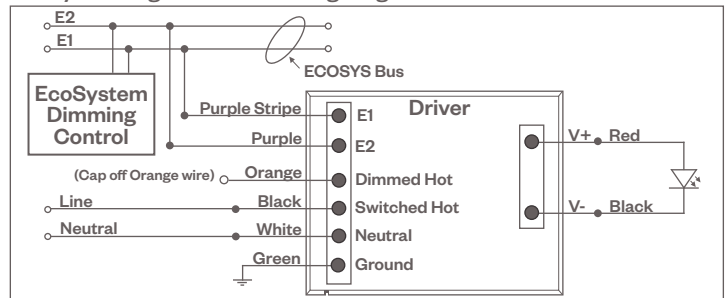

Notes:

- * Driver is 277V dimmable with appropriate dimmer (by others). All provided wiring diagrams show 120V wiring colors and method. Please refer to 277V dimmer installation instructions for 277V wiring diagrams.

Linea[®] 1.5" Mini Direct

Linear Mini Direct, Remote Driver



PROJECT:

TYPE:

DIMMING COMPATIBILITY:

Amerlux[®] Linea fixtures are compatible with all major dimming protocols prevalent in the United States. Please see below for general compatibilities and wiring diagrams. Amerlux recommends testing your unique dimming configuration as the exact full configuration (Dimmer, Fixture Quantity, Voltage, etc) may affect dimming performance.

LUTRON HILUME-A-LTE DIMMING

Utilizes "Standard" incandescent dimmers that are in wide use in installations across the US. Best for retrofit applications where TRIAC dimmers are installed.

Notes:

- 120V only
- Dims down to less than 1% light output (most cases)
- Consult Dimming manufacturer for installation instructions - DO NOT SHARE NEUTRALS!
- Must meet dimmer Minimum Load Requirements per dimming manufacturer

Lutron HILUME-A-LTE Wiring Diagram

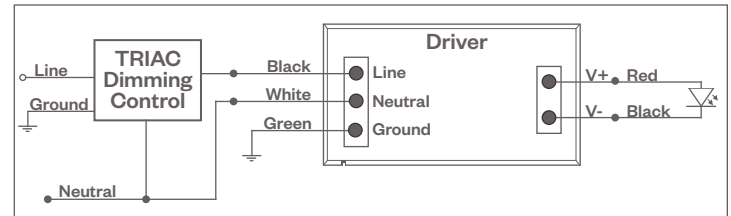

Compatible Dimmers

Wall Box (Incandescent Style, Wattage as required)

Lutron "Diva"	Lutron "Vareo"
Lutron "Nova-T"	Lutron "Skylark"
Lutron "Maestro"	

Central System

ETC "SR" Rack w/D20 Module	Lutron Grafik Eye QS
Lutron "GP" Panel	
ETC "DRD" Rack w/D20 Module	

DALI - DALI DIMMING 120V-277V

Digital control protocol allows individual fixture control

Notes:

- 120V - 277V*
- Dims down to 0.1% light output in most cases

DALI Wiring Diagram

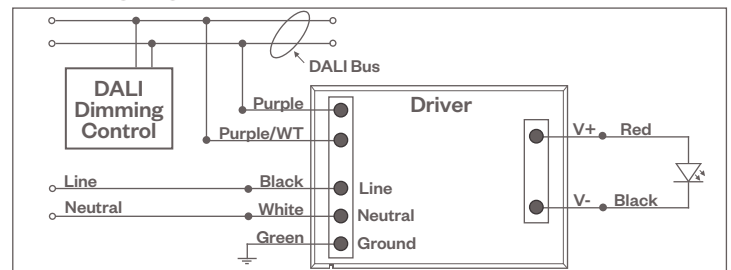

Compatible Dimmers

Wall Box (3-Wire Fluorescent)

Leviton CD250 Controller

Central System

Dynalite
Fifth Light

Notes:

* Driver is 277V dimmable with appropriate dimmer (by others). All provided wiring diagrams show 120V wiring colors and method. Please refer to 277V dimmer installation instructions for 277V wiring diagrams.