

GLOBAL TRACK 2 CIRCUIT/2 NEUTRAL 120V

TEK
2 CIR 120V

APPLICATION:

Power supply for Amerlux track lighting fixtures

LABELING:

cUL listed

CONSTRUCTION:

Architectural grade, extruded aluminum housing
Milled grounding bar provides continuous ground contact
Continuously crimped conductor ensures mechanical strength and electrical reliability
Black, white or natural aluminum

MOUNTING:

T-Grid, threaded rod or aircraft cable suspension
Max. 6' O.C. suspension points



PROJECT:

TYPE:

ELECTRICAL

2 circuit/2 neutral, 120v track
20 amps per circuit

Amerlux reserves the right to change details that do not affect overall function and performance.

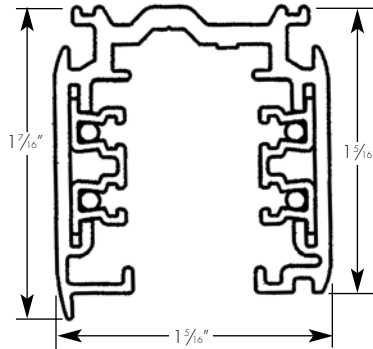

ORDERING INFORMATION:

TRACK Model	Finish	COMPONENTS* Model	Finish
TEK44 4' (48")	1 - natural aluminum	TEK11 - live end, left	1 - gray
TEK48 8' (96")	2 - black	TEK12 - live end, right	2 - black
TEK412 12' (144")	3 - white	TEK14 - live center feed	3 - white
		TEK21 - straight connector	
		TEK24 - adjustable connector	
		TEK34 - L connector, adjustable universal polarity	
		TEK38 - X connector	
		TEK39 - T connector, adjustable right polarity	
		TEK40 - T connector, adjustable left polarity	
		TEK41 - dead end	
		636-0171K - T-bar clip	
		636-0068 - cable gripper	
		614-0005 - aircraft cable 20'	
		675-0094K - J-box cover	
		SKB12-1 - ceiling clamp (for cable and rod mounting, aluminum finish only)	
		XTSV12 - bending tool	

Example: TEK48-2

Cat #:

*Components ordered separately

GLOBAL TRACK 2 CIRCUIT/2 NEUTRAL 120V

TEK
2 CIR 120V



TYPE :

TEK TRACK CONFIGURATION & COMPONENTS

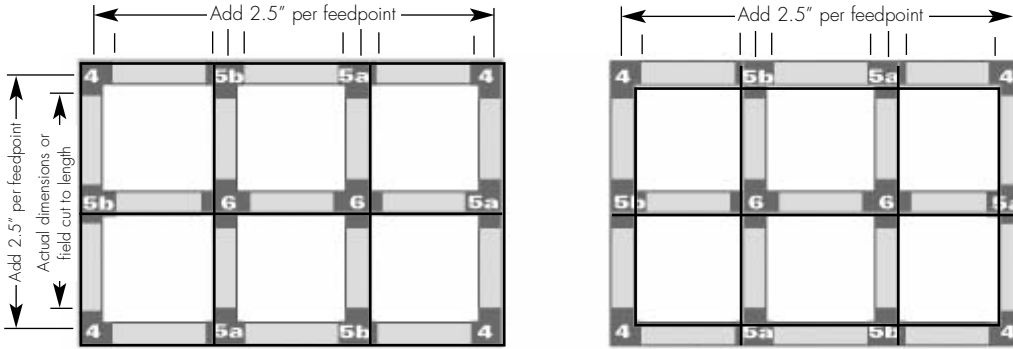
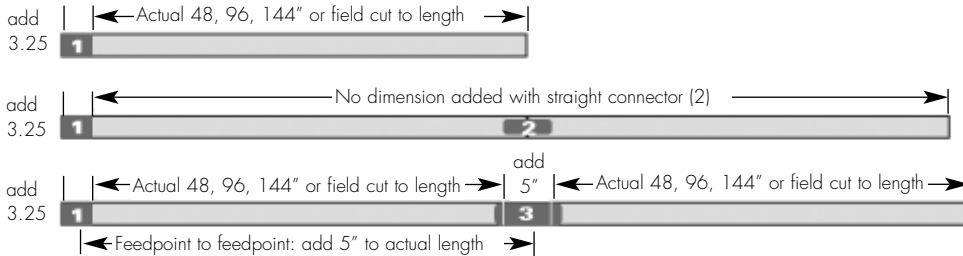

TEK is polarized and manufactured with identifying ridges (the larger shown as a bold line on diagrams). Refer to these diagrams to ensure proper connector selection.

Additional Accessories Not Pictured:

- SKB12-1 Ceiling Clamp
- 636-0171K T-Bar Clip
- 636-0068 Cable Gripper
- 614-0005 A/C Cable 20'
- 675-0094K J-box cover
- XTSV12 - bending tool



TEK 41 Dead End



TEK 24 Adjustable Connector

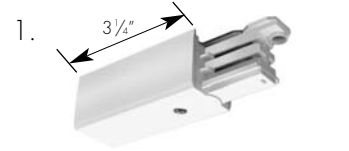

TEK 11 Live End (left) -standard
TEK 12 Live End (right)
(Used for Conduit feed also)



TEK 21 Straight Connector

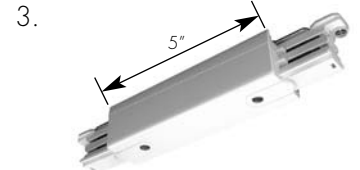

TEK 14 Live Center Feed

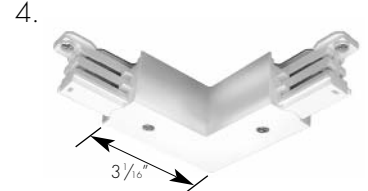

TEK 34 L Connector
(adjustable universal polarity)

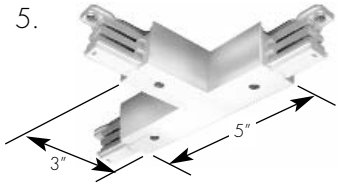

TEK 39 T Connector
(adjustable right polarity)
TEK 40 T Connector
(adjustable left polarity)

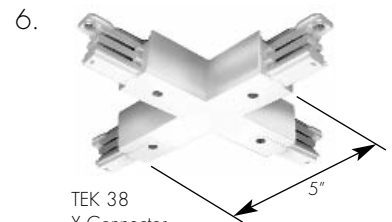

TEK 38
X Connector

SUSPENSION OPTIONS

T-GRID SUSPENSION

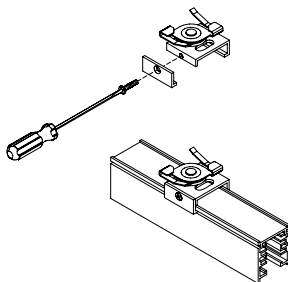

AIRCRAFT CABLE SUSPENSION

