

# CYLINDRIX MULTIPLE SEMI-RECESSED 2 LIGHT INTERNATIONAL

I-CYLSR-2  
2LT HIT-GU6.5

## APPLICATION:

Accent and display lighting for Retail, Commercial and Hospitality environments

## CONSTRUCTION:

Steel ballast mounting plate  
Steel upper housing and laser cut trim ring  
Die-cast lamp housing  
Formed aluminum yoke  
Powder coat paint

## ELECTICAL:

Electronic ballasts  
Terminal block for electrical connections  
GU6.5 TAL pulse rated socket

## OPTICS:

0-50° x 50° tilt, 360°+ rotation  
Available in a variety of beam spreads featuring Amerlux optics specifically designed for the HIT-GU6.5 lamp  
Available in custom tints to tune beam to provide incandescent-like hue

## MOUNTING:

Swing out lugs permit from below mounting into ceiling up to 1 1/2" (38 mm) thick

## LABELING:

CE CCC pending



PROJECT:

TYPE:

**ECOTEKTURAL**

Architectural lighting for sustainable design.

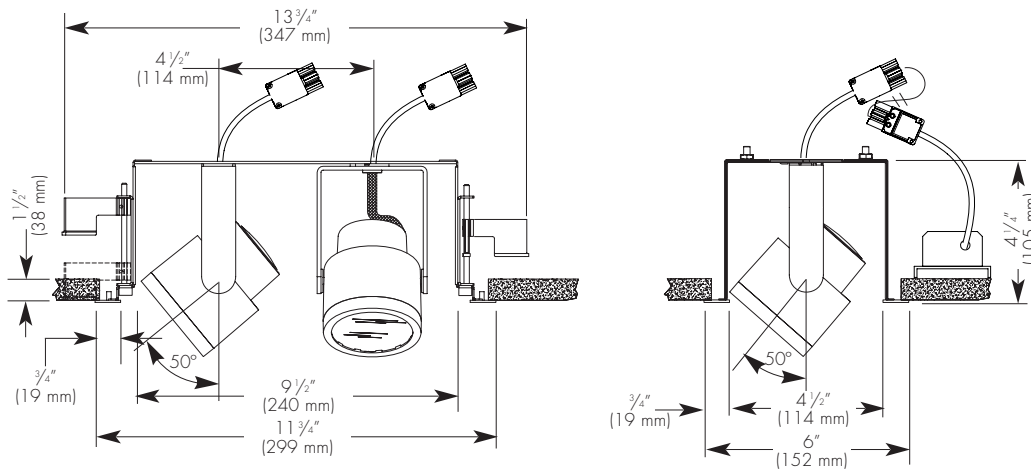

Ceiling Cut Out Dimension: 11 1/4" x 5 1/2"  
(286 mm x 140 mm)

## ELECTRICAL

Ballast	Lamping			
	2-20w		2-35w	
	Input watts	Amps*	Input watts	Amps*
Electronic 220v	48	.38	88	.40
240v	48	.30	86	.36

\*Data is for open circuit current

2 HIT-GU6.5 base metal halide, 20w and 35w

Amerlux reserves the right to change details that do not affect overall function and performance.

## OPTIONAL: TO EXCLUDE GEAR

ORDER LG OPTION (BALLAST/TRANSFORMER SUPPLIED BY OTHERS)

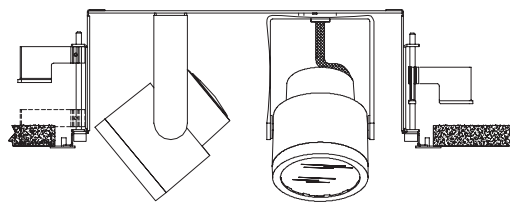

## ORDERING INFORMATION:

Model	# Lamps	Wattage	Lamp Type	Ballast	Housing/Head Finish	Voltage	Beam Spreads (specify each head)	Trim Ring Finish	Options/Accessories	Listing Code
I-CYLSR	2	20 35	HIT-GU6.5 (T4GU6.5)	E - electronic	WT - white texture BT - black texture ST - silver texture - (other RAL)	220-240	CL - spot, 12° NF - narrow flood, 18° FL - flood, 25° WF - wide flood, 40° SL - linear spread lens, 5° x 55°	WT - white texture	DB2690 - DB2690 optic reflector GOLD - ferric gold optic reflector HEX - hexcell louver SN - snoot (1/2" length standard), specify color (WT, BT, ST) CB* - cross blade, specify color (BT), black texture standard	CE CCC

Example: I-CYLSR-2-20-HIT-GU6.5-E-WT-220-240-FL-FL-WT-CE

Cat #:

\*Note: Cross Blade requires snoot be specified

## To Exclude Gear

LG - less gear



# CYLINDRIX MULTIPLE SEMI-RECESSED 2 LIGHT INTERNATIONAL

I-CYLSR-2  
2LT HIT-GU6.5



TYPE :

**ECOTECTURAL**  
Architectural lighting for sustainable design.



**FIXTURE DATA:**

Test run with standard clear reflector. For gold, multiply by 0.9; For sunrise, multiply by .87  
For 39w data, multiply by 2.1

Complete photometric data (.ies format) available upon request.

Note: Data is for 1 lamp

**20W HIT-GU6.5**

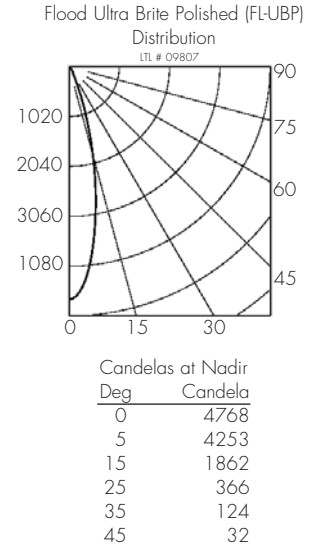
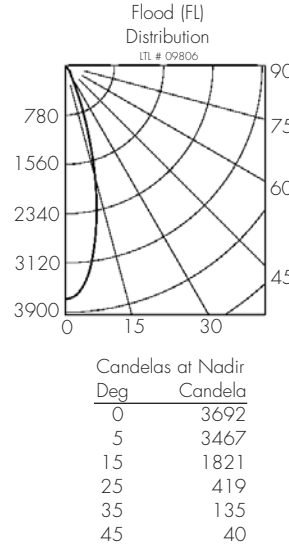
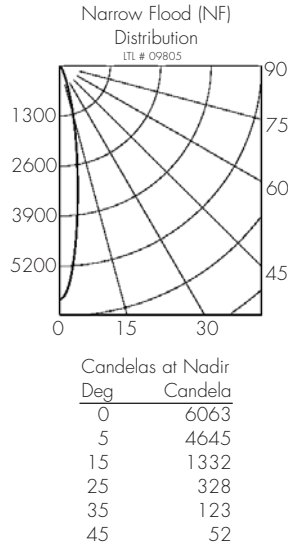
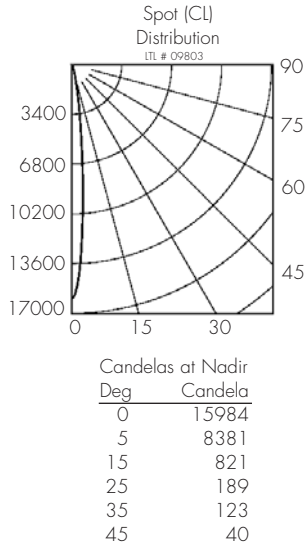

**APPLICATION DATA:**

**Notes and Definitions:**

Beam spread is to 50% center beam candlepower (CBCP).  
D=Distance to floor or wall.  
FC=Footcandles on floor or wall at center beam aiming location.  
L=Effective Visual Beam length in feet (50% of maximum footcandle level).  
W=Effective Visual Beam width in feet (50% of maximum footcandle level).  
CB=Distance across or down to center beam location.

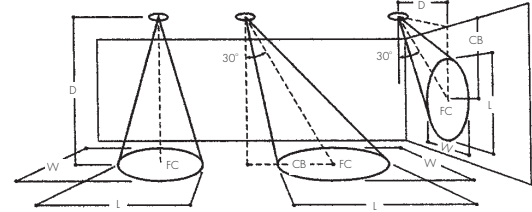

0° Aiming Angle  
Horizontal  
Footcandles



30° Aiming Angle  
Horizontal  
Footcandles



30° Aiming Angle  
Vertical  
Footcandles



60° Aiming Angle  
Vertical  
Footcandles

	0° Aiming Angle Horizontal Footcandles					30° Aiming Angle Horizontal Footcandles					30° Aiming Angle Vertical Footcandles					60° Aiming Angle Vertical Footcandles				
	D	FC	L	W	CB	D	FC	L	W	CB	D	FC	L	W	CB	D	FC	L	W	CB
SPOT	5.0'	609	1.1	1.1		5.0'	373	1.2	1.1	3.0	3.0'	223	2.1	1.1	4.8	3.0'	1082	0.7	0.6	1.8
	7.5'	271	1.4	1.4		7.5'	168	2.0	1.6	4.0	4.0'	124	2.8	1.5	6.7	4.0'	619	0.9	0.8	2.2
	10.0'	152	1.8	1.8		10.0'	93	2.6	2.3	6.0	5.0'	81	3.5	1.8	8.2	5.0'	392	1.3	1.1	2.7
	12.5'	97	2.4	2.4		12.5'	63	3.2	2.8	7.0	6.0'	56	4.2	2.2	9.8	6.0'	267	1.5	1.4	3.3
NARROW FLOOD	5.0'	243	1.5	1.5		5.0'	148	2.2	1.8	3.0	3.0'	97	3.2	1.8	4.2	3.0'	431	1.2	1.1	1.7
	7.5'	108	2.3	2.3		7.5'	70	3.1	2.7	4.0	4.0'	55	4.3	2.3	5.7	4.0'	247	1.6	1.5	2.2
	10.0'	61	3.1	3.1		10.0'	38	4.3	3.6	5.0	5.0'	35	5.3	2.8	7.2	5.0'	158	2.0	1.8	2.7
	12.5'	39	3.8	3.8		12.5'	25	5.1	4.4	7.0	6.0'	25	6.4	3.5	8.7	6.0'	110	2.4	2.1	3.2
FLOOD	5.0'	148	2.6	2.6		5.0'	98	3.1	2.8	2.0	3.0'	80	3.4	2.4	3.7	3.0'	277	1.9	1.7	1.3
	7.5'	66	3.7	3.7		7.5'	45	4.7	4.3	4.0	4.0'	46	4.4	3.1	4.8	4.0'	159	2.4	2.2	1.8
	10.0'	37	5.0	5.0		10.0'	26	6.0	5.5	5.0	5.0'	29	5.6	4.0	5.6	5.0'	102	3.0	2.8	2.3
	12.5'	24	6.2	6.2		12.5'	17	7.6	6.7	6.0	6.0'	20	6.7	4.7	7.2	6.0'	71	3.6	3.3	2.7
FLOOD UBP	5.0'	191	2.2	2.2		5.0'	119	2.9	2.6	3.0	3.0'	93	3.4	2.2	3.7	3.0'	340	1.7	1.5	1.8
	7.5'	85	3.3	3.3		7.5'	57	4.1	3.7	4.0	4.0'	52	4.5	2.9	5.3	4.0'	196	2.02	2.0	2.2
	10.0'	48	4.3	4.3		10.0'	32	5.4	4.9	5.0	5.0'	33	5.6	3.6	6.2	5.0'	127	2.8	2.5	2.8
	12.5'	31	5.4	5.4		12.5'	20	6.8	6.1	6.0	6.0'	23	6.7	4.4	7.8	6.0'	88	3.3	3.0	3.3