

Rook® 350

3.5" Square Wall Mount
Direct/Indirect
Dim-To-Warm



Features

The contemporary Rook 350 Direct/Indirect Wall Mount provides both direct and indirect illumination. Both the downlight and uplight have the same optical performance as our Hornet 3.5" Downlights. With only a 3.5" aperture the Rook 350 D/I can be used to add visual interest to walls or columns. The Rook 350 cylinder family is available as a pendant, surface or wall mount allowing it to fit in any retail, hospitality or commercial environment. Our Dim-To-Warm option allows designers to simulate the familiar glow and dimming of incandescent lamps. By shifting to a lower Kelvin temperature, as you dim the lights, Dim-To-Warm can tap into the powerful mediums of light and color to enhance the experience and well-being.

Product Overview

Type:	Square Wall Mount, Direct/Indirect
Wattage (Down or Up):	13W
Lumen Output (Down or Up):	672 lm (RK350WS); 841 (RK350WSL)
CBCP:	up to 3179 (RK350WS); 2380 (RK350WSL)
Color Temp:	3000K to 1800K
CRI:	95 typ.
Dimming:	TRIAC & ELV (120V/277V) - 5% Dim 0-10V (120V/277V) - 1% Dim

Wall Mount

Remote Wall Mount

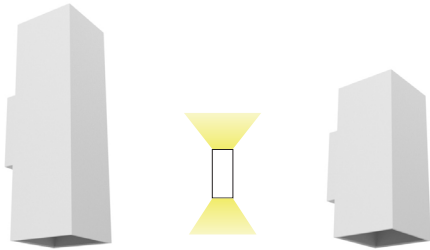

See page 4 for other mounting options

PROJECT:

TYPE:

Performance Chart - Down or Up Output

Watts	Delivered Lumens	LPW	CBCP	Color Temp
RK350WS				
13	672	51.7	3179	3000K-95
RK350WSL				
13	841	64.7	2380	3000K-95

Electrical Data

	26W	
	System Watts	Amps
120V	26	0.22
277V	26	0.09

Electronic constant current LED driver

Max. Fixture Weights

Model	Weight (lbs)
RK350WS(L)-DI	7.3
RK350WS(L)-DI-REMOTE	5.4

Remote driver & driver box are not included in weight

Dim-To-Warm CCT Curve

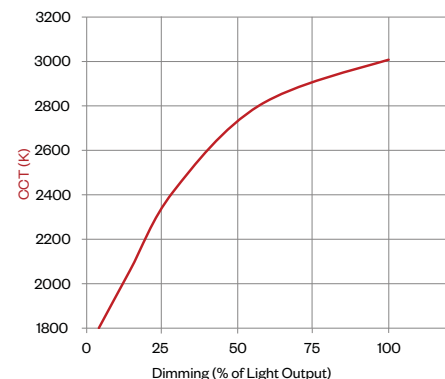

Rook® 350

3.5" Square Wall Mount, Direct/Indirect, Dim-To-Warm



PROJECT:

TYPE:

Ordering Information

_____ . 13/13 . _____ . 120-277 . _____ / _____ . 309 . _____

1

2

3

4

5

6

7

8

9

10

Open Unit

1 Model
RK350WS-DI-DTW
RK350WS-DI-DTW-REMOTE (remote driver)

2 Wattage (Direct/Indirect)
Direct Indirect
13 **13**

3 Housing Finish
MW - matte white
MB - matte black
SLV - matte silver

4 Circuiting
1 - single circuit
2 - direct/indirect switch separately

5 Mounting (matches housing finish)
WM - wall mount (no wall plate)
CWM - wall mount with wall plate
CDWM - wall mount conduit cover

6 Voltage
120-277

7 Trim Finish
MW - matte white
MB - matte black
SLV - matte silver

8 Beam Spread (Direct/Indirect)
Direct Indirect
VNF - narrow flood, 18° **VNF** - narrow flood, 18°
MFL - medium flood, 24° **MFL** - medium flood, 24°
FL - flood, 28° **FL** - flood, 28°
WF - wide flood, 45° **WF** - wide flood, 45°

9 Color Temp
95 CRI
309 - 3000K-95

10 Driver
LE/TE - TRIAC/ELV dimming; 5% dim
O-10V - 0-10V dimming; 1% dim

Lensed Unit

1 Model
RK350WSL-DI-DTW (Lensed)
RK350WSL-DI-DTW-REMOTE (Lensed, remote driver)

2 Wattage (Direct/Indirect)
Direct Indirect
13 **13**

3 Housing Finish
MW - matte white
MB - matte black
SLV - matte silver

4 Circuiting
1 - single circuit
2 - direct/indirect switch separately

5 Mounting (matches housing finish)
WM - wall mount (no wall plate)
CWM - wall mount with wall plate
CDWM - wall mount conduit cover

6 Voltage
120-277

7 Trim Finish
MW - matte white
MB - matte black
SLV - matte silver

8 Beam Spread (Direct/Indirect)
Direct Indirect
30SOL - 30° solite lens **30SOL** - 30° solite lens
50SOL - 50° solite lens **50SOL** - 50° solite lens
65SOL - 65° solite lens **65SOL** - 65° solite lens

9 Color Temp
95 CRI
309 - 3000K-95

10 Driver
LE/TE - TRIAC/ELV dimming; 5% dim
O-10V - 0-10V dimming; 1% dim

Note: Fixture provided with separate wires for down and up. Can be wired in field as single or dual circuit.

Rook® 350

3.5" Square Wall Mount, Direct/Indirect, Dim-To-Warm



PROJECT:

TYPE:

Specifications

Application

Commercial, hospitality and retail ambient/accent wall mounted fixtures

Construction

Extruded aluminum pendant housing
Die-cast trim
Extruded aluminum heat sink

Optical

RK350WS-DI Beam Spreads:
Very Narrow Flood, 18°; Medium Flood, 24°; Flood, 35°;
Wide Flood, 44°
RK350WSL-DI Beam Spreads:
Solite Lens for maximum efficacy and a visually quieter aperture. 30°, 50° & 65° beam spread options. Visually best with SLV reflector finish.

LED

Color Temp Options:
3000K (Dims to 1800K)
CRI: 95 typ. (± 3 across dimming range)
R9 Values: 85
Binning: 3 MacAdam (SDCM)
Life: 50,000+ hrs, > 70% of initial lumens at 50,000 hrs

Electrical

Wattage: 13W Down/13W Up
Electronic constant current LED driver, 120V-277V input
This product complies with IEEE C62.41 for surge endurance up to 2.5KV. Amerlux® recommends using additional surge protection with this unit (supplied by others), surge and over voltage damage is not covered under warranty.
For emergency: Remote EM inverter or emergency circuit by others
Remote Driver Wiring: Driver is supplied installed in remote driver box, (one driver per box), with 5' of low voltage plenum rated cable. Amerlux recommends a maximum of 15' between the fixture and the remote driver box. Consult factory with job specific electrical spec if more than 15' is required.
Note: Fixture provided with separate wires for down and up. Can be wired in field as single or dual circuit.

Drivers

LE/TE - Leading Edge, TRIAC, forward phase/Trailing Edge, ELV, reverse phase
0-10V and Lutron also available see ordering page

Finish

Powder coat paint
Consult factory for custom finishes

Mounting

Wall mounted, see options on pg 4

Certifications

CSA tested to UL standards
Indoor use only
Damp location

Warranty

5 year limited warranty

Rook® 350

3.5" Square Wall Mount, Direct/Indirect, Dim-To-Warm



PROJECT:

TYPE:

Wall Mount

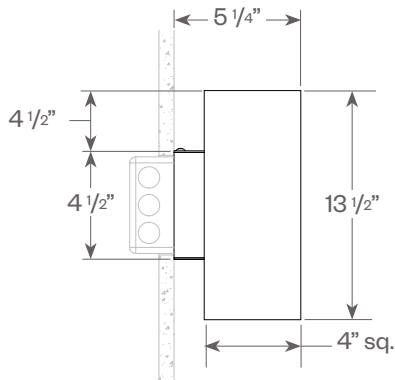

Fixture	A	B
RK350W(S/SL)-DI	13 1/2"	4 1/2"
RK350W(S/SL)-DI-REMOTE	9 1/2"	2 1/2"

Wall Mount with Wall Plate

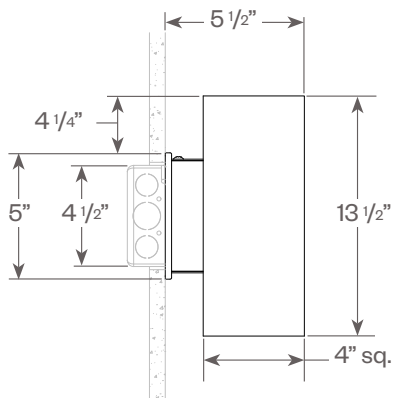

Fixture	A	B
RK350W(S/SL)-DI	13 1/2"	4 1/4"
RK350W(S/SL)-DI-REMOTE	9 1/2"	2 1/4"

Wall Mount Conduit Cover

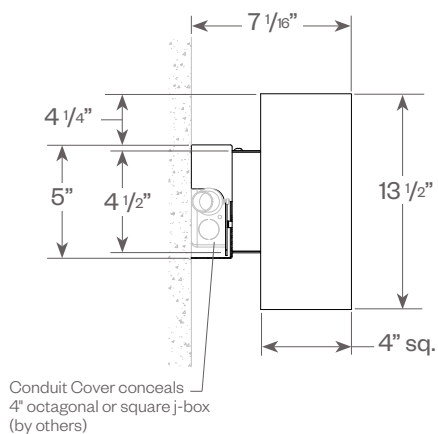

Fixture	A	B
RK350W(S/SL)-DI	13 1/2"	4 1/4"
RK350W(S/SL)-DI-REMOTE	9 1/2"	2 1/4"

Remote Driver Box

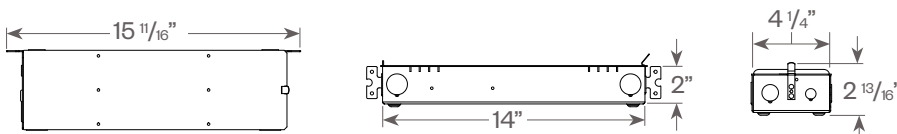

Driver is supplied installed in remote driver box, (one driver per box), with 15' of low voltage plenum rated cable. Amerlux recommends a maximum of 15' between the fixture and the remote driver box. Consult factory with job specific electrical spec if more than 15' is required.

Rook® 350

3.5" Square Wall Mount, Direct/Indirect, Dim-To-Warm



PROJECT:

TYPE:

RK350WS

FIXTURE DATA: (Complete photometric data (.ies format) available upon request)

13W LED, 3000K-95

Very Narrow Flood (VNF)
Distribution, 18°
LTL #11919582.12
Lumens: 672

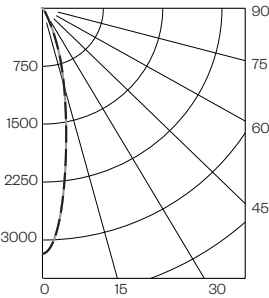

Candelas at Nadir

Deg	Candela
0	3179
5	2638
15	1030
25	252
35	43
45	10

Medium Flood (MFL)
Distribution, 25°
LTL #11919582.13
Lumens: 609

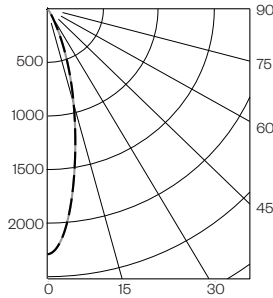

Candelas at Nadir

Deg	Candela
0	2291
5	2024
15	942
25	267
35	50
45	11

Flood (FL)
Distribution, 35°
LTL # 11919582.14
Lumens: 582

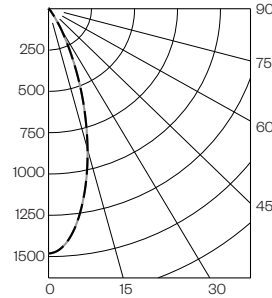

Candelas at Nadir

Deg	Candela
0	1481
5	1395
15	882
25	331
35	63
45	13

Wide Flood (WF)
Distribution, 45°
LTL # 11919582.15
Lumens: 540

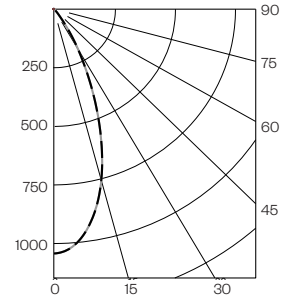

Candelas at Nadir

Deg	Candela
0	1042
5	1007
15	751
25	359
35	85
45	15

Application Data:

RK350WR Mounted at 7' (to bottom of fixture) on wall
Footcandles on wall

Very Narrow Flood

Distance from fixture	Footcandle distribution								
	0.5	0	0	1	51	52	0	0	0
1.5	0	0	1	40	48	1	0	0	0
2.5	0	0	2	17	20	2	0	0	0
3.5	0	0	2	8	9	2	0	0	0
4.5	0	1	2	5	5	2	1	0	0
5.5	1	1	2	4	4	2	1	0	0
6.5	1	1	2	4	4	2	1	1	0

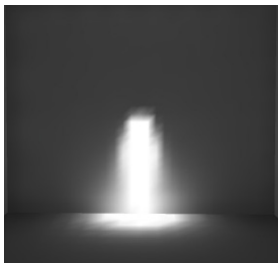

Medium Flood

Distance from fixture	Footcandle distribution								
	0.5	0	0	0	50	54	0	0	0
1.5	0	0	1	37	45	1	0	0	0
2.5	0	0	2	14	16	2	0	0	0
3.5	0	0	2	7	7	2	0	0	0
4.5	0	1	2	4	4	2	1	1	0
5.5	0	1	2	3	3	2	1	0	0
6.5	0	1	2	3	3	2	1	0	0



Flood

Distance from fixture	Footcandle distribution								
	0.5	0	0	1	60	49	0	0	0
1.5	0	0	2	35	37	2	0	0	0
2.5	0	0	2	12	13	2	0	0	0
3.5	0	1	2	5	6	2	0	0	0
4.5	0	1	2	3	3	2	1	0	0
5.5	1	1	2	3	3	2	1	0	0
6.5	1	1	2	2	2	2	1	1	0



Wide Flood

Distance from fixture	Footcandle distribution								
	0.5	0	0	1	50	62	0	0	0
1.5	0	0	2	29	39	2	0	0	0
2.5	0	0	2	9	10	3	0	0	0
3.5	0	1	2	4	4	2	1	0	0
4.5	0	1	2	3	3	2	1	0	0
5.5	1	1	2	2	2	2	1	1	0
6.5	0	1	1	1	1	1	1	1	0

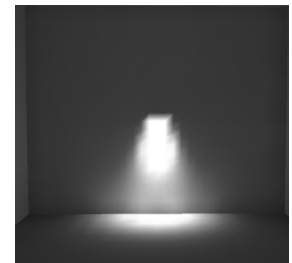

Rook® 350

3.5" Square Wall Mount, Direct/Indirect, Dim-To-Warm



PROJECT:

TYPE:

RK350WSL

FIXTURE DATA: (Complete photometric data (.ies format) available upon request)

13W LED, 3000K-95

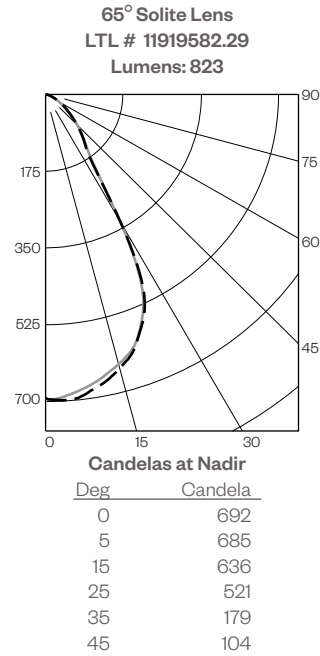
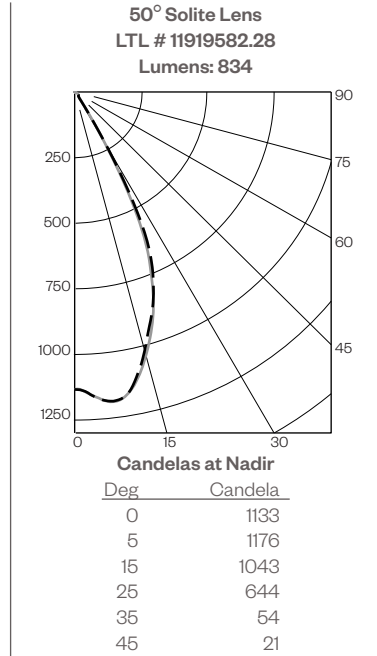
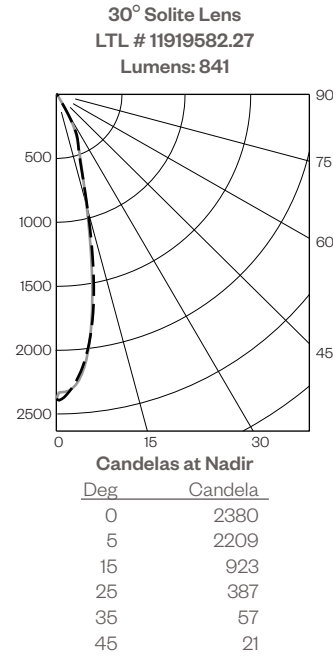

Application Data:

RK350WSL Mounted at 7' (to bottom of fixture) on wall
Footcandles on wall

30SOL

Distance from fixture	Footcandle distribution							
	0.5	1.5	2.5	3.5	4.5	5.5	6.5	7.5
0.5	0	0	1	81	83	1	0	0
1.5	0	0	2	45	54	2	0	0
2.5	0	0	3	16	19	3	0	0
3.5	0	1	2	7	8	3	1	0
4.5	1	1	2	5	5	2	1	1
5.5	1	1	2	4	4	2	1	1
6.5	1	1	2	4	4	2	1	1



50SOL

Distance from fixture	Footcandle distribution							
	0.5	1.5	2.5	3.5	4.5	5.5	6.5	7.5
0.5	0	0	1	88	96	1	0	0
1.5	0	0	3	45	58	3	0	0
2.5	0	0	3	13	14	4	0	0
3.5	0	1	3	5	5	3	1	0
4.5	1	1	2	3	3	3	1	1
5.5	1	1	2	3	3	2	1	1
6.5	1	1	2	2	2	2	1	1



65SOL

Distance from fixture	Footcandle distribution							
	0.5	1.5	2.5	3.5	4.5	5.5	6.5	7.5
0.5	0	0	3	111	99	2	0	0
1.5	0	1	4	30	32	4	1	0
2.5	0	1	3	8	9	3	1	0
3.5	1	1	2	3	4	2	1	1
4.5	1	1	2	2	2	2	1	1
5.5	1	1	1	2	2	1	1	1
6.5	1	1	1	1	1	1	1	1

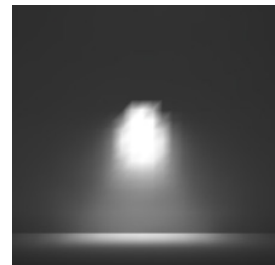

Rook® 350

3.5" Square Wall Mount, Direct/Indirect, Dim-To-Warm



PROJECT:

TYPE:

DIMMING COMPATIBILITY:

Amerlux® Rook fixtures are compatible with all major dimming protocols prevalent in the United States. Please see below for general compatibilities and wiring diagrams. Amerlux recommends testing your unique dimming configuration as the exact full configuration (Dimmer, Fixture Quantity, Voltage, etc) may affect dimming performance.

--- NOTE: INFORMATION BELOW IS FOR WIRED DIMMERS ONLY. FOR WIRELESS DIMMERS, CONSULT FACTORY ---

TRIAC (Forward Phase) DIMMING (Standard)

Utilizes standard TRIAC dimmers that are in wide use in installations across the US. Best for retrofit applications where TRIAC dimmers are installed.

Notes:

- 120VAC or 277VAC*
- Dims down to 5% light output (most cases)
- Consult Dimming manufacturer for installation instructions - DO NOT SHARE NEUTRALS!
- Must meet dimmer Minimum Load Requirements per dimming manufacturer

TRIAC Wiring Diagram

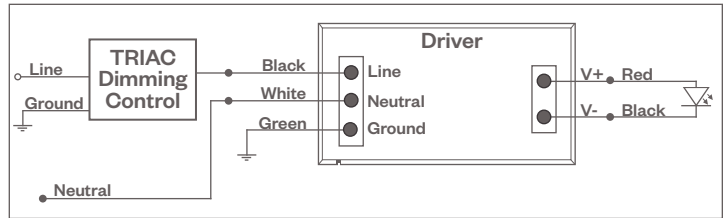

Compatible Dimmers†:

Wall Box (TRIAC 120VAC)	Central System
Lutron "Diva"	Lutron "GP" Panel
Lutron "Nova-T"	Lutron Grafik Eye QS
Lutron "Maestro"	
Lutron "Vareo"	
Lutron "Skylark"	

ELV - Electronic Low Voltage (Reverse Phase) DIMMING (Standard)

Utilizes specialized "ELV" dimmers.

Notes:

- 120VAC or 277VAC*
- Dims down to 5% light output (most cases)
- Consult Dimming manufacturer for installation instructions - DO NOT SHARE NEUTRALS!
- Must meet dimmer Minimum Load Requirements

ELV Wiring Diagram

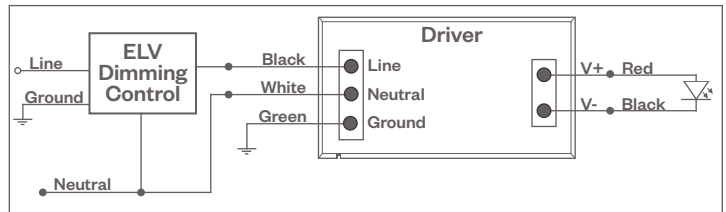

Compatible Dimmers†:

Wall Box (ELV 120VAC)	Wall Box (ELV 277VAC)	Central System
Lutron "Diva"	Leviton Revoir II AWSMT-E	Lutron "GP" Panel with PHPM-PA 120/277VAC
Lutron "Nova-T"		Lutron Grafik Eye QS with PHPM-PA 120/277VAC
Lutron "Maestro"		
Lutron "Vareo"		
Lutron "Skylark"		
Leviton "Surslide"		
Leviton "Vizio"		

Notes:

- * Driver is 277VAC dimmable with appropriate dimmer (by others). All provided wiring diagrams show 120VAC wiring colors and method. Please refer to 277VAC dimmer manufacturer installation instructions for 277VAC wiring diagrams.
- † The absence of a dimmer from the lists above does not imply incompatibility. Please consult factory for compatibility inquiries.

Rook® 350

3.5" Square Wall Mount, Direct/Indirect, Dim-To-Warm



PROJECT:

TYPE:

DIMMING COMPATIBILITY:

Amerlux® Rook fixtures are compatible with all major dimming protocols prevalent in the United States. Please see below for general compatibilities and wiring diagrams. Amerlux recommends testing your unique dimming configuration as the exact full configuration (Dimmer, Fixture Quantity, Voltage, etc) may affect dimming performance.

--- NOTE: INFORMATION BELOW IS FOR WIRED DIMMERS ONLY. FOR WIRELESS DIMMERS, CONSULT FACTORY ---

0-10V - DIMMING (-0-10V Option)

Integrates into a variety of building management and daylighting controls

Notes:

- 120V or 277V*
- Dims down to 1% light output
- Requires interface to turn off power to driver
- Consult Dimming manufacturer for installation instructions - DO NOT SHARE NEUTRALS!

0-10V Wiring Diagram

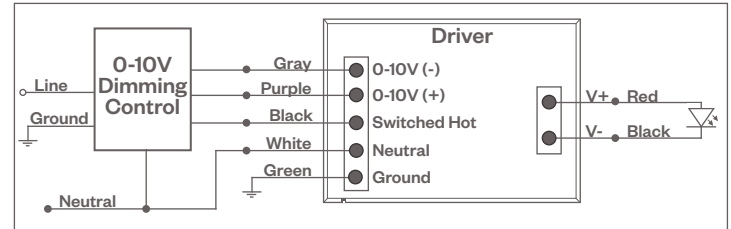

Compatible Dimmers*:

Wall Box

Lutron "Diva" - DTVV with PP-120H Interface

Leviton Renoir II 0-10V

Central System

Lutron Grafik Eye with GRX-TVI Interface

Notes:

- * Driver is 277VAC dimmable with appropriate dimmer (by others). All provided wiring diagrams show 120VAC wiring colors and method. Please refer to 277VAC dimmer manufacturer installation instructions for 277VAC wiring diagrams.
- † The absence of a dimmer from the lists above does not imply incompatibility. Please consult factory for compatibility inquiries.