

Contour[®]

4x4

Track Head



Features

Contour 4x4 represents the most powerful LED track accent on the market and is ideal for punching through high ambient light levels as well as applications where mounting heights exceed 10'. High performance optics and excellent thermal design delivers superior performance.

Product Overview

Type:	Track Accent & Display
Wattage:	32
Lumen Output:	2,221 max; 69.4 Lm/W (NF optic)
OBCP:	22,906 max (NF optic)
Color Temp:	2700K, 3000K, 3500K, 4000K
CRI:	83 typ. (2700K, 3000K, 3500K, 4000K)
Dimming:	Optional ELV (120V only)

PROJECT:

TYPE:

Fixture Summary *(see following pages for more information)*

Performance Chart

Watts	Delivered Lumens	LPW	OBCP	Color Temp
32	2,221	69.4	22,906	2700K-83

Data is based on 2700K-83 120V IES files available on website

Data is based on Narrow Flood optic

See pg 5 for other beam spreads

Electrical Data

	32W	
	System Watts	Amps
120V	32	0.27
277V	32	0.12

Electronic constant current LED driver



5 year limited warranty
AMERLUX LED



Contour[®] 4X4

Track Head



PROJECT:

TYPE:

Ordering Information



1 Model
CNTRV44

2 Wattage
32

3 Finish
WT - white texture
BT - black texture
ST - silver texture
Other finishes, consult factory

4 Mounting
TN1 - Global GES 1cir/H-Style, 120V
TEK - Global TEK 2cir/2neut, 120V
TN3 - Global XTS 3cir, 120V
TN2 - Global HTEK 2cir/2neut, 277V
CT - J-Style, 120V
LOL - L-Style, 120V
CPR - Capri, 120V
B* - busway, 120V or 277V
C - canopy, 120V or 277V
CCL2-SCP - C-clamp, black, with straight cord**, 6', 120V
CCL2-CCP - C-clamp, black, with coil cord**, 5', 120V
Notes: *Busway compact series B40,B60c only, consult factory for other busway adapters. Black busway adapter used for ST finish
**Black cord used for BT & ST finish, White cord used for WT finish

5 Voltage
120
277

6 Beam Spreads (see additional details)
NF - narrow flood, 16°
MFL - medium flood, 24°
FL - flood, 30°
WF - wide flood, 45°
VWF - very wide flood, 60°
WW - wall wash, 90° x 60°

7 Color Temp
83 CRI:
27 - 2700K-83
30 - 3000K-83
35 - 3500K-83
40 - 4000K-83

8 Driver
ND - non-dimming driver
ELV - ELV dimming, 120V only

9 Options/Accessories
(not available for use with WW beam spread)
SN - snoot, 1" length, accepts up to 2 accessories
CB* - cross blade 1/2" deep, 16 cell, black finish
HEX* - hexcell louver (1/8" x 1/8")
SPR* - prismatic spread lens (use with NF or FL beam spreads only)
LSPR* - linear spread lens (do not use if SL beam spread is specified, not available for use with WW beam spread)
* Requires Snoot option



Note: See page 7 for Energy Star approved model numbers.

Contour[®] 4X4

Track Head



PROJECT:

TYPE:

Specifications

Application

Retail, Grocery and Commercial accent and display lighting

Construction

Extruded aluminum driver housing & heat sink
Stamped aluminum end plates
Formed steel wire cover

Optical

0-90° tilt, 360° rotation
Beam spreads: Narrow Flood, 16°; Medium Flood, 24°
Flood, 30°; Wide Flood, 45°; Very Wide Flood, 60°;
Wall Wash, 90°x 60° optic film

LED

Color Temp Options:
2700K, 3000K, 3500K, 4000K
CRI: 83 typ. (2700K, 3000K, 3500K, 4000K)
R9 Values: 11 (83 CRI)
Binning: 3 MacAdam (SDCM)
Life: 50,000+ hrs, > 70% of initial lumens at 50,000 hrs

Electrical

Wattage: 32
Electronic constant current LED driver, 120V/277V input
This product complies with IEEE C62.41 for surge endurance up to 2.5KV. Amerlux[®] recommends using additional surge protection with this unit (supplied by others), surge and over voltage damage is not covered under warranty.

Driver

Optional dimming driver available, Trailing Edge (ELV, Reverse Phase) only dimming to less than 10%, 120V only

Finish

Powder coat paint.
Standard colors: White Texture, Black Texttrue, Silver Texture
Consult factory for custom RAL powder coat finishes

Mounting (see below for options)

Track, canopy, c-clamp and busway.
See ordering information for all available options.

Note: Recommend track fixture mounting to horizontal surface mounted/pendant mounted track only

Certifications

Approved to UL standards as tested by CSA.
Intended for indoor use only.

Warranty

5 year limited warranty

Contour[®] 4X4

Track Head

PROJECT:

TYPE:

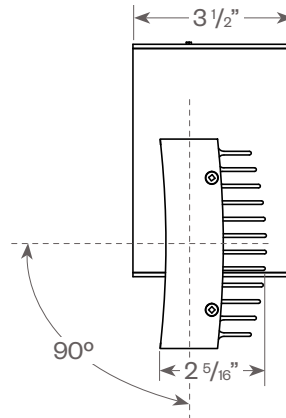
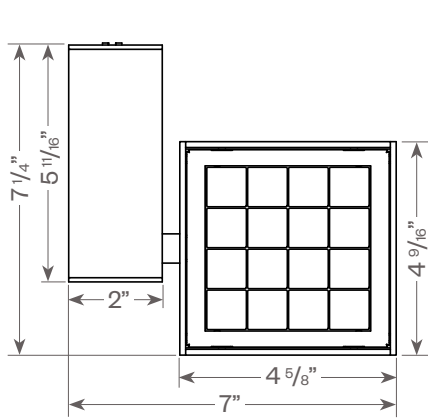

TEK/TN3/TN2

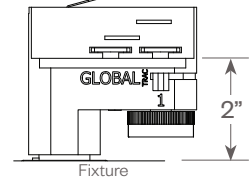

Canopy

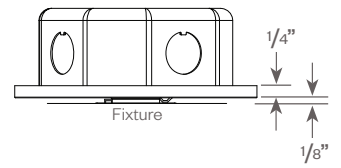

Accessories

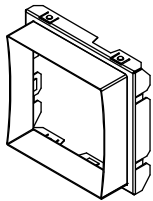

Snoot

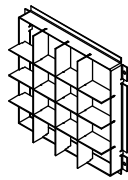

Cross Blade

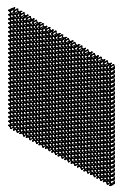

Hexcell Louver

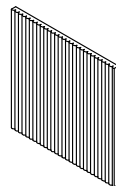

Linear Spread Lens

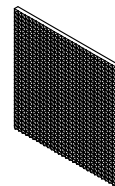

Prismatic Lens

Contour[®] 4X4

Track Head



PROJECT:

TYPE:

FIXTURE DATA: (Complete photometric data (.ies format) available upon request)

MULTIPLYING FACTORS: (Multiplying Factor is based on 2700K-83 120V IES file on website)

CCT:	2700K-83	3000K-83	3500K-83	4000K-83
Factor:	1.0	1.04	1.06	1.08

32W LED, 2700K

**NARROW FLOOD (NF) 16°
DISTRIBUTION
LTL # 227548**

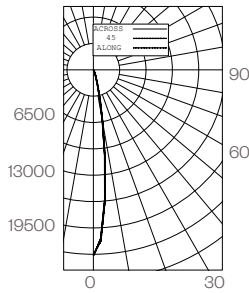

Candelas at Nadir	
Deg	Candela
0	22906
5	16340
15	2244
25	410
35	77
45	35

**MEDIUM FLOOD (MFL) 24°
DISTRIBUTION
LTL # 227550**

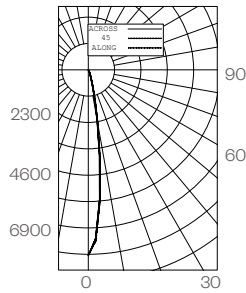

Candelas at Nadir	
Deg	Candela
0	8130
5	7411
15	3413
25	831
35	192
45	65

**FLOOD (FL) 30°
DISTRIBUTION
LTL # 227549**

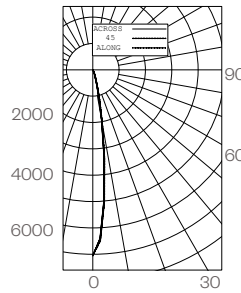

Candelas at Nadir	
Deg	Candela
0	6950
5	6511
15	2927
25	622
35	112
45	45

**WIDE FLOOD (WF) 45°
DISTRIBUTION
LTL # 227696**

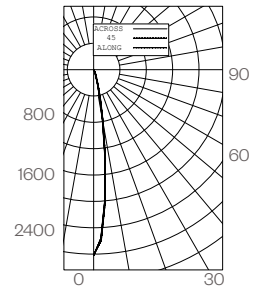

Candelas at Nadir	
Deg	Candela
0	2773
5	2688
15	2067
25	1154
35	453
45	132

APPLICATION DATA:

Notes and Definitions:

Beam spread is to 50% center beam candlepower (CBCP).

D=Distance to floor or wall.

FC=Footcandles on floor or wall at center beam aiming location.

L=Effective Visual Beam length in feet (50% of maximum footcandle level).

W=Effective Visual Beam width in feet (50% of maximum footcandle level).

CB=Distance across or down to center beam location.

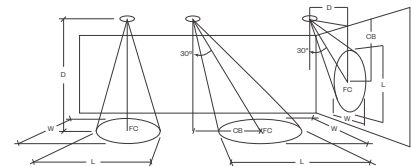

	0° Aiming Angle Horizontal Footcandles				30° Aiming Angle Horizontal Footcandles					30° Aiming Angle Vertical Footcandles					60° Aiming Angle Vertical Footcandles				
	D	FC	L	W	D	FC	L	W	CB	D	FC	L	W	CB	D	FC	L	W	CB
Narrow Flood	5.0'	565	1.7	1.6	5.0'	415	2.1	1.8	3.0	3.0'	278	3.0	1.8	5.0	3.0'	767	1.6	1.4	2.0
	7.5'	322	2.3	2.2	7.5'	232	2.8	2.5	4.0	4.0'	173	3.9	2.2	6.0	4.0'	563	2.0	1.5	5.0
	10.0'	200	2.9	2.8	10.0'	132	3.7	3.2	6.0	5.0'	119	4.6	2.7	8.0	5.0'	414	2.2	1.8	3.0
	12.5'	134	3.4	3.3	12.5'	91	4.4	3.8	7.0	6.0'	85	5.5	3.1	9.0	6.0'	300	2.5	2.1	3.0
Medium Flood	5.0'	293	2.5	2.4	5.0'	197	3.1	2.7	3.0	3.0'	154	3.6	2.3	4.0	3.0'	449	2.1	1.7	2.0
	7.5'	141	3.4	3.3	7.5'	98	4.3	3.7	4.0	4.0'	90	4.7	3.0	5.0	4.0'	316	2.4	2.1	2.0
	10.0'	81	4.6	4.5	10.0'	56	5.7	4.9	5.0	5.0'	58	5.8	3.7	7.0	5.0'	198	3.1	2.7	3.0
	12.5'	52	5.7	5.5	12.5'	36	7.1	6.2	6.0	6.0'	42	7.0	4.4	8.0	6.0'	149	3.5	3.0	3.0
Flood	5.0'	253	2.5	2.4	5.0'	170	3.1	2.7	3.0	3.0'	137	3.5	2.4	4.0	3.0'	390	2.1	1.8	2.0
	7.5'	121	3.5	3.4	7.5'	85	4.4	3.7	4.0	4.0'	81	4.5	3.0	5.0	4.0'	274	2.4	2.2	2.0
	10.0'	70	4.7	4.5	10.0'	49	5.7	4.9	5.0	5.0'	52	5.6	3.8	6.0	5.0'	171	3.2	2.7	3.0
	12.5'	45	5.8	5.5	12.5'	32	7.2	6.1	6.0	6.0'	37	6.8	4.4	8.0	6.0'	130	3.6	3.1	3.0
Wide Flood	5.0'	113	3.6	3.5	5.0'	83	4.1	3.7	2.0	3.0'	80	3.8	3.1	3.0	3.0'	198	2.7	2.5	1.0
	7.5'	51	5.3	5.1	7.5'	38	6.1	5.5	3.0	4.0'	47	4.8	3.9	4.0	4.0'	128	3.3	3.2	2.0
	10.0'	29	7.1	6.8	10.0'	22	8.0	7.3	4.0	5.0'	30	6.0	4.9	5.0	5.0'	85	4.1	3.7	2.0
	12.5'	18	8.9	8.5	12.5'	14	10.3	9.4	5.0	6.0'	21	7.3	6.0	6.0	6.0'	57	5.0	4.6	2.0

Contour[®] 4X4

Track Head



PROJECT:

TYPE:

FIXTURE DATA: (Complete photometric data (.ies format) available upon request)

MULTIPLYING FACTORS:

CCT:	2700K-83	3000K-83	3500K-83	4000K-83
Factor:	1.0	1.04	1.06	1.08

Contour 4x4 Vertical Wall Wash 32W, 2700K
Source: 16 white LEDs Lumens: 2082
Recessed

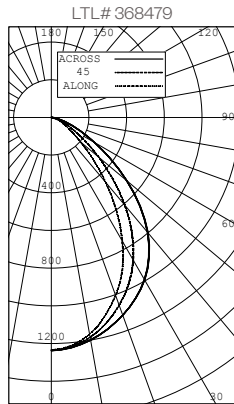

ZONAL LUMEN SUMMARY

Zone	Lumens	%Fixt
0-30	880	42.27
0-40	1346	64.64
0-60	1932	92.78
0-90	2082	100.0
40-90	736	35.36
60-90	150	7.22
90-180	0	0.0
0-180/2082	100.0	

Efficacy (lpw) = 60.7%

APPLICATION DATA:

Footcandles are average and rounded off.
 Data for multiple units are based on a minimum of five units.

Footcandles on Wall

3' off wall, 3' o.c., 30° tilt

Distance from Fixture	Footcandle Distribution								
	1'	2'	3'	4'	5'	6'	7'	8'	9'
1'	61	60	61	61	60	60	60	60	60
2'	87	87	88	89	88	87	87	87	87
3'	83	84	85	85	85	84	83	83	83
4'	65	67	67	68	67	66	65	65	65
5'	49	50	51	51	51	50	49	49	49
6'	36	37	38	38	38	37	36	36	36
7'	28	29	29	29	29	29	28	28	28
8'	22	22	23	23	23	22	22	22	22
9'	18	18	19	19	19	18	18	18	18

4' off wall, 4' o.c., 30° tilt

Distance from Fixture	Footcandle Distribution									
	1'	2'	3'	4'	5'	6'	7'	8'	9'	10'
1'	31	31	30	31	31	30	30	30	31	31
2'	48	47	47	47	48	47	47	47	47	47
3'	54	54	54	54	54	54	54	54	54	54
4'	50	50	50	50	50	49	49	49	49	49
5'	42	42	42	43	43	42	42	42	41	41
6'	34	35	35	35	35	35	35	35	34	34
7'	28	29	29	29	29	29	28	28	28	28
8'	23	24	24	24	24	24	23	23	23	23
9'	20	20	20	21	20	20	20	20	20	20

4' off wall, 5' o.c., 30° tilt

Distance from Fixture	Footcandle Distribution											
	1'	2'	3'	4'	5'	6'	7'	8'	9'	10'	11'	12'
1'	25	24	22	23	24	25	24	23	22	24	24	25
2'	38	37	35	35	37	38	37	35	35	37	38	38
3'	42	42	41	41	42	42	41	41	41	42	42	42
4'	39	39	39	39	39	40	40	39	39	39	39	39
5'	33	34	34	34	34	34	34	34	33	34	34	34
6'	28	28	28	28	28	28	28	28	28	28	28	28
7'	22	23	23	23	23	23	23	23	23	23	22	22
8'	18	19	19	19	19	19	19	19	19	19	19	19
9'	16	16	16	16	16	16	16	16	16	16	16	16

PROJECT:

TYPE:

ENERGY STAR APPROVED MODEL NUMBERS:



Certificate of

Conformance

Energy Efficiency Certification

UL conducted an independent evaluation on behalf of:

AMERLUX L L C
23 DANIEL RD, FAIRFIELD, NJ 07004-2527

for the following products:

Directional Luminaires

Brand: Amerlux

Model: See Appendix A

This product meets all of the necessary qualifications pursuant to:

ENERGY STAR[®]: Program Requirements for Luminaires, Version 2.0

2017-02-27

Certification Date

N/A

Certification Revision Date

[Signature]

Issued by

11628405

UL Product Number

00-V5-F0418, Version 3.0, This is to certify that representative samples of the Certified Product(s) listed above have been investigated by UL to the Standard(s) indicated on this certificate, in accordance with the UL Global Services Agreement and the EEC Terms & Conditions ("Agreement"). The Certificate Holder is entitled to use the UL Energy Verified Mark for the Certified Product(s) listed on the certificate and manufactured at the production site(s) covered by the UL Test Report, in accordance with the terms of the Agreement. This Certificate shall remain valid unless a Standard identified on this Certificate is amended or withdrawn prior to that date or these is a non-compliance with the Agreement.

Appendix A

Model Name	Model Number
Contour	CNTR*44-A17-32-**-***-###-***-30-**
	CNTR*44-A17-32-**-***-###-***-35-**
	CNTR*44-A17-32-**-***-###-***-40-**