

Rook® 350

3.5" Round Wall Mount

Direct or Indirect

Dim-To-Warm



Features

The contemporary Rook 350 Direct or Indirect Wall Mount is universal allowing the fixture to be mounted as a Direct or Indirect luminaire just by flipping its orientation. Rook 350 has the same optical performance as our Hornet 3.5" Downlights. With only a 3.5" aperture the Rook 350 can be used to add visual interest to walls or columns. The Rook 350 cylinder family is available as a pendant, surface or wall mount allowing it to fit in any retail, hospitality or commercial environment. Our Dim-To-Warm option allows designers to simulate the familiar glow and dimming of incandescent lamps. By shifting to a lower Kelvin temperature, as you dim the lights, Dim-To-Warm can tap into the powerful mediums of light and color to enhance the experience and well-being.

Product Overview

| | |
|---------------|--|
| Type: | Round Wall Mount, Direct or Indirect (Field changeable to indirect orientation) |
| Wattage: | 13W |
| Lumen Output: | 672 lm (RK350WR); 822 lm (RK350WRL) |
| Color Temp: | 3000K to 1800K |
| CRI: | 95 typ. |
| Dimming: | TRIAC & ELV (120V/277V) - 5% Dim 0-10V (120V/277V) - 1% Dim |

Direct



Wall Mount Canopy Wall Mount Conduit Canopy Wall Mount



Remote Wall Mount Remote Canopy Wall Mount Remote Conduit Canopy Wall Mount

PROJECT:

Indirect



Wall Mount Canopy Wall Mount Conduit Canopy Wall Mount



Remote Wall Mount Remote Canopy Wall Mount Remote Conduit Canopy Wall Mount

TYPE:

Performance Chart

| Watts | Delivered Lumens | LPW | Color Temp |
|-----------------|------------------|------|------------|
| RK350WR | | | |
| 13 | 672 | 51.7 | 3000K-95 |
| RK350WRL | | | |
| 13 | 822 | 63.2 | 3000K-83 |

Electrical Data

| | 13W | |
|------|--------------|------|
| | System Watts | Amps |
| 120V | 13 | 0.11 |
| 277V | 13 | 0.05 |

Electronic constant current LED driver

Dim-To-Warm CCT Curve

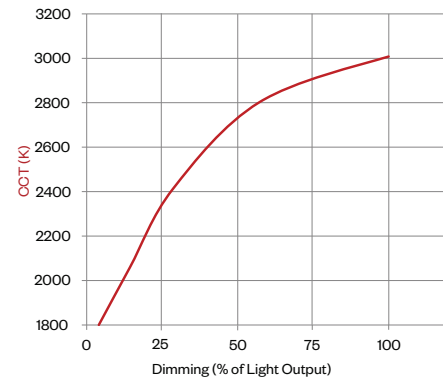

Rook® 350

3.5" Round Wall Mount, Direct or Indirect, Dim-To-Warm



PROJECT:

TYPE:

Ordering Information

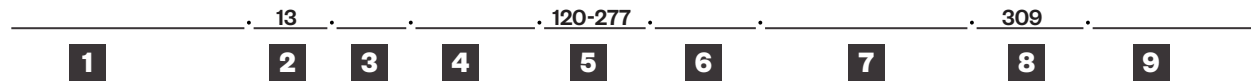

Open Unit

- 1** Model
RK350WR-U-DTW
RK350WR-U-DTW-REMOTE (remote driver)
- 2** Wattage
13
- 3** Housing Finish
MW - matte white
MB - matte black
SLV - matte silver
- 4** Mounting* (matches housing finish)
WM - wall mount
CWM - canopy wall mount
CDWM - conduit canopy wall mount
- 5** Voltage
120-277
- 6** Trim Finish
MW - matte white
MB - matte black
SLV - matte silver
- 7** Beam Spread
VNF - narrow flood, 18°
MFL - medium flood, 24°
FL - flood, 28°
WF - wide flood, 45°
- 8** Color Temp
95 CRI
309 - 3000K-95
- 9** Driver
LE/TE - TRIAC/ELV dimming, 5% dim
0-10V - 0-10V dimming; 1% dim

Lensed Unit

- 1** Model
RK350WRL-U-DTW (Lensed)
RK350WRL-U-DTW-REMOTE (Lensed, remote driver)
- 2** Wattage
13
- 3** Housing Finish
MW - matte white
MB - matte black
SLV - matte silver
- 4** Mounting* (matches housing finish)
WM - wall mount
CWM - canopy wall mount
CDWM - conduit canopy wall mount
- 5** Voltage
120-277
- 6** Trim Finish
MW - matte white
MB - matte black
SLV - matte silver
- 7** Beam Spread
30SOL - 30° solite lens
40SOL - 40° solite lens
65SOL - 65° solite lens
- 8** Color Temp
95 CRI
309 - 3000K-95
- 9** Driver
LE/TE - TRIAC/ELV dimming, 5% dim
0-10V - 0-10V dimming; 1% dim

* Note: Indirect Mounting Kit provided with all fixtures to mount fixture for uplighting.

Rook® 350

3.5" Round Wall Mount, Direct or Indirect, Dim-To-Warm



PROJECT:

TYPE:

Specifications

Application

Commercial, hospitality and retail ambient/accent wall mounted fixtures.

Construction

Extruded aluminum pendant housing
Die-cast trim
Extruded aluminum heat sink
Fixture shipped with dust cover for use when fixture is used as indirect

Optical

RK350WR Beam Spreads:
Very Narrow Flood, 18°; Medium Flood, 24°; Flood, 35°; Wide Flood, 44°
Linear Spread, 60° x 10°
RK350WRL Beam Spreads:
Solite Lens for maximum efficacy and a visually quieter aperture. 30°, 40° & 65° beam spread options. Visually best with SLV reflector finish.

LED

Color Temp Options: 3000K (Dims to 1800K)
CRI: 95 typ. (± 3 across dimming range)
R9 Values: 85
Binning: 3 MacAdam (SDCM)
Life: 50,000+ hrs, > 70% of initial lumens at 50,000 hrs

Electrical

Wattage: 13W
Electronic constant current LED driver, 120V-277V input
This product complies with IEEE C62.41 for surge endurance up to 2.5KV. Amerlux® recommends using additional surge protection with this unit (supplied by others), surge and over voltage damage is not covered under warranty.
For emergency: Remote EM inverter or emergency circuit by others
Remote Driver Wiring: Driver is supplied installed in remote driver box, (one driver per box), with 5' of low voltage plenum rated cable. Amerlux recommends a maximum of 15' between the fixture and the remote driver box. Consult factory with job specific electrical spec if more than 15' is required.

Drivers

LE/TE - Leading Edge, TRIAC, forward phase/Trailing Edge, ELV, reverse phase
0-10V also available

Finish

Powder coat paint
Consult factory for custom finishes

Mounting

Wall mounted (direct orientation), see options on pg 4

Note: For Indirect orientation, use the INDIRECT MOUNTING

KIT

- Flip the mounting bracket
- Mount the Dust cover provided in kit
- Mounting bracket & design symmetrically centered

Certifications

CSA tested to UL standards
Indoor use only
Damp location

Warranty

5 year limited warranty

Rook® 350

3.5" Round Wall Mount, Direct or Indirect, Dim-To-Warm



PROJECT:

TYPE:

Wall Mount

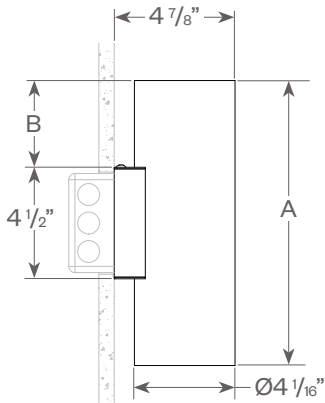

Wall Mount Fixtures are capable of being flipped to indirect. Dust cover provided with fixture for indirect orientation.

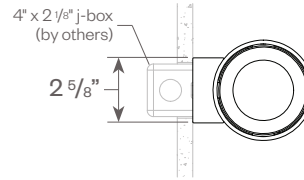

| Fixture | A | B |
|---------------------|---------|--------|
| RK350W(R/RL) | 11 1/2" | 3 1/2" |
| RK350W(R/RL)-REMOTE | 6 1/2" | 1" |

Canopy Wall Mount

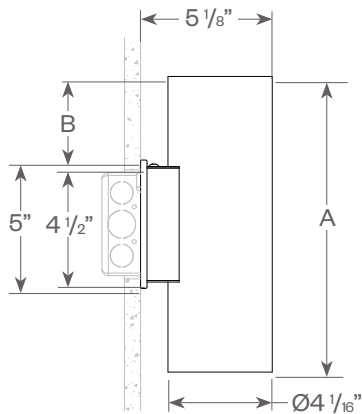

Canopy Wall Mount Fixtures are capable of being flipped to indirect. Dust cover provided with fixture for indirect orientation.

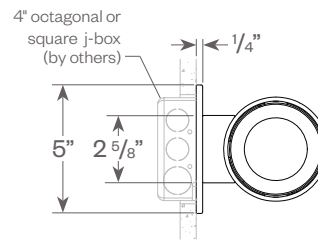

| Fixture | A | B |
|---------------------|---------|--------|
| RK350W(R/RL) | 11 1/2" | 3 1/4" |
| RK350W(R/RL)-REMOTE | 6 1/2" | 3/4" |

Conduit Canopy Wall Mount

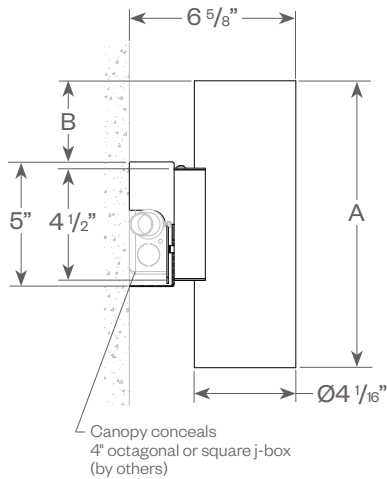

Canopy Wall Mount Fixtures are capable of being flipped to indirect. Dust cover provided with fixture for indirect orientation.

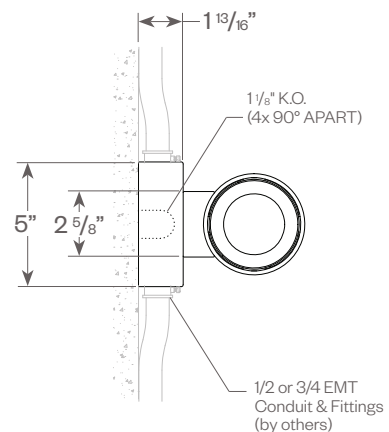

| Fixture | A | B |
|---------------------|---------|--------|
| RK350W(R/RL) | 11 1/2" | 3 1/4" |
| RK350W(R/RL)-REMOTE | 6 1/2" | 3/4" |

Remote Driver Box

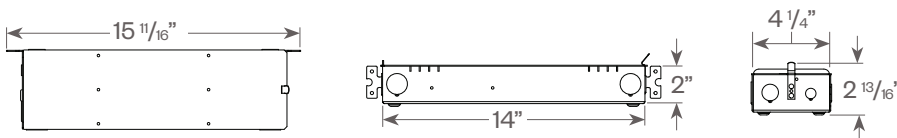

Drivers are supplied installed in remote driver box, with 15' of low voltage plenum rated cable. Amerlux recommends a maximum of 15' between the fixture and the remote driver box. Consult factory with job specific electrical spec if more than 15' is required.

Rook® 350

3.5" Round Wall Mount, Direct or Indirect, Dim-To-Warm



PROJECT:

TYPE:

RK350WR

FIXTURE DATA: (Complete photometric data (.ies format) available upon request)

13W LED, 3000K-95

Very Narrow Flood (VNF)
Distribution, 18°
LTL #11919582.12
Lumens: 672

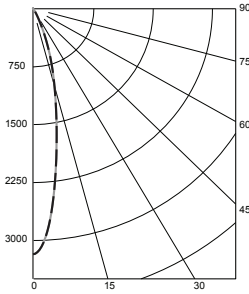

Candelas at Nadir

| Deg | Candela |
|-----|---------|
| 0 | 3179 |
| 5 | 2638 |
| 15 | 1030 |
| 25 | 252 |
| 35 | 43 |
| 45 | 10 |

Medium Flood (MFL)
Distribution, 25°
LTL #11919582.13
Lumens: 609

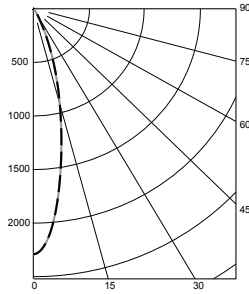

Candelas at Nadir

| Deg | Candela |
|-----|---------|
| 0 | 2291 |
| 5 | 2024 |
| 15 | 942 |
| 25 | 267 |
| 35 | 50 |
| 45 | 11 |

Flood (FL)
Distribution, 35°
LTL # 11919582.14
Lumens: 582

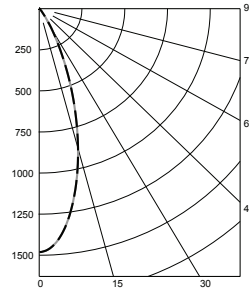

Candelas at Nadir

| Deg | Candela |
|-----|---------|
| 0 | 1481 |
| 5 | 1395 |
| 15 | 882 |
| 25 | 331 |
| 35 | 63 |
| 45 | 13 |

Wide Flood (WF)
Distribution, 45°
LTL # 11919582.15
Lumens: 540

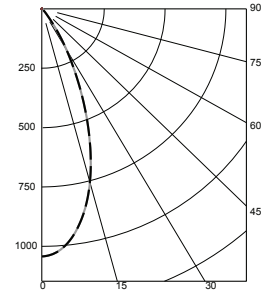

Candelas at Nadir

| Deg | Candela |
|-----|---------|
| 0 | 1042 |
| 5 | 1007 |
| 15 | 751 |
| 25 | 359 |
| 35 | 85 |
| 45 | 15 |

Application Data:

0° Aiming Angle Horizontal Footcandles

| | D | FC | L | W |
|--------------------------|-------|-----|-----|-----|
| Very Narrow Flood | 5.0' | 122 | 1.8 | 1.8 |
| | 7.5' | 55 | 2.9 | 2.9 |
| | 10.0' | 31 | 3.7 | 3.7 |
| | 12.5' | 20 | 4.6 | 4.6 |
| Medium Flood | 5.0' | 88 | 2.3 | 2.3 |
| | 7.5' | 40 | 3.3 | 3.3 |
| | 10.0' | 23 | 4.4 | 4.4 |
| | 12.5' | 15 | 5.5 | 5.5 |
| Flood | 5.0' | 57 | 3.0 | 3.0 |
| | 7.5' | 26 | 4.4 | 4.4 |
| | 10.0' | 15 | 5.7 | 5.7 |
| | 12.5' | 9 | 7.2 | 7.2 |
| Wide Flood | 5.0' | 40 | 3.4 | 3.4 |
| | 7.5' | 18 | 5.1 | 5.1 |
| | 10.0' | 10 | 6.9 | 6.9 |
| | 12.5' | 7 | 8.5 | 8.5 |

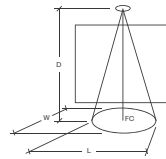

Notes and Definitions:

- Beam spread is to 50% center beam candlepower (CBCP).
- D**=Distance to floor or wall.
- FC**=Footcandles on floor or wall at center beam aiming location.
- L**=Effective Visual Beam length in feet (50% of maximum footcandle level).
- W**=Effective Visual Beam width in feet (50% of maximum footcandle level).
- CB**=Distance across or down to center beam location.

Rook® 350

3.5" Round Wall Mount, Direct or Indirect, Dim-To-Warm



PROJECT:

TYPE:

RK350WRL

FIXTURE DATA: (Complete photometric data (.ies format) available upon request)

13W LED, 3000K-95

30° Solite Lens
LTL # 11919582.24
Lumens: 815

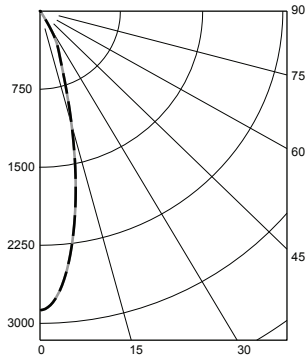

Candelas at Nadir

| Deg | Candela |
|-----|---------|
| 0 | 2874 |
| 5 | 2591 |
| 15 | 1168 |
| 25 | 411 |
| 35 | 41 |
| 45 | 18 |

40° Solite Lens
LTL # 11919582.25
Lumens: 822

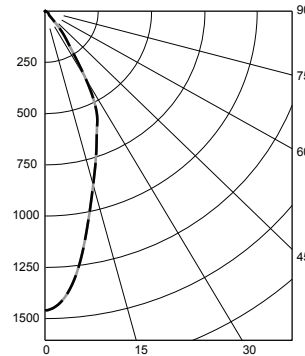

Candelas at Nadir

| Deg | Candela |
|-----|---------|
| 0 | 1460 |
| 5 | 1358 |
| 15 | 875 |
| 25 | 582 |
| 35 | 188 |
| 45 | 29 |

65° Solite Lens
LTL # 11919582.26
Lumens: 818

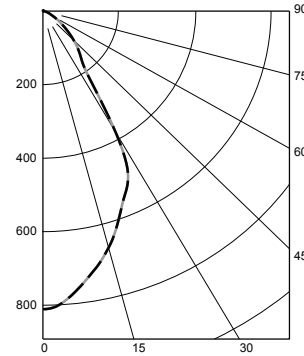

Candelas at Nadir

| Deg | Candela |
|-----|---------|
| 0 | 811 |
| 5 | 783 |
| 15 | 667 |
| 25 | 526 |
| 35 | 195 |
| 45 | 118 |

Application Data:

Notes and Definitions:

Beam spread is to 50% center beam candlepower (CBCP).

D=Distance to floor or wall.

FC=Footcandles on floor or wall at center beam aiming location.

L=Effective Visual Beam length in feet (50% of maximum footcandle level).

W=Effective Visual Beam width in feet (50% of maximum footcandle level).

CB=Distance across or down to center beam location.

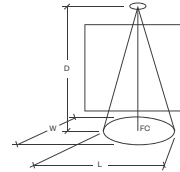

**0° Aiming Angle
Horizontal
Footcandles**

| | D | FC | L | W |
|------------------------|-------|-----|------|------|
| 30° Solite Lens | 5.0' | 115 | 2.3 | 2.3 |
| | 7.5' | 51 | 3.3 | 3.3 |
| | 10.0' | 29 | 4.5 | 4.5 |
| | 12.5' | 19 | 5.6 | 5.6 |
| 50° Solite Lens | 5.0' | 59 | 3.1 | 3.1 |
| | 7.5' | 26 | 4.5 | 4.5 |
| | 10.0' | 15 | 5.9 | 5.9 |
| | 12.5' | 10 | 7.5 | 7.5 |
| 65° Solite Lens | 5.0' | 33 | 4.4 | 4.4 |
| | 7.5' | 15 | 6.7 | 6.7 |
| | 10.0' | 8 | 9.1 | 9.1 |
| | 12.5' | 5 | 11.7 | 11.7 |

Rook® 350

3.5" Round Wall Mount, Direct or Indirect, Dim-To-Warm



PROJECT:

TYPE:

DIMMING COMPATIBILITY:

Amerlux® Rook fixtures are compatible with all major dimming protocols prevalent in the United States. Please see below for general compatibilities and wiring diagrams. Amerlux recommends testing your unique dimming configuration as the exact full configuration (Dimmer, Fixture Quantity, Voltage, etc) may affect dimming performance.

--- NOTE: INFORMATION BELOW IS FOR WIRED DIMMERS ONLY. FOR WIRELESS DIMMERS, CONSULT FACTORY ---

TRIAC (Forward Phase) DIMMING (Standard)

Utilizes "Standard" incandescent dimmers that are in wide use in installations across the US. Best for retrofit applications where TRIAC dimmers are installed.

Notes:

- 120V or 277V*
- Dims down to less than 5% light output (most cases)
- Consult Dimming manufacturer for installation instructions - DO NOT SHARE NEUTRALS!
- Must meet dimmer Minimum Load Requirements per dimming manufacturer

TRIAC Wiring Diagram

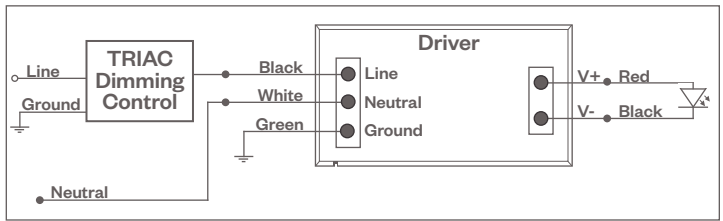

Compatible Dimmers†:

| Wall Box (Incandescent Style, Wattage as required) | | Central System |
|--|------------------|----------------------|
| Lutron "Diva" | Lutron "Vareo" | Lutron "GP" Panel |
| Lutron "Nova-T" | Lutron "Skylark" | Lutron Grafik Eye QS |
| Lutron "Maestro" | | |

ELV - Electronic Low Voltage (Reverse Phase) DIMMING (Standard)

Utilizes specialized "ELV" dimmers.

Notes:

- 120V or 277V*
- Dims down to less than 5% light output (most cases)
- Consult Dimming manufacturer for installation instructions - DO NOT SHARE NEUTRALS!
- Must meet dimmer Minimum Load Requirements

ELV Wiring Diagram

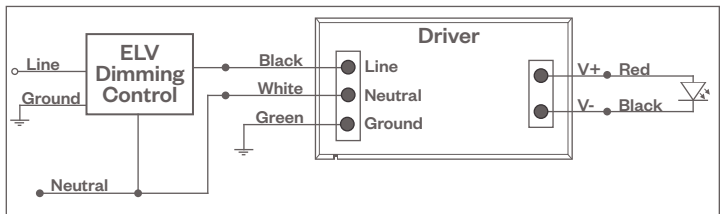

Compatible Dimmers†:

| Wall Box (ELV Style) | | Central System |
|----------------------|--------------------|---|
| Lutron "Diva" | Leviton "Surslide" | Lutron "GP" Panel with PHPM-PA Interface |
| Lutron "Nova-T" | Leviton "Vizio" | Lutron Grafik Eye QS with PHPM-PA Interface |
| Lutron "Maestro" | | |
| Lutron "Vareo" | | |
| Lutron "Skylark" | | |

Notes:

- * Driver is 277V dimmable with appropriate dimmer (by others). All provided wiring diagrams show 120V wiring colors and method. Please refer to 277V dimmer installation instructions for 277V wiring diagrams.
- † The absence of a dimmer from the lists above does not imply incompatibility. Please consult factory for compatibility inquiries.

Rook® 350

3.5" Round Wall Mount, Direct or Indirect, Dim-To-Warm



PROJECT:

TYPE:

DIMMING COMPATIBILITY:

Amerlux® Rook fixtures are compatible with all major dimming protocols prevalent in the United States. Please see below for general compatibilities and wiring diagrams. Amerlux recommends testing your unique dimming configuration as the exact full configuration (Dimmer, Fixture Quantity, Voltage, etc) may affect dimming performance.

--- NOTE: INFORMATION BELOW IS FOR WIRED DIMMERS ONLY. FOR WIRELESS DIMMERS, CONSULT FACTORY ---

0-10V - DIMMING (-0-10V Option)

Integrates into a variety of building management and daylighting controls

Notes:

- 120V or 277V*
- Dims down to 1% light output
- Requires interface to turn off power to driver
- Consult Dimming manufacturer for installation instructions - DO NOT SHARE NEUTRALS!

0-10V Wiring Diagram

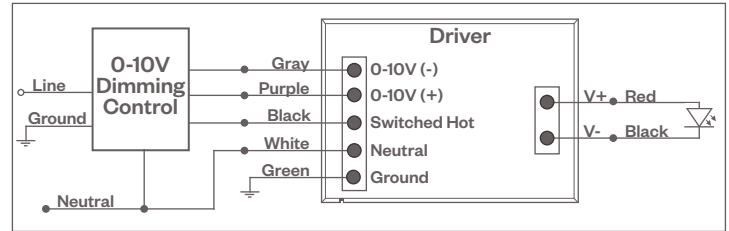

Compatible Dimmers*:

Wall Box

Lutron "Diva" - DVTV with PP-120H Interface

Leviton Renoir II 0-10V

Central System

Lutron Grafik Eye with GRX-TVI Interface