

**WARNING - RISK OF FIRE AND ELECTRICAL SHOCK. FIXTURE MUST BE INSTALLED BY A QUALIFIED ELECTRICIAN ONLY. FIXTURE IS INTENDED FOR INSTALLATION IN ACCORDANCE WITH THE NATIONAL ELECTRICAL CODE, LOCAL AND FEDERAL SPECIFICATIONS. DISCONNECT POWER AT ELECTRICAL PANEL BEFORE SERVICING.
RETAIN THESE INSTRUCTIONS FOR MAINTENANCE REFERENCE.**

Supplied by Amerlux: - pre-drilled mounting points @ 5" & 6" from ends of fixture

Pre-drilled suspension points for fixtures are:

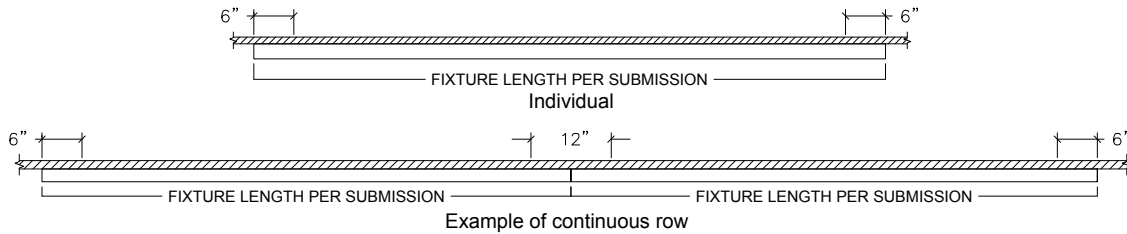

Refer to general contractor/ electrician layout for proper location of mounting points/ locations for feed conduits.

1. Install fixture accordingly.
Route fixture **LOW VOLTAGE CABLE** to remote Driver Box location.
Note: 1 remote Driver Box per fixture section

1A. Individual and Beginning of Run Install*-

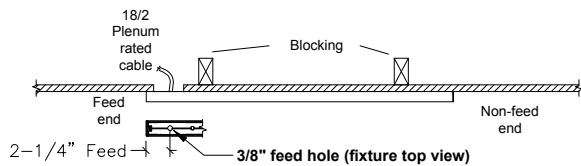

***Note - Fixture mounting points are pre-drilled at 5" and 6" in from ends of fixtures. If alternate mounting points are req'd, drill & mount as necessary as shown on 1B.**

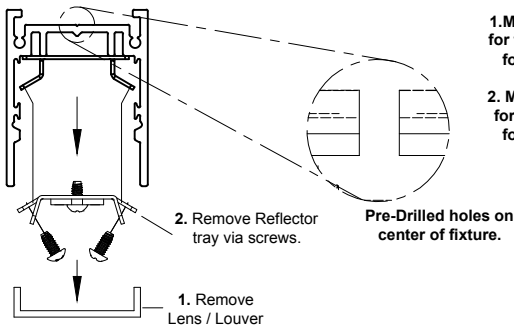
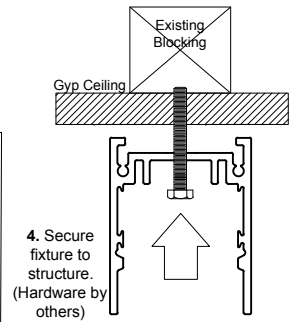

NOTE:
1. Mounting hole location for fixtures under 23" are found 5" in from both ends.
2. Mounting hole location for fixtures over 23" are found 6" in from both ends.

5. Re-assemble Fixture (IND Only. For Runs, continue to other side)

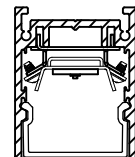

1B. Hang Continuing Fixtures - After the BOR has been installed:

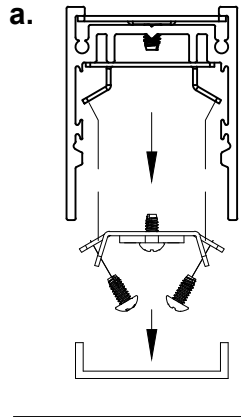

Prep Fixture for Mounting - Remove reflector tray assembly. Drill holes in appropriate mounting locations if necessary (per contractor)*

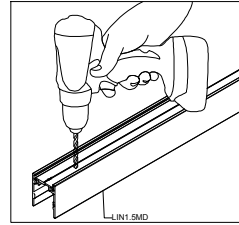

b. Join Fixtures Together
 - Use the aligning pins to engage then secure to ceiling via mounting hardware (By others)

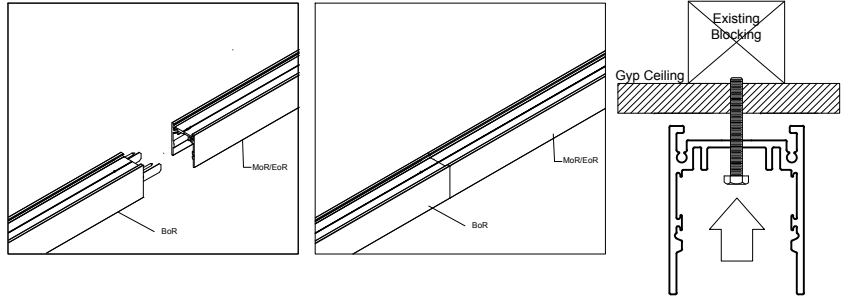
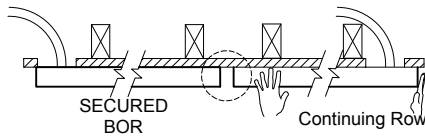

C. Re-Assembly and Power - Install BoR reflector tray and lens. Power is not carried over from one fixture to the other. Each fixture has a power feed and remote driver.

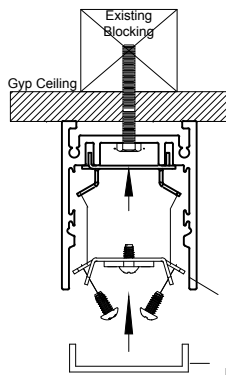
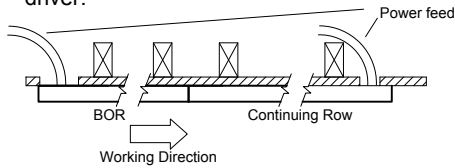

Re-Assembled Section View

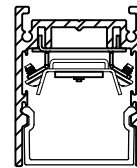

2. INSTALL REMOTE DRIVER BOX IN ACCESSIBLE LOCATION

TOTAL CABLE LENGTH FROM FIXTURE TO DRIVER CANNOT EXCEED 15' (INSTALLING CONTRACTOR TO CUT/STRIP PROVIDED LEADS TO MEET THIS CRITERIA) CONTACT FACTORY FOR LONGER DISTANCES

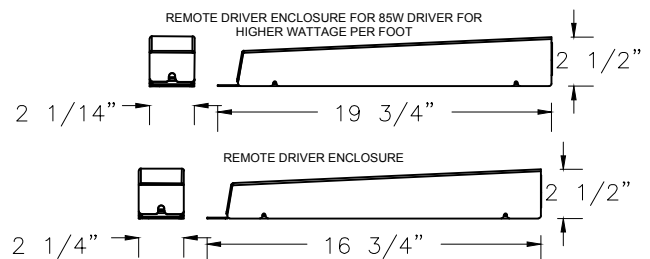
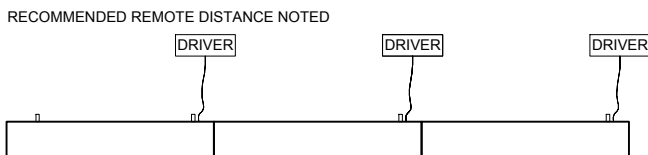

NOTE: LARGER DRIVERS MAY HAVE LARGER ENCLOSURE

18/2 PLENUM RATED CORD, STANDARD 10' OFF DRIVER BOX.

18/2 PLENUM RATED CORD, STANDARD 10' OFF FIXTURE.

TOTAL FIXTURE LENGTH PER DRIVER:

5W MIN: 2'-0"
 MAX: 8'-0"
 10W MIN: 2'-0"
 MAX: 8'-0"

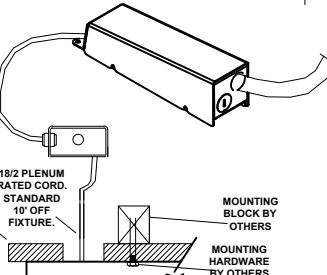

TOTAL LOW VOLTAGE CABLE LENGTH FROM DRIVER TO FIXTURE CANNOT EXCEED 15' (INSTALLING CONTRACTOR TO CUT/STRIP PROVIDED LEADS TO MEET THIS CRITERIA)

3. MAKE LED ELECTRICAL CONNECTIONS 18/2 PLENUM CABLE TO LED DRIVER

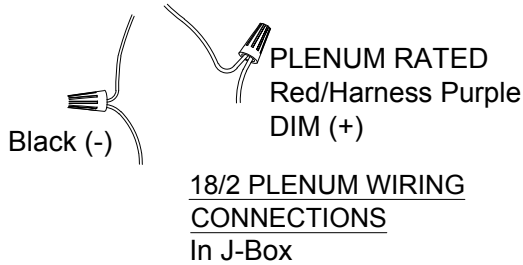

4. MAKE POWER ELECTRICAL CONNECTIONS BLACK, WHITE, GREEN, PURPLE(DIM+), GRAY(DIM-)

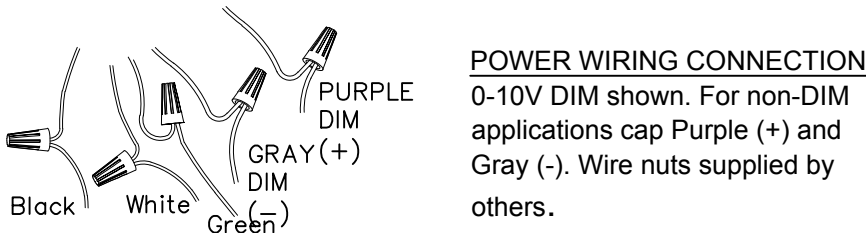

MAKE SURE TO DISCONNECT ALL ELECTRICAL CONNECTIONS BEFORE SERVICING.

WARNING: Electrostatic and polarity sensitive device. Use caution while handling and wiring.

1.) LED Fixture:

Consult Amerlux for LED maintenance.

2.) LED Replacement:

For LED board replacement reference 689-0500 Instruction Sheet.

3.) Driver maintenance:

Drivers are located in the remote enclosure. For **programmable** driver replacement please specify: **Manufacturer, Model No.** and **Current Setting** (mA). For drivers with **external** resistors, keep driver resistor value during driver maintenance or replacement.

See 710-0134 Wiring Schematic for more details.

