

Varieta

Single Array LED Flood Light

FLC1/BLK



Features

The Amerlux Varieta flood luminaire employs solid state technology and precision engineering to provide LED solutions for exterior signage, wall washing, and landscape layouts. All components are encapsulated inside a single attractive enclosure designed for superior performance in weather resistant applications. Offered in a choice of finishes, and color temperatures, three mounting options and glare shield are also available.

Product Overview

Wattage:	24W
Lumen Output:	2,500 lm
Color Temp:	3,000K / 4,000K / 5,000K
Dimming:	0-10 volt

PROJECT:

TYPE:

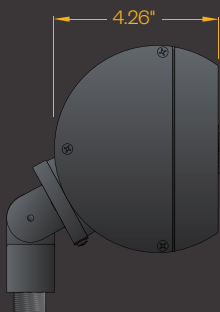
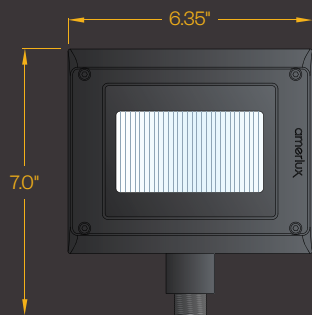

Construction:

- Die-Cast aluminum faceplate
- Extruded aluminum housing
- IP67 sealed optical module

Mounting:

- Cast aluminum pivot
- 180° tilt
- 360° rotation

Electrical:

- Integral driver
- Input voltage 120v-277v auto-sensing
- Power consumption 24W
- 1/2" NPT wire entry
- Dimming is standard

Accessories:

EGS -Ext Glare Shield

Mounting Accessories:

- GSP17** -Ground Stake
- PMBS-2-18** -Pole Mount
- WMS14** -Wall Mount

Optics:

- Lumen maintenance: 70% @ 50,000 hours
- Lens provides NEMA 7x6 distribution pattern
- Single COB LED is available in various color temperatures

Ambient Operating Range:

-30°C to 40°C

Weight:

5 lbs

EPA:

0.25

ETL listed, suitable for wet locations.

Finish:

Premium quality thermoset polyester powdercoat for a durable finish in the following:

BLK -Satin Black

CLB -Classic Bronze

GRN -Green

TBK -Textured Black

WHT -White



Varieta

Single Array LED Flood Light



PROJECT:

TYPE:

Ordering Information



1 Model
FLC1

2 Color Temp
30 - 3,000K
40 - 4,000K
50 - 5,000K

3 Finish
BLK -Satin Black
CLB -Classic Bronze
GRN -Green
TBK - Textures Black
WHT - White
CSTM -Custom

4 Accessories
EGS - External Glare Shield

Mounting Accessories Ordering Information

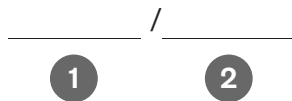

1 Mounting Accessories
GSP17 - Ground Stake (black polycarbonate)
PMBS-2-18 - Pole Mount (specify finish)
WMS14 - Wall Mount (specify finish)

2 Finish
BLK -Satin Black
CLB -Classic Bronze
GRN -Green
CSTM -Custom

Varieta

Single Array LED Flood Light



PROJECT:

TYPE:

Accessories:



External Glare Shield
EGS

Mounting:

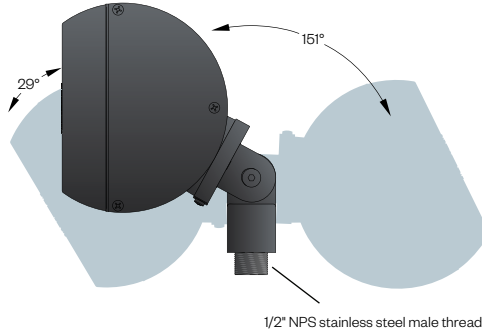

1/2" NPS stainless steel male threads

Optical Performance:

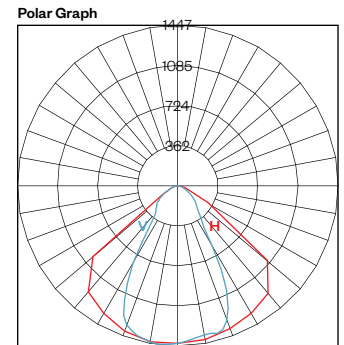

Maximum Candela = 1447
Located At Horizontal Angle = -10, Vertical Angle = -5
H - Horizontal Axial Candela
V - Vertical Axial Candela

Mounting Accessories:

Order Separately

Wall Mount

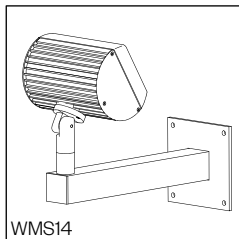

WMS14

Mounting hardware not included

Pole Mount

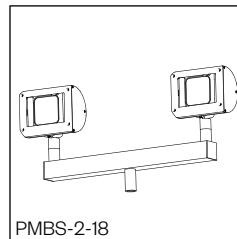

PMBS-2-18

Ground Spike

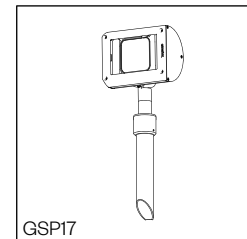

GSP17

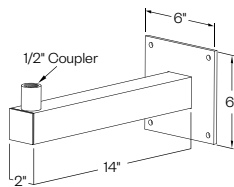

EPA: 0.208

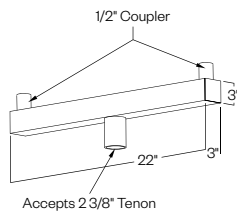

EPA: 0.513

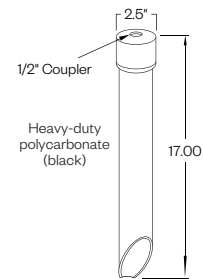

Performance Chart

CCT	CRI	Approximate Lumens	Total Efficacy
30 (3,000K)	80	2,100	87 Lm/W
40 (4,000K)	80	2,500	104 Lm/W
50 (5,000K)	80	2,500	104 Lm/W