

GLOBAL TRACK SINGLE CIRCUIT 120V

GES
1 CIR 120V

APPLICATIONS:

Power supply for Amerlux® track lighting fixtures

CONSTRUCTION:

Architectural grade, extruded aluminum housing
Milled grounding bar provides continuous ground contact
Continuously crimped conductor ensures mechanical strength and electrical reliability
Black, white or gray

MOUNTING:

T-Grid, aircraft cable or stem mount options
Stem mounting is field cuttable
Max. 4' O.C. suspension points

LABELING:



PROJECT:

TYPE:

GES Track Components

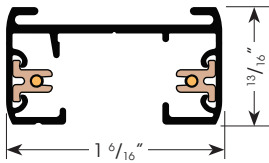

Dead End
GES41



T-Bar Feed Kit
GES17

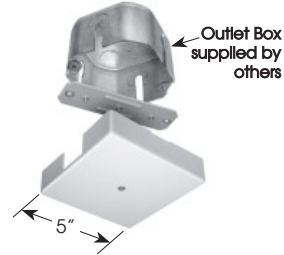

J-Box Kit
675-0094K

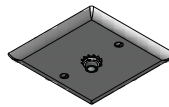

(for Nordic track adapter)

Monopoint
GES70

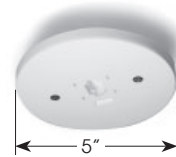

Track Reinforcement Plate
GEA21



Accessories not shown:
GES67 - floating canopy feed
677-0801 - T-bar ceiling clip
(15/16" Flat T-Grid)

ELECTRICAL

Single circuit, 120v track
20 amp max.

ORDERING INFORMATION:

TRACK Model	Finish	COMPONENTS (ordered separately) Model	Finish
GES204 (44")	1 - gray	GES11 - live end	1 - gray
GES208 (92")	2 - black	GES12 - live end, reverse	2 - black
GES212 (140")	3 - white	GES13 - conduit end	3 - white
		GES14 - center feed	
		GES17 - T-bar feed kit	
		GES21 - straight connector	
		GES34 - L connector, feedable, adjustable universal polarity	
		GES38 - X connector, feedable	
		GES40 - T connector, feedable, adjustable universal polarity	
		GES41 - dead end	
		GES67 - floating canopy feed	
		GES70 - monopoint	
		636-0297K - T-bar ceiling clip assembly kit for 15/16" Flat T-Grid (for 9/16" Flat T-Grid consult factory)	
		644-5146 - Flex connector	
		GEA21 - track reinforcement plate	
		675-0094K - J-Box Kit, specify color (WT, BT, ST)	

Track Example: GES204-2
Component Example: GES11-2

Cat #:

Amerlux reserves the right to change details that do not affect overall function and performance.



GLOBAL TRACK SINGLE CIRCUIT 120V

GES
1 CIR 120V



TYPE:



GES Track Configuration and Components

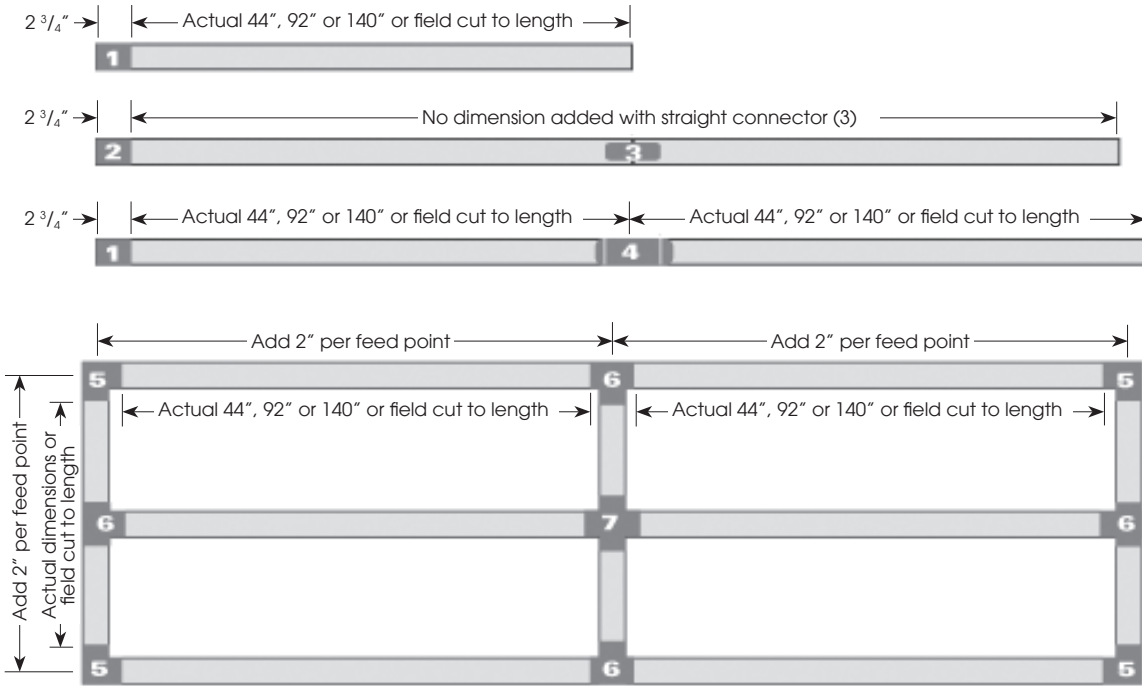

1. Live End Feed
GES11



2. Conduit End Feed
GES13



3. Straight Connector
GES21



7. X Connector
(feedable)
GES38



Flex Connector
644-5146



4. Center Feed
GES14



5. L Connector (feedable)
GES34



6. T Connector (feedable)
GES40



T-GRID SUSPENSION

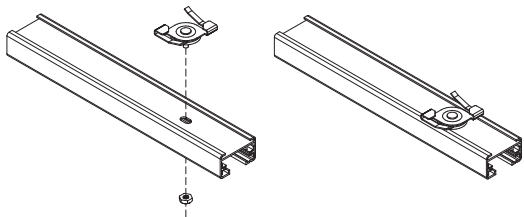

STEM MOUNT SUSPENSION

Stem mounts are field cuttable

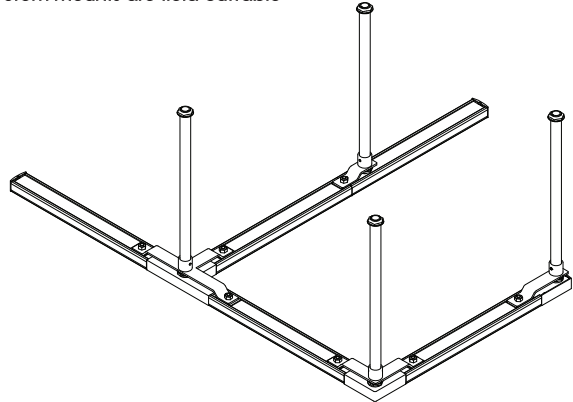

AIRCRAFT CABLE SUSPENSION

