

# GLOBAL TRACK

2 CIRCUIT/2 NEUTRAL 120V

TEK  
2CIR 120V

**APPLICATIONS:**

Power supply for Amerlux track lighting fixtures

**CONSTRUCTION:**

Architectural grade, extruded aluminum housing  
Milled grounding bar provides continuous ground contact  
Continuously crimped conductor ensures mechanical strength and electrical reliability  
Black, white or gray powder coat finish

**MOUNTING:**

T-grid, threaded rod or aircraft cable suspension  
Max. 6' O.C. suspension points

**LABELING:**



PROJECT:  
  
TYPE:

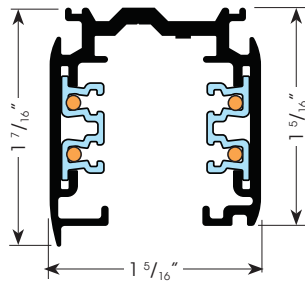

**ELECTRICAL**

2 circuit/2 neutral, 120V track  
20 amps per circuit

**ORDERING INFORMATION:**

TRACK Model	Finish	COMPONENTS (ordered separately)		Finish
		Model	Model	
TEK44 4' (48")	1 - gray	TEK11 - live end, left	TEK40 - T connector, adjustable left polarity	1 - gray
TEK48 8' (96")	2 - black	TEK12 - live end, right	TEK41 - dead end	2 - black
TEK412 12' (144")	3 - white	TEK14 - live center feed	636-0171K - T-bar clip assembly kit for 15/16" Flat T-Grid (for 9/16" Flat T-Grid consult factory)	3 - white
		TEK21 - straight connector		
		TEK24 - adjustable connector		
		TEK34 - L connector, adjustable universal polarity	636-0068 - cable gripper	
		TEK38 - X connector	614-0005 - aircraft cable, 20ft	
		TEK39 - T connector, adjustable right polarity	675-0094K - J-box cover	
			SKB12-1 - ceiling clamp (for cable and rod mounting, aluminum finish only)	
			XTSV12 - bending tool	

Example: TEK48-2

Cat #:

Amerlux® reserves the right to change details that do not affect overall function and performance.



# GLOBAL TRACK

2 CIRCUIT/2 NEUTRAL 120V



TYPE:

TEK  
2CIR 120V



## TEK TRACK CONFIGURATION & COMPONENTS:

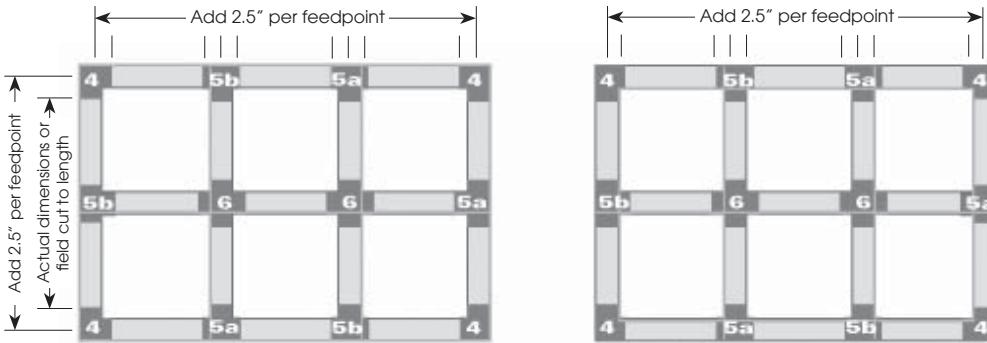
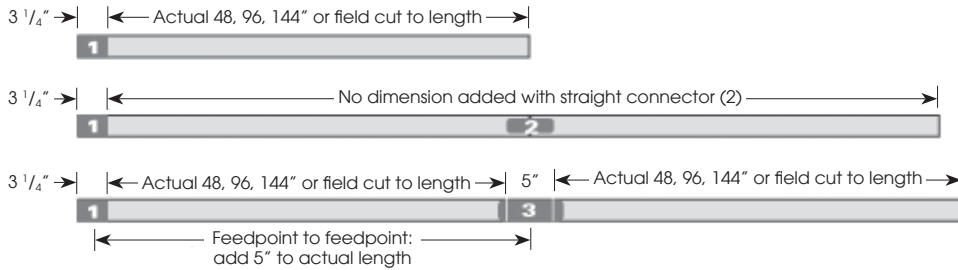

TEK is polarized and manufactured with identifying ridges (the larger shown as a bold line on diagrams). Refer to these diagrams to ensure proper connector selection.

### Additional Accessories (not pictured):

- SKB12-1 Ceiling clamp
- 636-0171K T-bar Clip Assembly Kit for 15/16" Flat T-Grid
- 636-0068 Cable Gripper
- 614-0005 A/C cable, 20ft
- 675-0094K J-box Cover
- XTSV12 bending tool



TEK41 Dead End



TEK24 Adjustable Connector

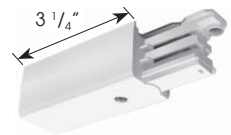

TEK11 Live End (left) - standard  
TEK12 Live End (right)  
(used for conduit feed also)



TEK21 Straight Connector

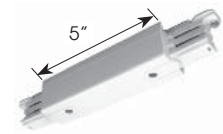

TEK14 Live Center Feed

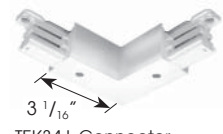

TEK34 L Connector  
(adjustable universal polarity)

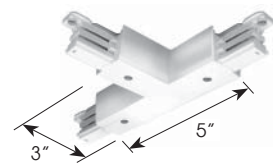

TEK39 T Connector  
(adjustable right polarity)  
HTEK40 T Connector  
(adjustable left polarity)

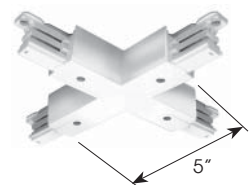

TEK38 X Connector

## SUSPENSION OPTIONS:

### T-GRID SUSPENSION

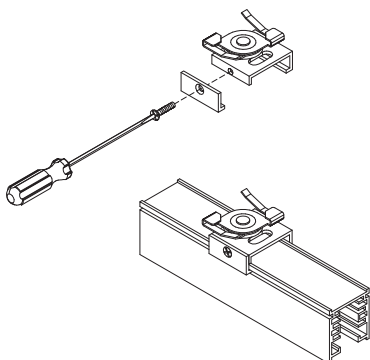

### AIRCRAFT CABLE SUSPENSION

