

GLOBAL TRACK

2 CIRCUIT/2 NEUTRAL 120V

TEK
2CIR 120V

APPLICATIONS:

Power supply for Amerlux track lighting fixtures

CONSTRUCTION:

Architectural grade, extruded aluminum housing
Milled grounding bar provides continuous ground contact
Continuously crimped conductor ensures mechanical strength and electrical reliability
Black, white or gray powder coat finish

MOUNTING:

T-grid, threaded rod or aircraft cable suspension
Max. 6' O.C. suspension points

LABELING:



PROJECT:

TYPE:

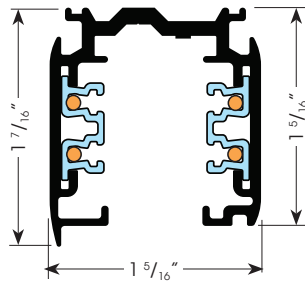

ELECTRICAL

2 circuit/2 neutral, 120V track
20 amps per circuit

ORDERING INFORMATION:

TRACK Model	Finish	COMPONENTS (ordered separately) Model	Model	Finish
TEK44 4' (48")	1 - gray	TEK11 - live end, left	TEK40 - T connector, adjustable left polarity	1 - gray
TEK48 8' (96")	2 - black	TEK12 - live end, right	TEK41 - dead end	2 - black
TEK412 12' (144")	3 - white	TEK14 - live center feed	636-0171K - T-bar clip assembly kit for 15/16" Flat T-Grid (for 9/16" Flat T-Grid consult factory)	3 - white
		TEK21 - straight connector	636-0068 - cable gripper	
		TEK24 - adjustable connector	614-0005 - aircraft cable, 20ft	
		TEK34 - L connector, feedable, adjustable universal polarity	675-0094K - J-box cover	
		TEK38 - X connector, feedable	SKB12-1 - ceiling clamp (for cable and rod mounting, aluminum finish only)	
		TEK39 - T connector, feedable, adjustable right polarity	XTSV12 - bending tool	

Example: TEK48-2

Cat #:

Amerlux® reserves the right to change details that do not affect overall function and performance.



GLOBAL TRACK

2 CIRCUIT/2 NEUTRAL 120V



TYPE:

TEK
2CIR 120V



TEK TRACK CONFIGURATION & COMPONENTS:

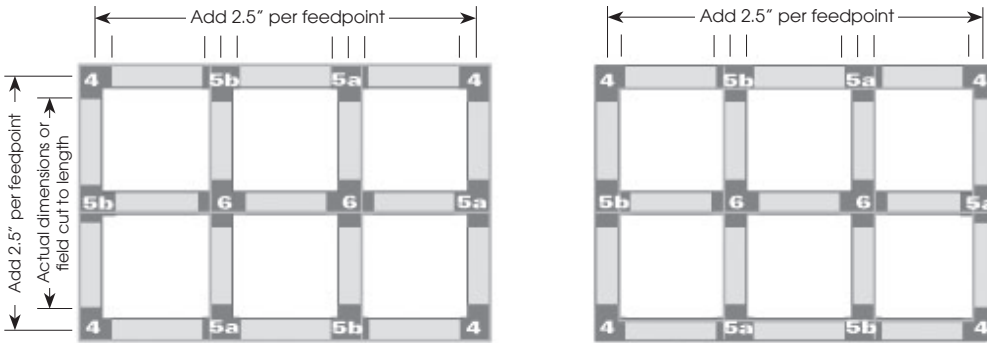
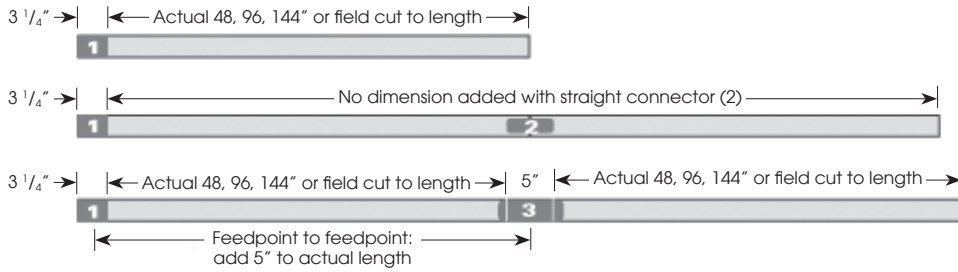

TEK is polarized and manufactured with identifying ridges (the larger shown as a bold line on diagrams). Refer to these diagrams to ensure proper connector selection.

Additional Accessories (not pictured):

- SKB12-1 Ceiling clamp
- 636-0171K T-bar Clip Assembly
Kit for 15/16" Flat T-Grid
- 636-0068 Cable Gripper
- 614-0005 A/C cable, 20ft
- 675-0094K J-box Cover
- XTSV12 bending tool



TEK41 Dead End



TEK24 Adjustable Connector

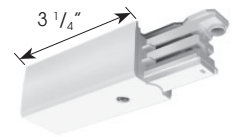

TEK11 Live End (left) - standard
TEK12 Live End (right)
(used for conduit feed also)

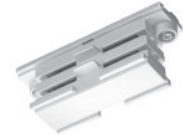

TEK21 Straight Connector

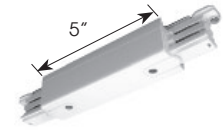

TEK14 Live Center Feed

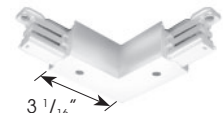

TEK34 L Connector (feedable)
(adjustable universal polarity)

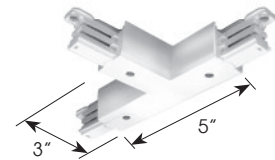

TEK39 T Connector (feedable)
(adjustable right polarity)
TEK40 T Connector (feedable)
(adjustable left polarity)

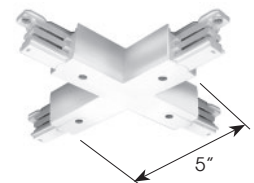

TEK38 X Connector (feedable)

SUSPENSION OPTIONS:

T-GRID SUSPENSION

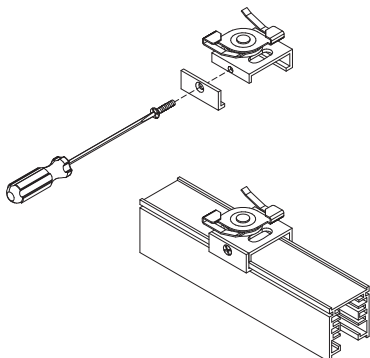

AIRCRAFT CABLE SUSPENSION

