

# HORNET® HIGH POWER

## TRACK HEAD LED

### APPLICATION

Accent and display lighting for retail, commercial & hospitality environments

### CONSTRUCTION:

Complete die-cast construction  
No exposed wiring  
Powder coat paint

### ELECTRICAL:

Electronic constant current LED driver, 120v - 277v input  
Triac and ELV dimming standard, 120v and 277v.  
See following pages for more information.

**This product complies with IEEE C62.41 for surge endurance up to 2.5KV. Amerlux® recommends using additional surge protection with this unit (supplied by others), surge damage is not covered by warranty.**

### MOUNTING:

Track, canopy, c-clamp and busway  
**Note: Ceiling mounted track only**

### OPTICS:

0-180° tilt, 360° rotation  
Available in a variety of beam spreads  
LED:  
Color Temp Options: 2200K, 2700K, 3000K, 3500K, 4000K  
CRI: 83 typ. (2700K, 3000K, 3500K, 4000K)  
90+ typ. (2200K, 2700K, 3000K)  
CrispWhite & Class A LEDs available  
R9 Values: 11 (83CRI), 55 (90+CRI)  
Binning: 3 MacAdam  
Lumen Maintenance: >70% of initial lumens @ 50,000 hrs  
Lumen Output (18w, 3000K): SP 1369 lm (75 lm/w)  
CBCP (18w, 3000K): SP 12,215

### ACCESSORIES:

**Snoot:** Die-cast aluminum, 1" length, painted finish  
**Cross Blade:** Stamped steel painted optical matte black cross blade sits in snoot which must be ordered when using cross blade

### LABELING:



For indoor use only

## HORNET-HP-A14 LED



PROJECT:

TYPE:

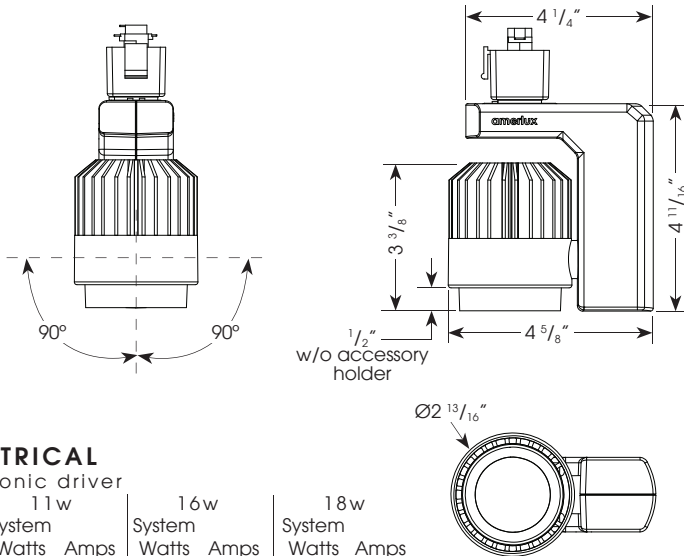

### ELECTRICAL

Electronic driver

	11w		16w		18w	
	System Watts	Amps	System Watts	Amps	System Watts	Amps
120v	11	0.09	16	0.13	18	0.15
277v	11	0.04	16	0.06	18	0.07

### Accessory Options:

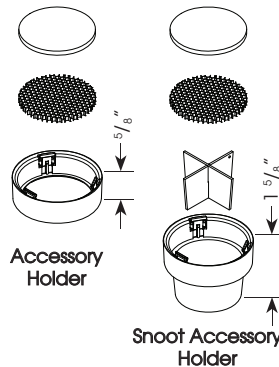

Electrostatic sensitive device, observe precautions for handling

(see next page for details)



(see page 5-6)

**5** year limited warranty  
AMERLUX LED  
(see website for details)

### ORDERING INFORMATION:

Model	Wattage	Lamp Type	Finish	Mounting	Voltage	Beam Spread*	Color Temp (CCT-CRI)	Options/Accessories
HORNET-HP-A14	11 16 18	LED	WT - white texture BT - black texture ST - silver texture - - - - - (other RAL)	TN1 - Global GES 1cir/H-Style, 120v TEK - Global TEK 2cir/2neut, 120v TN3 - Global XTS 3cir, 120v TN2 - Global HTEK 2cir/2neut, 277v CT - J-Style, 120v LOL - L-Style, 120v CPR - Capri/Prescolite compatible LLAB - Litelab Bus Run, 120v B - busway (compact series B40,B60c only, consult factory for other busway adapters) C - canopy CCL2 - C-clamp with SCP - straight cord, 6' CCP - coil cord, 5'	120 277	SP - spot, 15° NF - narrow flood, 22° MFL - medium flood, 25° FL - flood, 28° WF - wide flood, 45° VWF - very wide flood, 60° LS - linear spread, 60° x 10°	27 - 2700K-83 30 - 3000K-83 35 - 3500K-83 40 - 4000K-83 229 - 2200K-90+ 279 - 2700K-90+ 309 - 3000K-90+ CRISP - CrispWhite (16w max) 3CLA - 3K Class A	SNAH - snoot accessory holder, 1" length, matte black interior, specify exterior color (WT, BT, ST) accepts cross blade plus 2 additional forms of media AH - accessory holder, specify finish (WT, BT, ST), accepts 2 forms of media CB - cross blade, matte black finish, requires snoot HEX - hexcell louver ( $\frac{1}{8}$ " x $\frac{1}{8}$ " ), requires SNAH or AH SOL - solite beam softening lens, requires SNAH or AH

Example: HORNET-HP-A14-18-LED-WT-TN1-120-FL-30

Cat #:

Amerlux reserves the right to change details that do not affect overall function and performance.



# QUICKSHIP HORNET<sup>®</sup> HIGH POWER TRACK HEAD LED

HORNET-HP-A14  
LED

Amerlux<sup>®</sup> QuickShip makes it possible not only to keep up with expectations, but to keep ahead of them. We help enhance your competitive edge, ensuring you can start installation more quickly than you thought possible.

We can ship within 5-10 business days of your Amerlux QuickShip order, depending upon the selection.

- **QuickShip must be clearly marked on all P.O.'s.**
- **Must note on P.O. if requesting frames ship first.**
- **Standard shipping terms apply.**
- **See terms & conditions below.**

**Quantity:** 250 pieces or less  
5 days



PROJECT:

TYPE:

## QUICKSHIP ORDERING INFORMATION:

Model	Wattage	Lamp Type	Finish	Mounting	Voltage	Beam Spread	Color Temp (CCT-CRI)	Options/ Accessories
HORNET-HP-A14	16 18	LED	WT - white texture BT - black texture	TN1 - Global GES 1cir/ H-style, 120v CT - J-style, 120v LOL - L-style, 120v	120	SP - spot, 15° NF - narrow flood, 22° MFL - medium flood, 25° FL - flood, 28° WF - wide flood, 45° VWF - very wide flood, 60° LS - linear spread, 60° x 10°	30 - 3000K-83 309 - 3000K-90+	SNAH - snoot accessory holder (specify WT, BT) AH - accessory holder, accepts 2 forms of media; (specify WT, BT) CB - cross blade, (requires SNAH) HEX - hexcell louver (requires SNAH or AH)

Complete **QuickShip** Example: HORNET-HP-A14-16-LED-WT-TN1-120-SP-30-SNAH

Cat #:

## Terms & Conditions

1. For QuickShip processing, please submit QuickShip items on separate purchase order and indicate "QuickShip" on order.
2. Configurations outside of what is displayed on the QuickShip program are not available under the QuickShip lead times.
3. Please contact Customer Support to process orders with quantities larger than those listed.
4. Orders will be entered within 24 hours of receipt of a clean purchase order. Lead times are calculated by business days from time of sales order confirmation. Orders will ship within QuickShip lead times or sooner.
5. Change orders and order cancellations cannot be processed after sales order confirmation is generated.
6. For freight allowed (greater than \$3,000), order will ship complete based on longest lead time item. Please indicate on PO if Partial Shipments are approved and indicate freight method. For partial shipments under \$3,000, customer will be invoiced for freight.
7. All Lead times indicate when the fixture ships from Amerlux<sup>®</sup>. Arrival at destination is contingent upon carrier.

### Expedite your orders by providing:

- **Separate purchase order noting "QuickShip Program"**
- **Complete and accurate configurations**
- **Accurate pricing, quote number, shipping and contact information**

**Amerlux reserves the right to modify this program at any time.**

# HORNET® HIGH POWER

TRACK HEAD LED

HORNET-HP-A14  
LED



TYPE:



**FIXTURE DATA:** For 11w data, multiply by 0.71; For 16w data, multiply by 0.88

Complete photometric data (ies format) available upon request.

## 18W LED

Spot (SP)  
Distribution  
LTL #855377  
Lumens: 1,369

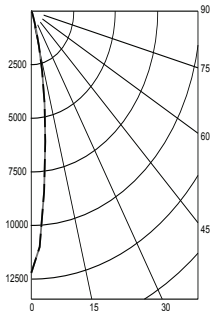

Candelas at Nadir	
Deg	Candela
0	12215
5	8436
15	1705
25	204
35	77
45	26

Narrow Flood (NF)  
Distribution  
LTL #860527  
Lumens: 1,307

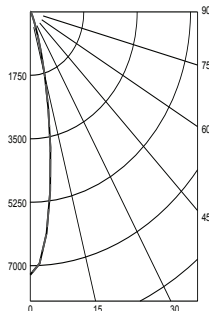

Candelas at Nadir	
Deg	Candela
0	7252
5	6128
15	1841
25	309
35	93
45	41

Flood (FL)  
Distribution  
LTL # 860528  
Lumens: 1,285

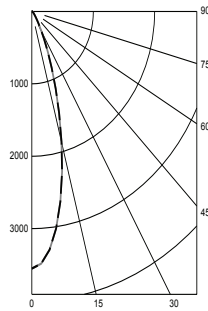

Candelas at Nadir	
Deg	Candela
0	3551
5	3304
15	1861
25	612
35	156
45	57

Wide Flood (WF)  
Distribution  
LTL # 860529  
Lumens: 1,278

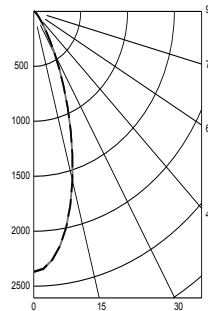

Candelas at Nadir	
Deg	Candela
0	2369
5	2268
15	1592
25	754
35	251
45	82

## APPLICATION DATA:

### Notes and Definitions:

Beam spread is to 50% center beam candlepower (CBCP).  
 D=Distance to floor or wall.  
 FC=Footcandles on floor or wall at center beam aiming location.  
 L=Effective Visual Beam length in feet (50% of maximum footcandle level).  
 W=Effective Visual Beam width in feet (50% of maximum footcandle level).  
 CB=Distance across or down to center beam location.

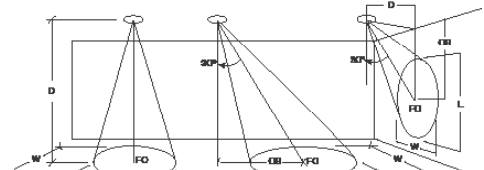

0° Aiming Angle  
Horizontal  
Footcandles



30° Aiming Angle  
Horizontal  
Footcandles



30° Aiming Angle  
Vertical  
Footcandles



60° Aiming Angle  
Vertical  
Footcandles

	0° Aiming Angle Horizontal Footcandles				30° Aiming Angle Horizontal Footcandles					30° Aiming Angle Vertical Footcandles					60° Aiming Angle Vertical Footcandles				
	D	FC	L	W	D	FC	L	W	CB	D	FC	L	W	CB	D	FC	L	W	CB
SPOT	5.0'	484	1.4	1.4	5.0'	313	1.8	1.5	3.0	3.0'	178	3.0	1.6	5.0	3.0'	630	1.6	1.1	2.0
	7.5'	216	2.0	2.0	7.5'	136	2.8	2.4	4.0	4.0'	105	3.8	2.1	6.0	4.0'	450	1.6	1.3	2.0
	10.0'	122	2.7	2.7	10.0'	76	3.7	3.2	6.0	5.0'	67	4.8	2.7	8.0	5.0'	298	2.0	1.6	3.0
	12.5'	78	3.4	3.4	12.5'	46	4.8	4.2	7.0	6.0'	47	5.9	3.2	9.0	6.0'	200	2.4	1.9	3.0
NARROW FLOOD	5.0'	289	1.7	1.7	5.0'	187	2.4	2.1	3.0	3.0'	127	3.3	1.8	4.0	3.0'	422	1.9	1.3	2.0
	7.5'	129	2.8	2.8	7.5'	86	3.5	3.1	4.0	4.0'	70	4.4	2.7	6.0	4.0'	298	1.9	1.5	2.0
	10.0'	73	3.6	3.6	10.0'	47	4.7	4.1	5.0	5.0'	47	5.3	3.2	7.0	5.0'	181	2.5	2.1	3.0
	12.5'	47	4.5	4.5	12.5'	31	5.8	5.2	7.0	6.0'	32	6.7	3.9	8.0	6.0'	133	2.8	2.5	3.0
FLOOD	5.0'	142	2.7	2.7	5.0'	92	3.4	3.1	3.0	3.0'	75	3.8	2.7	4.0	3.0'	232	2.3	1.7	2.0
	7.5'	63	3.9	3.9	7.5'	43	4.9	4.4	4.0	4.0'	44	4.9	3.3	5.0	4.0'	154	2.7	2.4	2.0
	10.0'	36	5.2	5.2	10.0'	25	6.4	5.8	5.0	5.0'	29	6.1	4.1	6.0	5.0'	95	3.4	3.0	2.0
	12.5'	23	6.5	6.5	12.5'	16	8.0	7.2	6.0	6.0'	20	7.4	5.1	7.0	6.0'	69	3.8	3.5	3.0
WIDE FLOOD	5.0'	95	3.2	3.2	5.0'	67	3.9	3.4	2.0	3.0'	63	3.7	2.8	3.0	3.0'	180	2.4	2.0	1.0
	7.5'	42	4.8	4.8	7.5'	30	5.7	5.3	3.0	4.0'	36	4.9	3.7	4.0	4.0'	105	3.2	2.9	2.0
	10.0'	24	6.4	6.4	10.0'	17	7.6	7.1	4.0	5.0'	23	6.1	4.8	5.0	5.0'	69	3.8	3.5	2.0
	12.5'	15	8.0	8.0	12.5'	11	9.6	8.9	5.0	6.0'	16	7.5	5.7	6.0	6.0'	47	4.7	4.3	3.0

# HORNET® HIGH POWER

TRACK HEAD LED

HORNET-HP-A14  
LED



TYPE:



**DIMMING COMPATIBILITY:**

Amerlux® "Hornet" track head is compatible with TRIAC and ELV dimming protocols prevalent in the United States. Please see below for general compatibilities and wiring diagrams. Amerlux recommends testing your unique dimming configuration as the exact full configuration (Dimmer, Fixture Quantity, Voltage, etc) may affect dimming performance.

**TRIAC (Forward Phase) DIMMING (standard)**

Utilizes "Standard" incandescent dimmers that are in wide use in installations across the US. Best for retrofit applications where Triac dimmers are installed.

**Notes:**

- 120v and 277v
- Dims down to less than 5% light output (most cases)
- Consult Dimming manufacturer for installation instructions - DO NOT SHARE NEUTRALS!
- Must meet dimmer Minimum Load Requirements per dimming manufacturer

Wiring Diagram

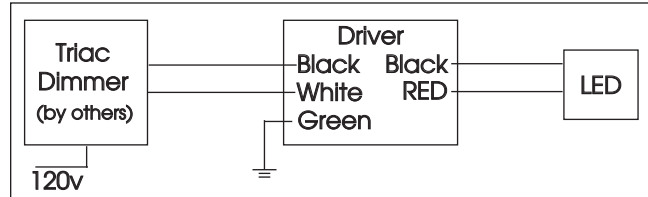

**Compatible Dimmers**

**Wall Box (Incandescent Style, Wattage as required)**

Lutron "Diva"	Lutron "Vareo"
Lutron "Nova-T"	Lutron "Skylark"
Lutron "Maestro"	

**Central System**

ETC "SR" Rack w/D20 Module	ETC "DRD" Rack w/D20 Module
Lutron "GP" Panel	Lutron Grafix Eye QS

**ELV - Electronic Low Voltage (Reverse Phase) DIMMING (standard)**

Utilizes specialized "ELV" dimmers. Best for New Construction applications

**Notes:**

- 120v and 277v
- Dims down to less than 5% light output (most cases)
- Consult Dimming manufacturer for installation instructions - DO NOT SHARE NEUTRALS!
- Must meet dimmer Minimum Load Requirements

Wiring Diagram

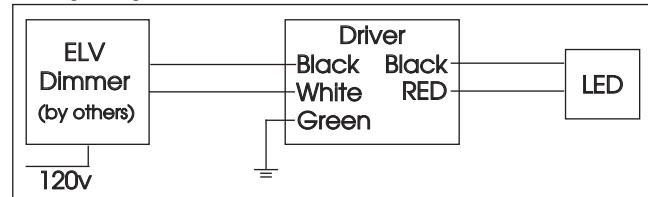

**Compatible Dimmers**

**Wall Box (ELV Style)**

Lutron "Diva"	Lutron "Vareo"
Lutron "Nova-T"	Lutron "Skylark"
Lutron "Maestro"	
Leviton "Surslide"	Leviton "Vizio"

**Central System**

ETC "SR" Rack w/ELV10 Module	ETC "DRD" Rack w/ELV10 Module
Lutron "GP" Panel with PHPM-PA Interface	Lutron Grafix Eye QS with PHPM-PA Interface

# HORNET® HIGH POWER

TRACK HEAD LED

HORNET-HP-A14  
LED



TYPE:



ENERGY STAR APPROVED MODEL NUMBERS:



## Certificate of Conformance

### Energy Efficiency Certification

UL conducted an independent evaluation on behalf of:

#### Amerlux Global Lighting Solutions

178 Bauer Dr., Oakland, NJ 07436

for the following products:

Indoor Directional Luminaire

Brand: Amerlux

Model Name: Hornet

Model Numbers: See Appendix A

This product meets all of the necessary  
qualifications pursuant to:

ENERGY STAR® Program Requirements for  
Luminaires, Version 2.0



### Energy Verified

2016-11-01

Certification Date

N/A

Certification Revision Date

Issued by

11470949

UL Product Number

00-VS-F0418, Version 2.0, This is to certify that representative samples of the Certified Product(s) listed above have been investigated by UL to the Standard(s) indicated on this certificate, in accordance with the UL Global Services Agreement and the EEC Terms & Conditions ("Agreement"). The Certificate Holder is entitled to use the UL Energy Verified Mark for the Certified Product(s) listed on the certificate and manufactured at the production site(s) covered by the UL Test Report, in accordance with the terms of the Agreement. This Certificate shall remain valid unless a Standard identified on this Certificate is amended or withdrawn prior to that date or there is a non-compliance with the Agreement.

# HORNET® HIGH POWER

TRACK HEAD LED

HORNET-HP-A14  
LED



TYPE:



ENERGY STAR APPROVED MODEL NUMBERS:



## Appendix A

Model Number	Additional Model Number	Additional Model Number
HORNET-HP-A14-11-LED-**-**#- ###**-2700-92	HORNET-HP-A14-11-LED-**-**#- ###**-3000-92	HORNET-HP-A14-11-LED-**-**#- ###**-3500
	HORNET-HP-A14-11-LED-**-**#- ###**-2700	HORNET-HP-A14-11-LED-**-**#- ###**-4000
	HORNET-HP-A14-11-LED-**-**#- ###**-3000	HORNET-HP-A14-11-LED-**-**#- ###**-CRISP

Model Number	Additional Model Number	Additional Model Number
HORNET-HP-A14-16-LED-**-**#- ###**-2700-92	HORNET-HP-A14-16-LED-**-**#- ###**-3000-92	HORNET-HP-A14-16-LED-**-**#- ###**-3500
	HORNET-HP-A14-16-LED-**-**#- ###**-2700	HORNET-HP-A14-16-LED-**-**#- ###**-4000
	HORNET-HP-A14-16-LED-**-**#- ###**-3000	HORNET-HP-A14-16-LED-**-**#- ###**-CRISP

Model Number	Additional Model Number	Additional Model Number
HORNET-HP-A14-18-LED-**-**#- ###**-2700-92	HORNET-HP-A14-18-LED-**-**#- ###**-3000-92	HORNET-HP-A14-18-LED-**-**#- ###**-3500
	HORNET-HP-A14-18-LED-**-**#- ###**-2700	HORNET-HP-A14-18-LED-**-**#- ###**-4000
	HORNET-HP-A14-18-LED-**-**#- ###**-3000	HORNET-HP-A14-18-LED-**-**#- ###**-CRISP