

# HORNET® HIGH POWER

## RECESSED MULTIPLE 4 LIGHT LED

HORNET-HP-R-  
A14-4  
4LT LED

### APPLICATION:

Accent and display lighting for retail, commercial and hospitality environments

### CONSTRUCTION:

Stamped steel mounting frame with integral mounting bars  
Thermally protected  
Steel driver housing  
Steel upper housing and laser cut trim ring  
Complete die-cast optical head construction  
No exposed wiring  
Powder coat paint

### ELECTRICAL:

Electronic constant current LED driver, 120v or 277v input  
ELV and Triac dimming standard, 120v and 277v.  
0-10v and Lutron systems also available. See following pages for more information.

**This product complies with IEEE C62.41 for surge endurance up to 2.5KV. Amerlux® recommends using additional surge protection with this unit (supplied by others), surge damage is not covered by warranty.**

### OPTICS:

0-35° tilt, 360° rotation  
Available in a variety of beam spreads  
LED:  
Color Temp Options: 2200K, 2700K, 3000K, 3500K, 4000K  
CRI: 83 typ. (2700K, 3000K, 3500K, 4000K)  
90+ typ. (2200K, 2700K, 3000K)  
Crisp White LED available (16w max)  
R9 Values: 11 (83CRI), 55 (90+CRI)  
Life: 50,000 hrs  
Binning: 3 MacAdam  
Lumen Maintenance: >70% of initial lumens @ 50,000 hrs  
Lumen Output (18w, 3000K): SP 1369 lm (75 lm/w)  
CBCP (18w, 3000K): SP 12,215

### MOUNTING:

For use in T-grid or sheet rock ceilings, max thickness 1"

### LABELING:

 pending approval to UL standards as tested by CSA  
For indoor use only



PROJECT:

TYPE:

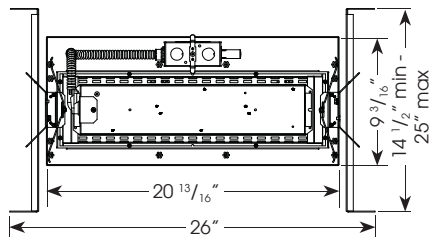

Ceiling Cut Out Dimension: 5 9/16" x 19 5/16"

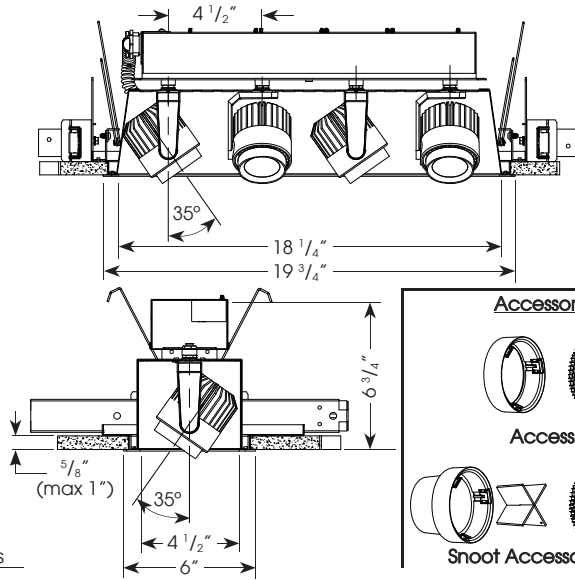

### Accessory Options:

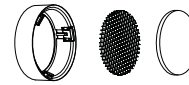

### Accessory Holder

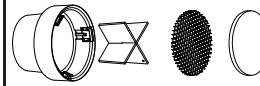

### Snoot Accessory Holder

  
Electrostatic sensitive device,  
observe precautions for  
handling



(see next page for details)



(see page 6-7)

**5** year limited  
warranty  
AMERLUX LED

(see website for details)

### ELECTRICAL

Electronic driver

	4x11w		4x16w		4x18w	
	System Watts	Amps	System Watts	Amps	System Watts	Amps
120v	44	0.37	64	0.53	72	0.60
277v	44	0.16	64	0.23	72	0.26

### ORDERING INFORMATION:

FRAME Model	# Heads	Lamp Type	Voltage	Options/Accessories
HORNET-HP-R/SR-FRAME	4	LED	120 277	HILUME - Lutron Hi-Lume® dimming driver 0-10V - 0-10v dimming EM - emergency battery pack (1 head)

Complete Unit Specification:

HORNET-HP-R/SR-FRAME-4-LED-120/HORNET-HP-R-TRIM-A14-4-18-LED-WT-120-277-FL-FL-FL-FL-WT-30

Frame Only: HORNET-HP-R/SR-FRAME-4-LED-120

Trim Only: HORNET-HP-R-TRIM-A14-4-18-LED-WT-120-277-FL-FL-FL-FL-WT-30

TRIM Model	# Heads	Wattage	Lamp Type	Housing/Head Finish	Voltage	Beam Spreads*	Trim Finish	Color Temp (CCT(K)-CRI)	Options/Accessories
HORNET-HP-R-TRIM-A14-4	4	11 16 18	LED	WT - white texture BT - black texture ST - silver texture (other RAL)	120-277	SP	WT - white	27 - 2700-83	SNAH - snoot accessory holder, 1", matte black interior, specify exterior color (WT, BT, ST), accepts cross blade plus 2 additional forms of media AH - accessory holder, specify finish (WT, BT, ST), accepts 2 forms of media CB - cross blade, matte black finish, requires snoot HEX - hexcell louver (1/8" x 1/8"), requires SNAH or AH SOL - solite beam softening lens, requires SNAH or AH HILUME - Lutron Hi-Lume® dimming driver 0-10V - 0-10v dimming EM - emergency battery pack (1 head)
						NF	30 - 3000-83		
						MFL	35 - 3500-83		
						FL	40 - 4000-83		
						WF	229 - 2200-90+		
						VWF*	279 - 2700-90+		
						LS*	309 - 3000-90+		
						CRISP - CrispWhite (16W max)			

\*Note: VWF and LS beam spreads are not Energy Star® rated

\*SP - spot 15°, NF - narrow flood 22°, MFL - medium flood 25°, FL - flood 28°, WF - wide flood 45°, VWF - very wide flood 60°, LS - linear spread 60°x10°

Cat #:

Amerlux reserves the right to change details that do not affect overall function and performance.



# QUICKSHIP HORNET® HIGH POWER RECESSED MULTIPLE 4 LIGHT LED

HORNET-HP-R-  
A14-4  
4LT LED

Amerlux® QuickShip makes it possible not only to keep up with expectations, but to keep ahead of them. We help enhance your competitive edge, ensuring you can start installation more quickly than you thought possible.

We can ship within 5-10 business days of your Amerlux QuickShip order, depending upon the selection.

- **QuickShip must be clearly marked on all P.O.'s.**
- **Must note on P.O. if requesting frames ship first.**
- **Standard shipping terms apply.**
- **See terms & conditions below.**

**Quantity:** 100 pieces or less  
Frames: 5 days  
Trims: 10 days



PROJECT:

TYPE:

## QUICKSHIP ORDERING INFORMATION:

Frame:				Trim:										Options		
Model	Heads	Lamp Type	Volts	Model	Heads	Watts	Lamp Type	Housing/ Head Finish	Volts	Beam Spread*				Trim Ring Finish	Color Temp (CCT(K)-CRI)	Accessories
										Hd 1	Hd 2	Hd 3	Hd 4			
HORNET-HP-R/SR-FRAME-A14	4	LED	120/277	HORNET-HP-R-TRIM-A14	4	16/18	LED	WT - white texture	120/277	SP	SP	SP	SP	WT- white texture	30 - 3000-83	SNAH - snoot accessory holder; (specify WT, BT)
										NF	NF	NF	NF		35 - 3500-83	AH - accessory holder, accepts 2 forms of media; (specify WT, BT)
										MFL	MFL	MFL	MFL			CB - cross blade, (requires SNAH)
										FL	FL	FL	FL			HEX - hexcell louver (requires SNAH or AH)
										WF	WF	WF	WF			
										VWF	VWF	VWF	VWF			

\*SP - spot 15°, NF - narrow flood 22°, MFL - medium flood 25°, FL - flood 28°, WF - wide flood 45°, VWF - very wide flood 60°, LS - linear spread 60°x10°

Complete **QuickShip** Example: HORNET-HP-R/SR-FRAME-A14-4-LED-120/HORNET-HP-R-TRIM-A14-4-16-LED-WT-120/277-SP-SP-SP-SP-WT-30

Frame Example: HORNET-HP-R/SR-FRAME-A14-4-LED-120

Trim Example: HORNET-HP-R-TRIM-A14-4-16-LED-WT-120/277-SP-SP-SP-SP-WT-30

Cat #:

## Terms & Conditions

1. For QuickShip processing, please submit QuickShip items on separate purchase order and indicate "QuickShip" on order.
2. Configurations outside of what is displayed on the QuickShip program are not available under the QuickShip lead times.
3. Please contact Customer Support to process orders with quantities larger than those listed.
4. Orders will be entered within 24 hours of receipt of a clean purchase order. Lead times are calculated by business days from time of sales order confirmation. Orders will ship within QuickShip lead times or sooner.
5. Change orders and order cancellations cannot be processed after sales order confirmation is generated.
6. For freight allowed (greater than \$3,000), order will ship complete based on longest lead time item. Please indicate on PO if Partial Shipments are approved and indicate freight method. For partial shipments under \$3,000, customer will be invoiced for freight.
7. All Lead times indicate when the fixture ships from Amerlux®. Arrival at destination is contingent upon carrier.

### Expedite your orders by providing:

- Separate purchase order noting "QuickShip Program"
- Complete and accurate configurations
- Accurate pricing, quote number, shipping and contact information

**Amerlux reserves the right to modify this program at any time.**

# HORNET® HIGH POWER

RECESSED MULTIPLE 4 LIGHT LED

HORNET-HP-R-  
A14-4  
4LT LED



TYPE:



**FIXTURE DATA:** For 11w data, multiply by 0.71; For 16w data, multiply by 0.88

Complete photometric data (ies format) available upon request.

Note: Data per head

## 18W LED

SPOT (SP)  
DISTRIBUTION  
LTL #855377

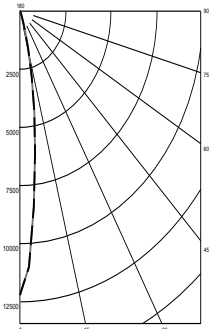

Candelas at Nadir	
Deg	Candela
0	12215
5	8436
15	1705
25	204
35	77
45	26

NARROW FLOOD (NF)  
DISTRIBUTION  
LTL #860527

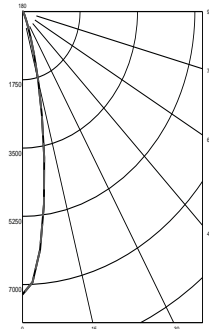

Candelas at Nadir	
Deg	Candela
0	7252
5	6128
15	1841
25	309
35	93
45	41

FLOOD (FL)  
DISTRIBUTION  
LTL # 860528

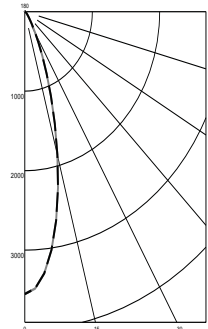

Candelas at Nadir	
Deg	Candela
0	3551
5	3304
15	1861
25	612
35	156
45	57

WIDE FLOOD (WF)  
DISTRIBUTION  
LTL # 860529

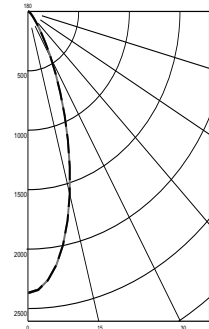

Candelas at Nadir	
Deg	Candela
0	2369
5	2268
15	1592
25	754
35	251
45	82

## APPLICATION DATA:

### Notes and Definitions:

Beam spread is to 50% center beam candlepower (CBCP).  
D=Distance to floor or wall.  
FC=Footcandles on floor or wall at center beam aiming location.  
L=Effective Visual Beam length in feet (50% of maximum footcandle level).  
W=Effective Visual Beam width in feet (50% of maximum footcandle level).  
CB=Distance across or down to center beam location.

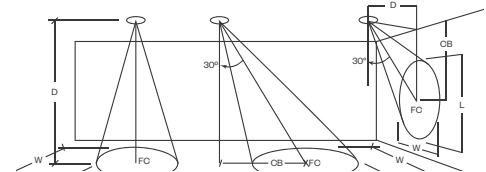

0° Aiming Angle  
Horizontal  
Footcandles



30° Aiming Angle  
Horizontal  
Footcandles



30° Aiming Angle  
Vertical  
Footcandles



60° Aiming Angle  
Vertical  
Footcandles

	0° Aiming Angle Horizontal Footcandles				30° Aiming Angle Horizontal Footcandles					30° Aiming Angle Vertical Footcandles					60° Aiming Angle Vertical Footcandles				
	D	FC	L	W	D	FC	L	W	CB	D	FC	L	W	CB	D	FC	L	W	CB
SPOT	5.0'	484	1.4	1.4	5.0'	313	1.8	1.5	3.0	3.0'	178	3.0	1.6	5.0	3.0'	630	1.6	1.1	2.0
	7.5'	216	2.0	2.0	7.5'	136	2.8	2.4	4.0	4.0'	105	3.8	2.1	6.0	4.0'	450	1.6	1.3	2.0
	10.0'	122	2.7	2.7	10.0'	76	3.7	3.2	6.0	5.0'	67	4.8	2.7	8.0	5.0'	298	2.0	1.6	3.0
	12.5'	78	3.4	3.4	12.5'	46	4.8	4.2	7.0	6.0'	47	5.9	3.2	9.0	6.0'	200	2.4	1.9	3.0
NARROW FLOOD	5.0'	289	1.7	1.7	5.0'	187	2.4	2.1	3.0	3.0'	127	3.3	1.8	4.0	3.0'	422	1.9	1.3	2.0
	7.5'	129	2.8	2.8	7.5'	86	3.5	3.1	4.0	4.0'	70	4.4	2.7	6.0	4.0'	298	1.9	1.5	2.0
	10.0'	73	3.6	3.6	10.0'	47	4.7	4.1	5.0	5.0'	47	5.3	3.2	7.0	5.0'	181	2.5	2.1	3.0
	12.5'	47	4.5	4.5	12.5'	31	5.8	5.2	7.0	6.0'	32	6.7	3.9	8.0	6.0'	133	2.8	2.5	3.0
FLOOD	5.0'	142	2.7	2.7	5.0'	92	3.4	3.1	3.0	3.0'	75	3.8	2.7	4.0	3.0'	232	2.3	1.7	2.0
	7.5'	63	3.9	3.9	7.5'	43	4.9	4.4	4.0	4.0'	44	4.9	3.3	5.0	4.0'	154	2.7	2.4	2.0
	10.0'	36	5.2	5.2	10.0'	25	6.4	5.8	5.0	5.0'	29	6.1	4.1	6.0	5.0'	95	3.4	3.0	2.0
	12.5'	23	6.5	6.5	12.5'	16	8.0	7.2	6.0	6.0'	20	7.4	5.1	7.0	6.0'	69	3.8	3.5	3.0
WIDE FLOOD	5.0'	95	3.2	3.2	5.0'	67	3.9	3.4	2.0	3.0'	63	3.7	2.8	3.0	3.0'	180	2.4	2.0	1.0
	7.5'	42	4.8	4.8	7.5'	30	5.7	5.3	3.0	4.0'	36	4.9	3.7	4.0	4.0'	105	3.2	2.9	2.0
	10.0'	24	6.4	6.4	10.0'	17	7.6	7.1	4.0	5.0'	23	6.1	4.8	5.0	5.0'	69	3.8	3.5	2.0
	12.5'	15	8.0	8.0	12.5'	11	9.6	8.9	5.0	6.0'	16	7.5	5.7	6.0	6.0'	47	4.7	4.3	3.0

# HORNET® HIGH POWER

RECESSED MULTIPLE 4 LIGHT LED

HORNET-HP-R-  
A14-4  
4LT LED



TYPE:



## DIMMING COMPATIBILITY:

Amerlux® "Hornet" fixtures are compatible with all major dimming protocols prevalent in the United States. Please see below for general compatibilities and wiring diagrams. Amerlux recommends testing your unique dimming configuration as the exact full configuration (Dimmer, Fixture Quantity, Voltage, etc) may affect dimming performance.

### TRIAC (Forward Phase) DIMMING (standard)

Utilizes "Standard" incandescent dimmers that are in wide use in installations across the US. Best for retrofit applications where Triac dimmers are installed.

#### Notes:

- 120v and 277v
- Dims down to less than 5% light output (most cases)
- Consult Dimming manufacturer for installation instructions - DO NOT SHARE NEUTRALS!
- Must meet dimmer Minimum Load Requirements per dimming manufacturer

#### Wiring Diagram

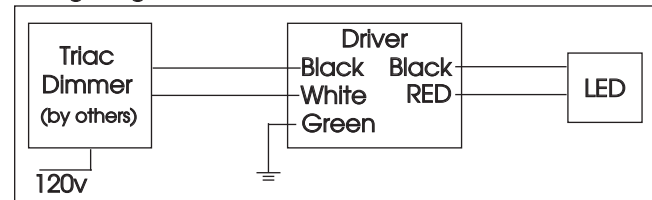

#### Compatible Dimmers

##### Wall Box (Incandescent Style, Wattage as required)

Lutron "Diva"  
Lutron "Nova-T"  
Lutron "Maestro"

Lutron "Vareo"  
Lutron "Skylark"

##### Central System

ETC "SR" Rack w/D20  
Module  
Lutron "GP" Panel

ETC "DRD" Rack w/D20  
Module  
Lutron Grafix Eye QS

### ELV - Electronic Low Voltage (Reverse Phase) DIMMING (standard)

Utilizes specialized "ELV" dimmers. Best for New Construction applications

#### Notes:

- 120v and 277v
- Dims down to less than 5% light output (most cases)
- Consult Dimming manufacturer for installation instructions - DO NOT SHARE NEUTRALS!
- Must meet dimmer Minimum Load Requirements

#### Wiring Diagram

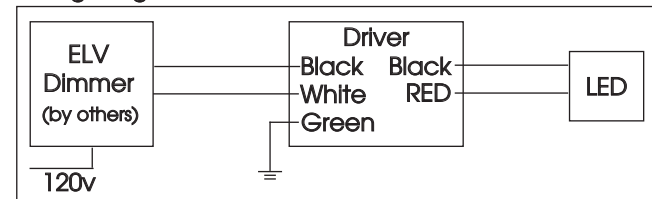

#### Compatible Dimmers

##### Wall Box (ELV Style)

Lutron "Diva"  
Lutron "Nova-T"  
Lutron "Maestro"  
Leviton "Surslide"

Lutron "Vareo"  
Lutron "Skylark"  
Leviton "Vizio"

##### Central System

ETC "SR" Rack w/ELV10  
Module  
Lutron "GP" Panel with  
PHPM-PA Interface

ETC "DRD" Rack w/ELV10  
Module  
Lutron Grafix Eye QS with  
PHPM-PA Interface

### 0-10V - DIMMING (-0-10V Option)

Integrates into a variety of building management and daylighting controls

#### Notes:

- 120v - 277v
- Dims down to less than 10% light output
- Requires interface to turn off power to driver
- Consult Dimming manufacturer for installation instructions - DO NOT SHARE NEUTRALS!

#### Wiring Diagram

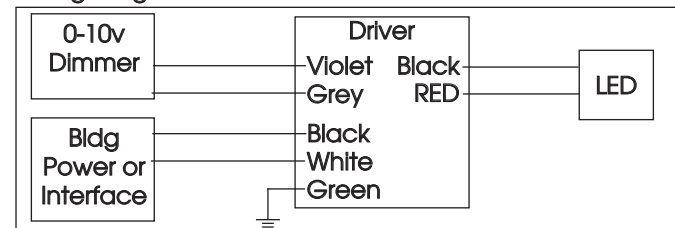

#### Compatible Dimmers

##### Wall Box

Lutron "Diva" - DVTV with  
PP-120H Interface

Leviton Renoir II 0-10v

##### Central System

Lutron Grafix Eye with  
GRX-TVI Interface

# HORNET® HIGH POWER

RECESSED MULTIPLE 4 LIGHT LED

HORNET-HP-R-  
A14-4  
4LT LED



TYPE:



## LUTRON HI-LUME / ECO-SYSTEM (-HILUME Option)

Integrates into a variety of building management and daylighting controls

### Notes:

- 120v or 277v
- Dims down to less than 5% light output
- May use 3-Wire or Ecosystem Control
- Consult Dimming manufacturer for installation instructions - DO NOT SHARE NEUTRALS!

### Compatible Dimmers

#### Wall Box (3-Wire Fluorescent)

DIVA  
Maestro  
Nova T  
Vareo

#### Central System

Lutron ECO-System compatible controls  
ETC "SR" Rack w/D20F Module  
ETC "DRD" Rack w/D20F Module

### 3-Wire Wiring Diagram

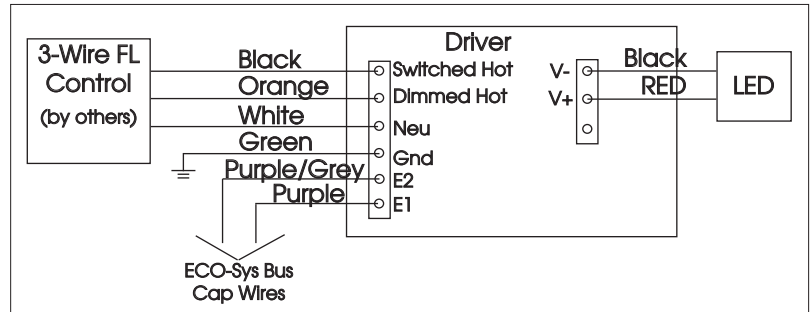

### ECO System Digital Control Wiring

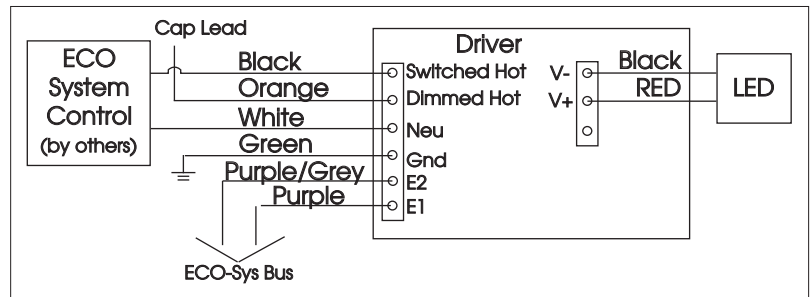

# HORNET® HIGH POWER

RECESSED MULTIPLE 4 LIGHT LED

HORNET-HP-R-  
A14-4  
4LT LED



TYPE:



ENERGY STAR APPROVED MODEL NUMBERS:



## Certificate of Conformance

### Energy Efficiency Certification

UL conducted an independent evaluation on behalf of:

#### Amerlux Global Lighting Solutions

178 Bauer Dr., Oakland, NJ 07436

for the following products:

Indoor Directional Luminaire

Brand: Amerlux

Model Name: Hornet

Model Numbers: See Appendix A

This product meets all of the necessary  
qualifications pursuant to:

ENERGY STAR® Program Requirements for  
Luminaires, Version 2.0



## Energy Verified

2016-11-01

Certification Date

N/A

Certification Revision Date

Issued by

11470949

UL Product Number

00-VS-F0418, Version 2.0, This is to certify that representative samples of the Certified Product(s) listed above have been investigated by UL to the Standard(s) indicated on this certificate, in accordance with the UL Global Services Agreement and the EEC Terms & Conditions ("Agreement"). The Certificate Holder is entitled to use the UL Energy Verified Mark for the Certified Product(s) listed on the certificate and manufactured at the production site(s) covered by the UL Test Report, in accordance with the terms of the Agreement. This Certificate shall remain valid unless a Standard identified on this Certificate is amended or withdrawn prior to that date or there is a non-compliance with the Agreement.

# HORNET® HIGH POWER

RECESSED MULTIPLE 4 LIGHT LED

HORNET-HP-R-  
A14-4  
4LT LED



TYPE:



ENERGY STAR APPROVED MODEL NUMBERS:



## Appendix A

Model Number	Additional Model Number	Additional Model Number
HORNET-HP-R/SR-FRAME-#-###-/HORNET-HP-R-TRIM-A14-#-11-LED-**-**#-###-**-2700-92	HORNET-HP-R/SR-FRAME-#-###-/HORNET-HP-R-TRIM-A14-#-11-LED-**-**#-###-**-3000-92	HORNET-HP-R/SR-FRAME-#-###-/HORNET-HP-R-TRIM-A14-#-11-LED-**-**#-###-**-3500
	HORNET-HP-R/SR-FRAME-#-###-/HORNET-HP-R-TRIM-A14-#-11-LED-**-**#-###-**-2700	HORNET-HP-R/SR-FRAME-#-###-/HORNET-HP-R-TRIM-A14-#-11-LED-**-**#-###-**-4000
	HORNET-HP-R/SR-FRAME-#-###-/HORNET-HP-R-TRIM-A14-#-11-LED-**-**#-###-**-3000	HORNET-HP-R/SR-FRAME-#-###-/HORNET-HP-R-TRIM-A14-#-11-LED-**-**#-###-**-CRISP

Model Number	Additional Model Number	Additional Model Number
HORNET-HP-R/SR-FRAME-#-###-/HORNET-HP-R-TRIM-A14-#-16-LED-**-**#-###-**-2700-92	HORNET-HP-R/SR-FRAME-#-###-/HORNET-HP-R-TRIM-A14-#-16-LED-**-**#-###-**-3000-92	HORNET-HP-R/SR-FRAME-#-###-/HORNET-HP-R-TRIM-A14-#-16-LED-**-**#-###-**-3500
	HORNET-HP-R/SR-FRAME-#-###-/HORNET-HP-R-TRIM-A14-#-16-LED-**-**#-###-**-2700	HORNET-HP-R/SR-FRAME-#-###-/HORNET-HP-R-TRIM-A14-#-16-LED-**-**#-###-**-4000
	HORNET-HP-R/SR-FRAME-#-###-/HORNET-HP-R-TRIM-A14-#-16-LED-**-**#-###-**-3000	HORNET-HP-R/SR-FRAME-#-###-/HORNET-HP-R-TRIM-A14-#-16-LED-**-**#-###-**-CRISP

Model Number	Additional Model Number	Additional Model Number
HORNET-HP-R/SR-FRAME-#-###-/HORNET-HP-R-TRIM-A14-#-18-LED-**-**#-###-**-2700-92	HORNET-HP-R/SR-FRAME-#-###-/HORNET-HP-R-TRIM-A14-#-18-LED-**-**#-###-**-3000-92	HORNET-HP-R/SR-FRAME-#-###-/HORNET-HP-R-TRIM-A14-#-18-LED-**-**#-###-**-3000
	HORNET-HP-R/SR-FRAME-#-###-/HORNET-HP-R-TRIM-A14-#-18-LED-**-**#-###-**-2700	HORNET-HP-R/SR-FRAME-#-###-/HORNET-HP-R-TRIM-A14-#-18-LED-**-**#-###-**-3500
	HORNET-HP-R/SR-FRAME-#-###-/HORNET-HP-R-TRIM-A14-#-18-LED-**-**#-###-**-3000	HORNET-HP-R/SR-FRAME-#-###-/HORNET-HP-R-TRIM-A14-#-18-LED-**-**#-###-**-4000