

HORNET® HP DOWNLIGHT

3.5" SQUARE DOWNLIGHT REMODELER TRIMLESS LED

APPLICATIONS:

Retail and commercial ambient lighting

CONSTRUCTION:

20 ga. galvanized steel frame
Cast aluminum plaster frame with perforated face
Die-cast optical housing
Extruded aluminum and die-cast heat sink

ELECTRICAL:

Electronic constant current LED driver, 120v or 277v input
ELV and Triac dimming standard, 120v or 277v.
Optional 0-10v or Lutron Hilume® dimming available. See following pages for details.

This product complies with IEEE C62.41 for surge endurance up to 2.5KV. Amerlux® recommends using additional surge protection with this unit (supplied by others), surge damage is not covered by warranty.

MOUNTING:

For use in sheet rock ceilings, typical ceiling thickness $\frac{5}{8}$ "

OPTICS:

LED:

Color Temp Options: 2200K, 2700K, 3000K, 3500K, 4000K
CRI: 83 typ. (2700K, 3000K, 3500K, 4000K)
90+ typ. (2200K, 2700K, 3000K)

Optional Amerlux CrispWhite technology (18W max)

R9 Value: 11 (83CRI), 55 (90+CRI)

Binning: 3 MacAdam (SDMC)

Lumen Maintenance: >70% of initial lumens @ 50,000 hrs
Lumen Output (at 3000K):

18W: SP 1175 typ.	20W: SP 1305 typ.
NF 1094 typ.	NF 1216 typ.
FL 1053 typ.	FL 1170 typ.
WF 1049 typ.	WF 1166 typ.

LABELING:

 approved to UL standards as tested by CSA.
For indoor use only
Damp location

HDL-HP-SD-
REM-A14-TL
LED



PROJECT:

TYPE:

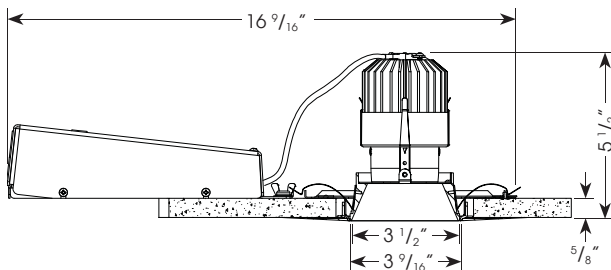

Celling Cut Out Dimension: $4\frac{1}{2}$ " x $4\frac{1}{2}$ " sq.

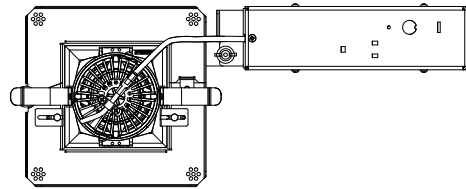

For 0-10V & Hilume dimming option

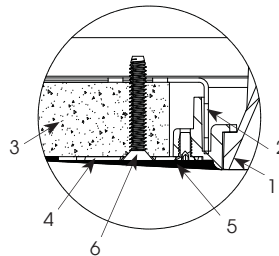

1. Reflector Trim
2. Fixture Housing Aperture Plate
3. Ceiling $\frac{5}{8}$ " (1" max)
4. Cast Aluminum Plaster Frame
5. Plaster Skim Coat (by others)
6. 6-32 Type F Thread Cutting Screw

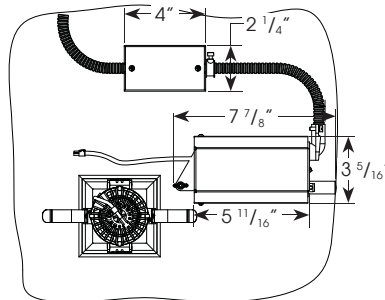

ELECTRICAL

Electronic driver

	13W		18W		20W	
	System Watts	Amps	System Watts	Amps	System Watts	Amps
120v	13	0.11	18	0.15	20	0.17
277v	13	0.05	18	0.06	20	0.07

ORDERING INFORMATION:

Housing: Model	Wattage	Lamp Type	Voltage	Options	Trim: Model	Aperture Finish	Beam Spread	Color Temp (CCT-CRI)	Options/ Accessories
HDL-HP-S-REM-A14-TL	13 18 20	LED	120 277	0-10V - 0-10v dimming HILUME - Lutron Hilume® dimming	HDL-HP-SD-A14-TL	MB - matte black MW - matte white SLV - matte silver	SP - spot, 15° NF - narrow flood, 20° MFL - medium flood, 24° FL - flood, 28° WF - wide flood, 45° VWF - very wide flood, 60° LS - linear spread, 60° x 10°	27 - 2700K-83 30 - 3000K-83 35 - 3500K-83 40 - 4000K-83 229 - 2200K-90+ 279 - 2700K-90+ 309 - 3000K-90+ CRISP - Crisp White (18W max)	HEX - hexcell louver SOL - solite beam softening lens

Complete Example: HDL-HP-S-REM-A14-TL-20-LED-120/HDL-HP-SD-A14-TL-MB-FL-30

Housing Example: HDL-HP-S-REM-A14-TL-20-LED-120

Reflector Example: HDL-HP-SD-A14-TL-MB-FL-30

Cat #:

Amerlux reserves the right to change details that do not affect overall function and performance.



HORNET® HP DOWNLIGHT

3.5" SQUARE DOWNLIGHT REMODELER TRIMLESS LED

HDL-HP-SD-
REM-A14-TL
LED



TYPE:



FIXTURE DATA: For 13W data, multiply by 0.71; For 18W data, multiply by 0.90

Complete photometric data (ies format) available upon request.

CCT Conversion Factor: 2700K-83 = 0.96; 3500K-83 = 1.02; 4000K-83 = 1.04; 2200K-90+ = 0.71; 2700-90+ = 0.80; 3000K-90+ = 0.83; CRISP = 0.65

20W LED 3000K-83

SPOT
DISTRIBUTION
LTL # 818202

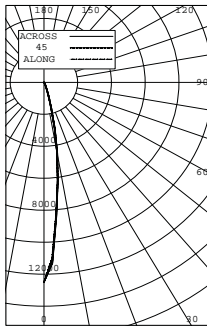

Candelas at Nadir	
Deg	Candela
0	12503
5	8267
15	1659
25	185
35	34
45	2

NARROW FLOOD
DISTRIBUTION
LTL # 818203

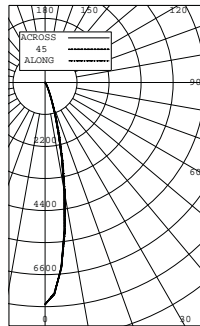

Candelas at Nadir	
Deg	Candela
0	7621
5	6414
15	1904
25	282
35	49
45	4

FLOOD
DISTRIBUTION
LTL # 818205

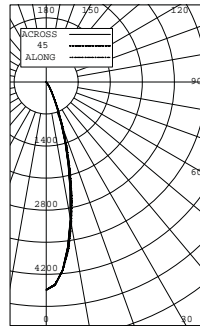

Candelas at Nadir	
Deg	Candela
0	4540
5	4130
15	2019
25	490
35	81
45	5

WIDE FLOOD
DISTRIBUTION
LTL # 818206

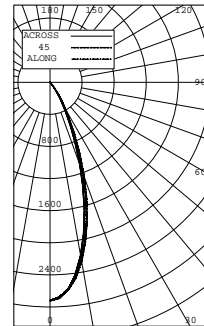

Candelas at Nadir	
Deg	Candela
0	2721
5	2581
15	1751
25	712
35	161
45	7

APPLICATION DATA:

Notes and Definitions:

Beam spread is to 50% center beam candlepower (CBCP).
 D=Distance to floor or wall.
 FC=Footcandles on floor or wall at center beam aiming location.
 L=Effective Visual Beam length in feet (50% of maximum footcandle level).
 W=Effective Visual Beam width in feet (50% of maximum footcandle level).
 CB=Distance across or down to center beam location.

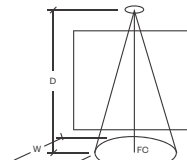

		0° Aiming Angle Horizontal Footcandles			
		D	FC	L	W
SPOT		5.0'	290	1.9	1.9
		7.5'	161	2.6	2.6
		10.0'	101	3.1	3.1
		12.5'	69	3.7	3.7
NARROW FLOOD		5.0'	219	2.2	2.2
		7.5'	114	3.0	3.0
		10.0'	69	3.8	3.8
		12.5'	45	4.7	4.7
FLOOD		5.0'	141	2.7	2.7
		7.5'	70	3.7	3.7
		10.0'	42	4.9	4.9
		12.5'	27	6.0	6.0
WIDE FLOOD		5.0'	97	3.3	3.3
		7.5'	46	4.8	4.8
		10.0'	26	6.3	6.3
		12.5'	17	7.7	7.7

HORNET® HP DOWNLIGHT

3.5" SQUARE DOWNLIGHT REMODELER TRIMLESS LED

HDL-HP-SD-
REM-A14-TL
LED



TYPE:



DIMMING COMPATIBILITY:

Amerlux® "Hornet" fixtures are compatible with all major dimming protocols prevalent in the United States. Please see below for general compatibilities and wiring diagrams. Amerlux recommends testing your unique dimming configuration as the exact full configuration (Dimmer, Fixture Quantity, Voltage, etc) may affect dimming performance.

TRIAC (Forward Phase) DIMMING (standard)

Utilizes "Standard" incandescent dimmers that are in wide use in installations across the US. Best for retrofit applications where Triac dimmers are installed.

Notes:

- 120v or 277v
- Dims down to less than 5% light output (most cases)
- Consult Dimming manufacturer for installation instructions - DO NOT SHARE NEUTRALS!
- Must meet dimmer Minimum Load Requirements per dimming manufacturer

Wiring Diagram

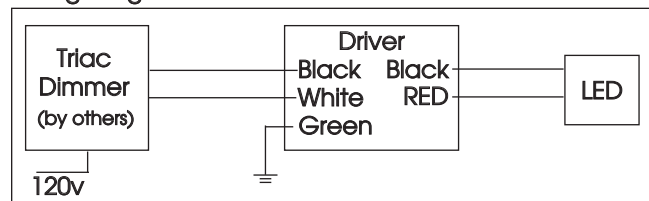

Compatible Dimmers

Wall Box (Incandescent Style, Wattage as required)

Lutron "Diva"
Lutron "Nova-T"
Lutron "Maestro"

Lutron "Vareo"
Lutron "Skylark"

Central System

ETC "SR" Rack w/D20
Module
Lutron "GP" Panel

ETC "DRD" Rack w/D20
Module
Lutron Grafix Eye QS

ELV - Electronic Low Voltage (Reverse Phase) DIMMING (standard)

Utilizes specialized "ELV" dimmers. Best for New Construction applications

Notes:

- 120v or 277v
- Dims down to less than 5% light output (most cases)
- Consult Dimming manufacturer for installation instructions - DO NOT SHARE NEUTRALS!
- Must meet dimmer Minimum Load Requirements

Wiring Diagram

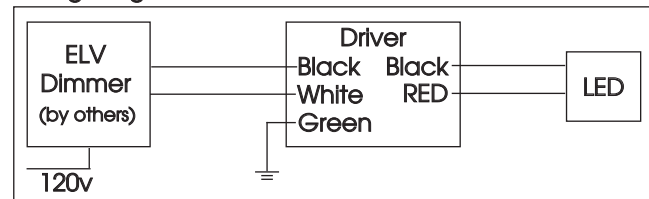

Compatible Dimmers

Wall Box (ELV Style)

Lutron "Diva"
Lutron "Nova-T"
Lutron "Maestro"
Leviton "Surslide"

Lutron "Vareo"
Lutron "Skylark"

Leviton "Vizio"

Central System

ETC "SR" Rack w/ELV10
Module
Lutron "GP" Panel with
PHPM-PA Interface

ETC "DRD" Rack w/ELV10
Module
Lutron Grafix Eye QS with
PHPM-PA Interface

HORNET® HP DOWNLIGHT

3.5" SQUARE DOWNLIGHT REMODELER TRIMLESS LED

HDL-HP-SD-
REM-A14-TL
LED



TYPE:



0-10V - DIMMING (-0-10V Option)

Integrates into a variety of building management and daylighting controls

Notes:

- 120v - 277v
- Dims down to 1% light output
- Requires interface to turn off power to driver
- Consult Dimming manufacturer for installation instructions - DO NOT SHARE NEUTRALS!

Wiring Diagram

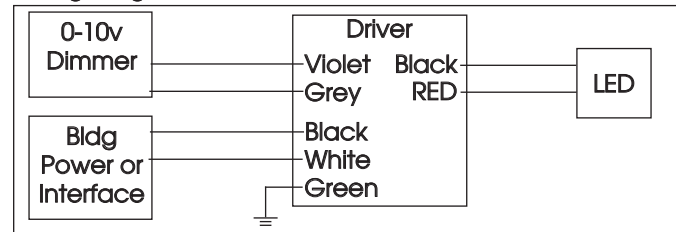

Compatible Dimmers

Wall Box

Lutron "Diva" - DVTV with PP-120H Interface

Leviton Renoir II 0-10v

Central System

Lutron Grafix Eye with GRX-TVI Interface

LUTRON HI-LUME / ECO-SYSTEM (-HILUME Option)

Integrates into a variety of building management and daylighting controls

Notes:

- 120v or 277v
- Dims down to less than 5% light output
- May use 3-Wire or Ecosystem Control
- Consult Dimming manufacturer for installation instructions - DO NOT SHARE NEUTRALS!

3-Wire Wiring Diagram

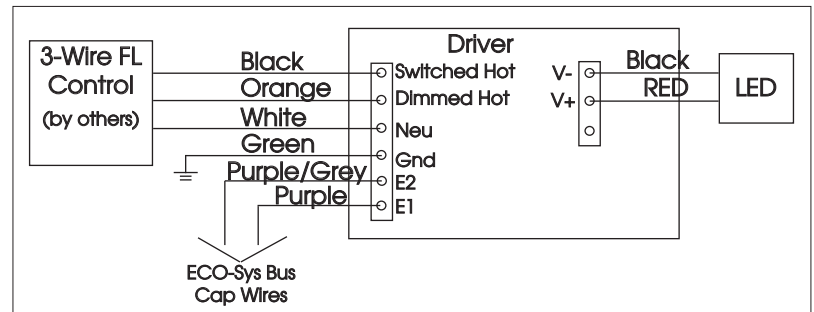

Compatible Dimmers

Wall Box (3-Wire Fluorescent)

DIVA
Maestro
Nova T
Vareo

Central System

Lutron ECO-System compatible controls
ETC "SR" Rack w/D20F Module
ETC "DRD" Rack w/D20F Module

ECO System Digital Control Wiring

