

# HORNET® HP DOWNLIGHT

3.5" SQUARE PINHOLE ADJUSTABLE REMODELER TRIMLESS LED

## APPLICATIONS:

Retail and commercial accent & display lighting

## CONSTRUCTION:

20 ga. galvanized steel frame  
Cast aluminum plaster frame with perforated face  
Die-cast optical housing  
Extruded aluminum and die-cast heat sink  
Formed steel faceplate

## ELECTRICAL:

Electronic constant current LED driver, 120v or 277v input  
ELV and Triac dimming standard, 120v or 277v,  
Optional 0-10v or Lutron Hilume® dimming available. See  
following pages for details.

**This product complies with IEEE C62.41 for surge endurance up to 2.5KV. Amerlux® recommends using additional surge protection with this unit (supplied by others), surge damage is not covered by warranty.**

## MOUNTING:

For use in sheet rock ceilings, typical ceiling thickness 5/8"

## OPTICS:

LED:

Color Temp Options: 2200K, 2700K, 3000K, 3500K, 4000K  
CRI: 83 typ. (2700K, 3000K, 3500K, 4000K)  
90+ typ. (2200K, 2700K, 3000K)

Optional Amerlux CrispWhite technology (18W max)

R9 Value: 11 (83CRI), 55 (90+CRI)

Binning: 3 MacAdam (SDMC)

Lumen Maintenance: >70% of initial lumens @ 50,000 hrs  
Lumen Output (at 3000K):

18W:SP 1063 typ	20W:SP 1181 typ
NF 963 typ	NF 1070 typ
MFL 909 typ	MFL 1010 typ
FL 862 typ	FL 958 typ

0-20° lockable tilt, 358° rotation

## LABELING:



approved to UL standards as tested by CSA.

For indoor use only

Damp location

HDL-HP-SPA-  
REM-A14-TL  
LED



PROJECT:

TYPE:

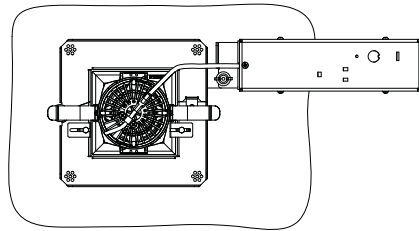
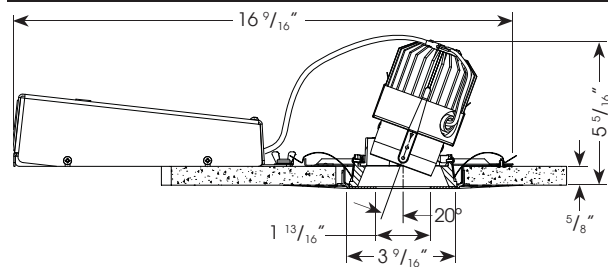

Ceiling Cut Out Dimension: 4 1/2" x 4 1/2" sq.

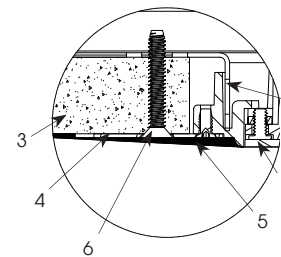

1. Faceplate
2. Fixture Housing Aperture Plate
3. Ceiling 5/8" (1" max)
4. Cast Aluminum Plaster Frame
5. Plaster Skim Coat (by others)
6. 6-32 Type F Thread Cutting Screw

For 0-10V & Hilume dimming option

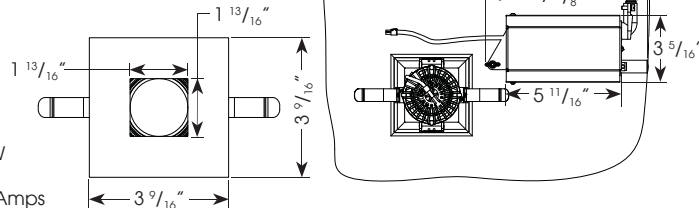

## ELECTRICAL

Electronic driver

	13W		18W		20W	
	System Watts	Amps	System Watts	Amps	System Watts	Amps
120v	13	0.11	18	0.15	20	0.17
277v	13	0.05	18	0.06	20	0.07

## ORDERING INFORMATION:

Housing: Model	Wattage	Lamp Type	Voltage	Options	Trim: Model	Trim Finish	Beam Spread	Color Temp (CCT-CRI)	Options/Accessories
HDL-HP-R-REM-A14-TL	13 18 20	LED	120 277	0-10V - 0-10v dimming HILUME - Lutron Hilume® dimming	HDL-HP-RPA-A14-TL	MW - matte white MB - matte black SLV - matte silver PC - polished chrome BSS - brushed stainless steel	SP - spot, 15° NF - narrow flood, 20° MFL - medium flood, 24° FL - flood, 28°	27 - 2700K-83 30 - 3000K-83 35 - 3500K-83 40 - 4000K-83  229 - 2200K-90+ 279 - 2700K-90+ 309 - 3000K-90+	HEX - hexcell louver SOL - solite beam softening lens

CRISP - CrispWhite (18W max)

Complete Example: HDL-HP-S-REM-A14-TL-20-LED-120/HDL-HP-SPA-A14-TL-MW-FL-30

Housing Example: HDL-HP-S-REM-A14-TL-20-LED-120

Reflector Example: HDL-HP-SPA-A14-TL-MW-FL-30

Cat #:

Amerlux reserves the right to change details that do not affect overall function and performance.



(see website for details)

# HORNET® HP DOWNLIGHT

3.5" SQUARE PINHOLE ADJUSTABLE REMODELER TRIMLESS LED

HDL-HP-SPA-  
REM-A14-TL  
LED



TYPE:



**FIXTURE DATA:** For 13W data, multiply by 0.71; For 18W data, multiply by 0.90

Complete photometric data (ies format) available upon request.

CCT Conversion Factor: 2700K-83 = 0.96; 3500K-83 = 1.02; 4000K-83 = 1.04; 2200K-90+ = 0.71; 2700-90+ = 0.80; 3000K-90+ = 0.83; CRISP = 0.65

## 20W LED 3000K-83

SPOT  
DISTRIBUTION  
LTL # 818198

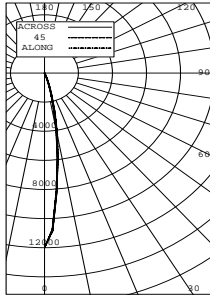

Candelas at Nadir	
Deg	Candela
0	11999
5	8118
15	1462
25	65
35	6
45	0

NARROW FLOOD  
DISTRIBUTION  
LTL # 818199

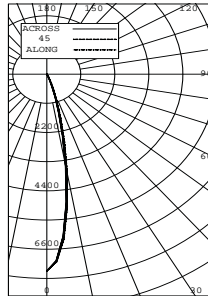

Candelas at Nadir	
Deg	Candela
0	7421
5	6260
15	1564
25	126
35	11
45	1

MEDIUM FLOOD  
DISTRIBUTION  
LTL # 818200

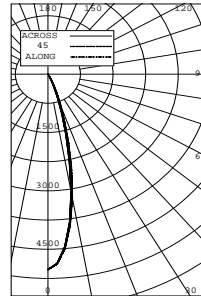

Candelas at Nadir	
Deg	Candela
0	5022
5	4486
15	1651
25	210
35	12
45	0

FLOOD  
DISTRIBUTION  
LTL # 818201

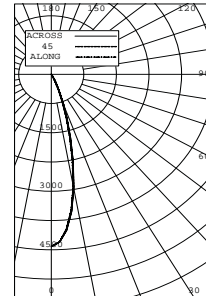

Candelas at Nadir	
Deg	Candela
0	4416
5	3999
15	1623
25	218
35	12
45	0

## APPLICATION DATA:

### Notes and Definitions:

- Beam spread is to 50% center beam candlepower (CBCP).
- D=Distance to floor or wall.
- FC=Footcandles on floor or wall at center beam aiming location.
- L=Effective Visual Beam length in feet (50% of maximum footcandle level).
- W=Effective Visual Beam width in feet (50% of maximum footcandle level).
- CB=Distance across or down to center beam location.

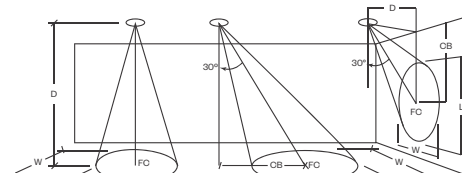

0° Aiming Angle  
Horizontal  
Footcandles

	D	FC	L	W
SPOT	5.0'	278	1.8	1.8
	7.5'	156	2.5	2.5
	10.0'	97	3.1	3.1
	12.5'	66	3.6	3.6
NARROW FLOOD	5.0'	212	2.1	2.1
	7.5'	111	2.9	2.9
	10.0'	67	3.6	3.6
	12.5'	44	4.5	4.4
MEDIUM FLOOD	5.0'	167	2.4	2.3
	7.5'	82	3.3	3.2
	10.0'	48	4.3	4.2
	12.5'	31	5.3	5.2
FLOOD	5.0'	143	2.5	2.5
	7.5'	71	3.4	3.5
	10.0'	41	4.5	4.6
	12.5'	27	5.5	5.6

# HORNET® HP DOWNLIGHT

3.5" SQUARE PINHOLE ADJUSTABLE REMODELER TRIMLESS LED

HDL-HP-SPA-  
REM-A14-TL  
LED



TYPE:



**DIMMING COMPATIBILITY:**

Amerlux® "Hornet" fixtures are compatible with all major dimming protocols prevalent in the United States. Please see below for general compatibilities and wiring diagrams. Amerlux recommends testing your unique dimming configuration as the exact full configuration (Dimmer, Fixture Quantity, Voltage, etc) may affect dimming performance.

**TRIAC (Forward Phase) DIMMING (standard)**

Utilizes "Standard" incandescent dimmers that are in wide use in installations across the US. Best for retrofit applications where Triac dimmers are installed.

**Notes:**

- 120v or 277v
- Dims down to less than 5% light output (most cases)
- Consult Dimming manufacturer for installation instructions - DO NOT SHARE NEUTRALS!
- Must meet dimmer Minimum Load Requirements per dimming manufacturer

**Wiring Diagram**

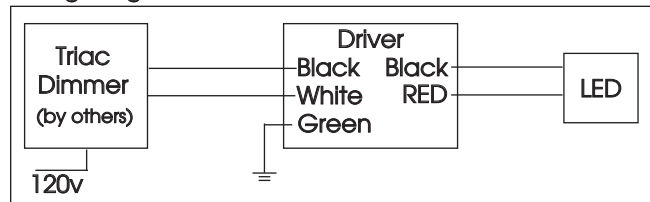

**Compatible Dimmers**

**Wall Box (Incandescent Style, Wattage as required)**

Lutron "Diva"  
Lutron "Nova-T"  
Lutron "Maestro"

Lutron "Vareo"  
Lutron "Skylark"

**Central System**

ETC "SR" Rack w/D20  
Module  
Lutron "GP" Panel

ETC "DRD" Rack w/D20  
Module  
Lutron Grafix Eye QS

**ELV - Electronic Low Voltage (Reverse Phase) DIMMING (standard)**

Utilizes specialized "ELV" dimmers. Best for New Construction applications

**Notes:**

- 120v or 277v
- Dims down to less than 5% light output (most cases)
- Consult Dimming manufacturer for installation instructions - DO NOT SHARE NEUTRALS!
- Must meet dimmer Minimum Load Requirements

**Wiring Diagram**

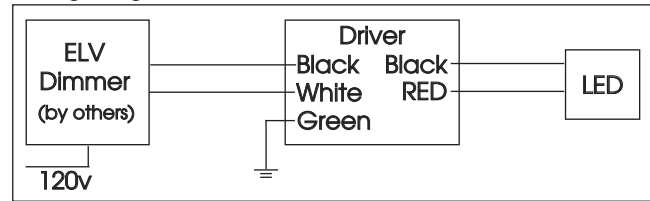

**Compatible Dimmers**

**Wall Box (ELV Style)**

Lutron "Diva"  
Lutron "Nova-T"  
Lutron "Maestro"  
Leviton "Surslide"

Lutron "Vareo"  
Lutron "Skylark"  
  
Leviton "Vizio"

**Central System**

ETC "SR" Rack w/ELV10  
Module  
Lutron "GP" Panel with  
PHPM-PA Interface

ETC "DRD" Rack w/ELV10  
Module  
Lutron Grafix Eye QS with  
PHPM-PA Interface

# HORNET® HP DOWNLIGHT

3.5" SQUARE PINHOLE ADJUSTABLE REMODELER TRIMLESS LED

HDL-HP-SPA-REM-A14-TL LED



TYPE:



## 0-10V - DIMMING (-0-10V Option)

Integrates into a variety of building management and daylighting controls

### Notes:

- 120v - 277v
- Dims down to 1% light output
- Requires interface to turn off power to driver
- Consult Dimming manufacturer for installation instructions - DO NOT SHARE NEUTRALS!

### Wiring Diagram

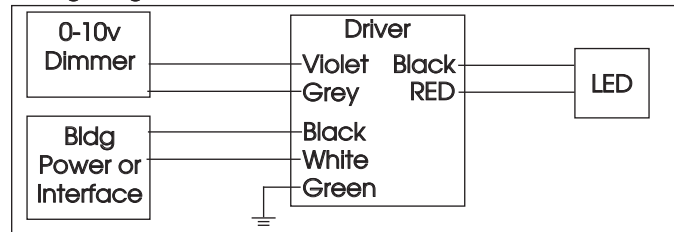

### Compatible Dimmers

#### Wall Box

Lutron "Diva" - DVTV with PP-120H Interface

Leviton Renoir II 0-10v

#### Central System

Lutron Grafix Eye with GRX-TVI Interface

## LUTRON HI-LUME / ECO-SYSTEM (-HILUME Option)

Integrates into a variety of building management and daylighting controls

### Notes:

- 120v or 277v
- Dims down to less than 5% light output
- May use 3-Wire or Ecosystem Control
- Consult Dimming manufacturer for installation instructions - DO NOT SHARE NEUTRALS!

### 3-Wire Wiring Diagram

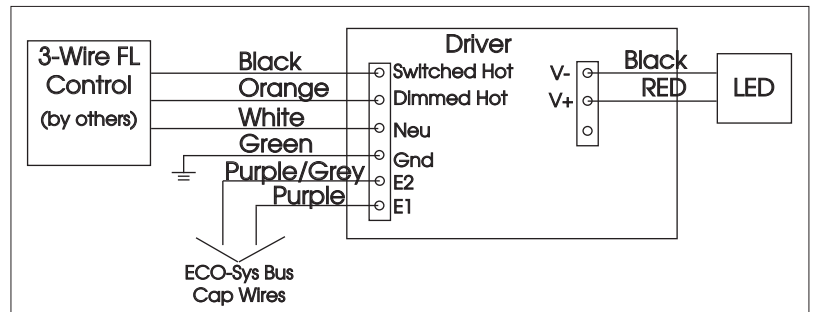

### Compatible Dimmers

#### Wall Box (3-Wire Fluorescent)

DIVA  
Maestro  
Nova T  
Vareo

#### Central System

Lutron ECO-System compatible controls  
ETC "SR" Rack w/D20F Module  
ETC "DRD" Rack w/D20F Module

### ECO System Digital Control Wiring

