

GRÜV® 4" HIGH EFFICIENCY

RECESSED LINEAR FLANGED LED

APPLICATION:

Retail and commercial recessed ambient lighting

CONSTRUCTION:

Steel housing
Extruded aluminum ceiling trim
Die-formed, cold-rolled steel internal components and external housing

ELECTRICAL:

Electronic, multi-volt (120v-277v) constant current driver
Dimmable, 0-10v (not on 2' or 3' lengths at 5w/ft)
5w/ft - 1 LED driver per 8', 10w/ft - 1 LED driver per 4'
This product complies with IEEE C62.41 for surge endurance up to 3KV. Amerlux® recommends using additional surge protection with this unit (supplied by others), surge damage is not covered by warranty
Emergency circuit via remote inverter or auxiliary emergency power supply (by others)

LABELING:



For indoor use only

OPTICS:

5w/ft or 10w/ft
Color Temp: 2700K, 3000K, 3500K, 4000K
CRI: 80 typ
Life: 50,000 hrs
Lumen Maintenance: >70% of initial lumens @ 50,000 hrs
Lumen Output (perf lens, 3500K): 443 lm/ft (5w)
809 lm/ft (10w)

Extruded white acrylic lens, snap-in, 8' maximum section
Amerlux exclusive white acrylic lens provides excellent transmission while effectively concealing lamp image
Specify either Designer Lens (DL), which provides flat even glow on lens or Performance Lens (PL), which provides higher efficiency with a greater linear hot spot on lens. Designer Lens is standard

MOUNTING:

For use in gypsum board or wood ceilings
For individual or continuous row applications
Fixture installed before ceiling

GRÜV4-HE-FLANGE LED



PROJECT:

TYPE:

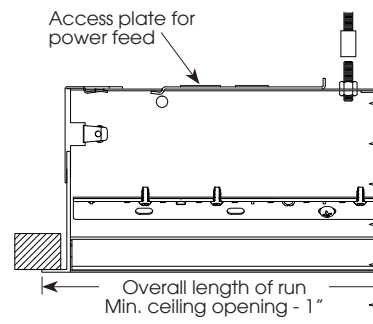
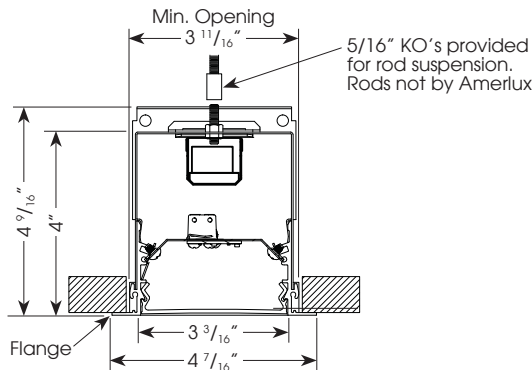

ELECTRICAL

Driver	Wattage per foot	Lamping				
		4'		8'		
		System watts	Amps	System watts	Amps	
Electronic	5	120v	21.7	0.18	43.8	0.36
		277v	24.1	0.10	44.6	0.16
	10	120v	47.3	0.39	94.6	0.78
		277v	47.6	0.18	95.2	0.36

ORDERING INFORMATION:

Model	Lens	Wattage Per Foot	Lamp Type	Color Temp	Finish	Voltage	Length	Configuration	Options/Accessories
GRUV4-HE-FLANGE	DL - designer lens (standard)	5	LED	2700	HW - high reflectance white	120/277	2 - 2'	IND - individual	HILUME-DH - Lutron Hi-lume® 3 wire, 1% dim
	PL - performance lens	10		3000			3 - 3'		
				3500			4 - 4'	MOR - middle of run	
				4000			5 - 5'	EOR - end of run	
							6 - 6'		CP - Chicago Plenum
							7 - 7'		ENLS - Enlighted Sensor
							8 - 8'		
							— - continuous run (consult factory)		

*Note - For 10w fixtures - Due to driver limitations, not all output & length configurations are possible. Please consult factory.

Example: GRUV4-HE-FLANGE-DL-5-LED-3500-HW-120/277-4-IND

Cat #:

Amerlux reserves the right to change details that do not affect overall function and performance.



Enlighted Sensor (optional)

10 year limited warranty
AMERLUX LED

(see website for details)

GRÜV® 4" HIGH EFFICIENCY

RECESSED LINEAR FLANGED LED

GRÜV4-HE-
FLANGE
LED



TYPE:



INDIVIDUAL FIXTURE LENGTHS:

* Note: 2' & 3' lengths are not dimmable at 5w/ft

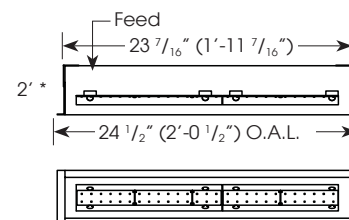
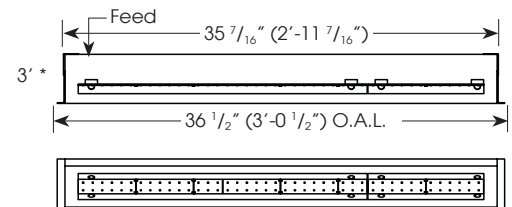
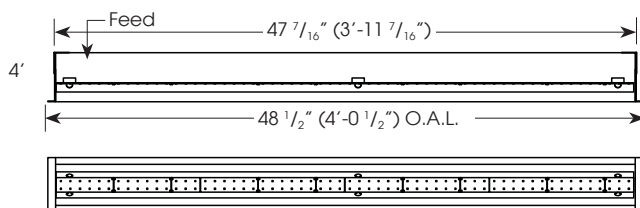
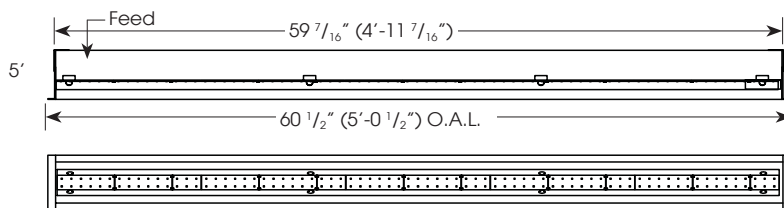
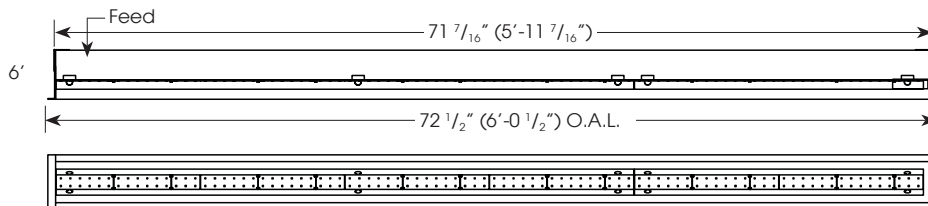
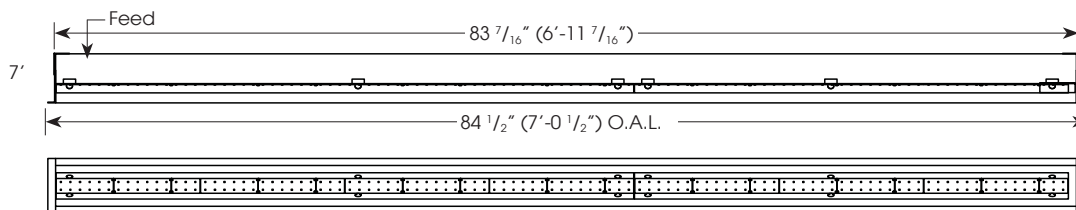
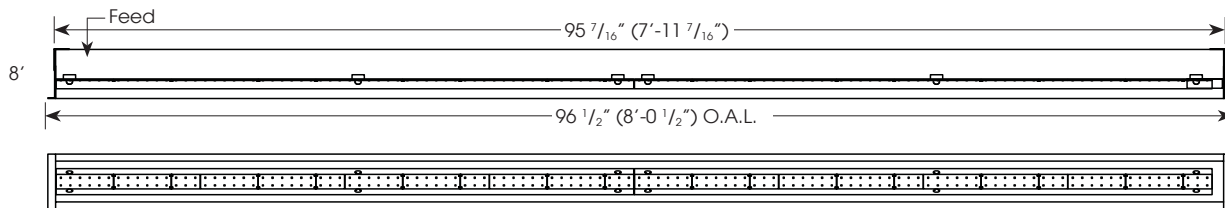

GRÜV® 4" HIGH EFFICIENCY

RECESSED LINEAR FLANGED LED

GRÜV4-HE-
FLANGE
LED



TYPE:



STANDARD PLACEMENT(S) FOR (OPTIONAL) ENLIGHTENED SENSOR:

4 FT OR 8 FT DIRECT

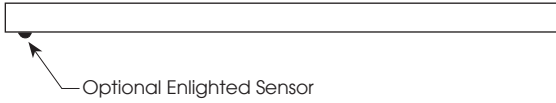

RUNS

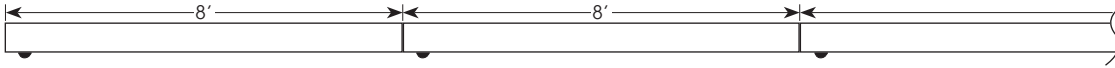

GRÜV® 4" HIGH EFFICIENCY

RECESSED LINEAR FLANGED LED

GRÜV4-HE-
FLANGE
LED



TYPE:



FIXTURE DATA:

Complete photometric data (.ies format) available upon request.

PERFORMANCE LENS

GRÜV HE 5W LED 4FT 3500K
SOURCE: 120 WHITE LEDS LUMENS: 1771
RECESSED

GRÜV HE 10W LED 4FT 3500K
SOURCE: 120 WHITE LEDS LUMENS: 3234
RECESSED

LTL# 491075

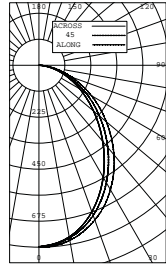

ZONAL LUMEN SUMMARY

Zone	Lumens	%Fixt
0-30	576	32.51
0-40	904	51.08
0-60	1472	83.11
0-90	1771	100.00
40-90	866	48.92
60-90	299	16.89
90-180	0	0.00
0-180	1771	100.00

Total Luminaire Efficiency = 82.7 Lumens /Watt

COEFFICIENTS OF UTILIZATION

Effective Floor Cavity Reflectance 20%

RC	80			
RW	70	50	30	10
RCR				
0	1.19	1.19	1.19	1.19
1	1.10	1.06	1.03	0.99
2	1.02	0.95	0.89	0.84
3	0.94	0.85	0.78	0.72
4	0.87	0.77	0.69	0.63
5	0.81	0.69	0.61	0.55
6	0.75	0.63	0.54	0.49
7	0.69	0.56	0.48	0.43
8	0.64	0.51	0.44	0.38
9	0.60	0.47	0.39	0.34
10	0.56	0.43	0.35	0.30

LTL# 491076

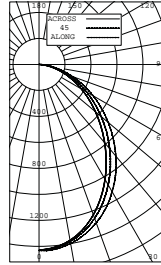

ZONAL LUMEN SUMMARY

Zone	Lumens	%Fixt
0-30	1049	32.43
0-40	1648	50.98
0-60	2686	83.05
0-90	3234	100.00
40-90	1585	49.02
60-90	548	16.95
90-180	0	0.00
0-180	3234	100.00

Total Luminaire Efficiency = 76.5 Lumens /Watt

COEFFICIENTS OF UTILIZATION

Effective Floor Cavity Reflectance 20%

RC	80			
RW	70	50	30	10
RCR				
0	1.19	1.19	1.19	1.19
1	1.10	1.06	1.03	0.99
2	1.02	0.95	0.89	0.84
3	0.94	0.85	0.78	0.72
4	0.87	0.77	0.69	0.63
5	0.81	0.69	0.61	0.55
6	0.75	0.62	0.54	0.49
7	0.69	0.56	0.48	0.43
8	0.64	0.51	0.44	0.38
9	0.60	0.47	0.39	0.34
10	0.56	0.43	0.35	0.30

DESIGNER LENS

GRÜV HE 5W LED 4FT 3500K
SOURCE: 120 WHITE LEDS LUMENS: 1113
RECESSED

GRÜV HE 10W LED 4FT 3500K
SOURCE: 120 WHITE LEDS LUMENS: 2053
RECESSED

LTL# 289630

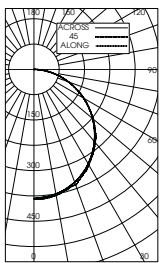

ZONAL LUMEN SUMMARY

Zone	Lumens	%Fixt
0-30	298	26.76
0-40	487	43.75
0-60	861	77.42
0-90	1113	99.98
40-90	626	56.23
60-90	251	22.56
90-180	0	0.02
0-180	1113	100.00

Total Luminaire Efficiency = 51.7 Lumens /Watt

COEFFICIENTS OF UTILIZATION

Effective Floor Cavity Reflectance 20%

RC	80			
RW	70	50	30	10
RCR				
0	1.19	1.19	1.19	1.19
1	1.09	1.05	1.00	0.97
2	1.00	0.92	0.86	0.80
3	0.91	0.81	0.73	0.67
4	0.84	0.73	0.64	0.58
5	0.77	0.65	0.56	0.50
6	0.71	0.58	0.49	0.43
7	0.65	0.52	0.43	0.38
8	0.61	0.47	0.39	0.33
9	0.56	0.43	0.35	0.29
10	0.52	0.39	0.31	0.26

LTL# 289631

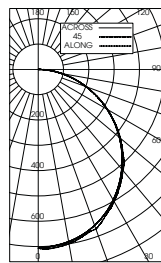

ZONAL LUMEN SUMMARY

Zone	Lumens	%Fixt
0-30	549	26.73
0-40	897	43.71
0-60	1588	77.35
0-90	2052	99.97
40-90	1115	56.26
60-90	464	22.62
90-180	1	0.03
0-180	2053	100.00

Total Luminaire Efficiency = 47.1 Lumens /Watt

COEFFICIENTS OF UTILIZATION

Effective Floor Cavity Reflectance 20%

RC	80			
RW	70	50	30	10
RCR				
0	1.19	1.19	1.19	1.19
1	1.09	1.04	1.00	0.97
2	1.00	0.92	0.86	0.80
3	0.91	0.81	0.73	0.67
4	0.84	0.73	0.64	0.58
5	0.77	0.65	0.56	0.50
6	0.71	0.58	0.49	0.43
7	0.65	0.52	0.43	0.38
8	0.61	0.47	0.39	0.33
9	0.56	0.43	0.35	0.29
10	0.52	0.39	0.31	0.26