

CYLINDRIX® III MINI

MULTIPLE SEMI-RECESSED 1 LIGHT LED

C3MSR-1
1LT LED

APPLICATION:

Accent and display lighting for retail, commercial and hospitality environments

CONSTRUCTION:

Stamped steel mounting frame with integral mounting bars
Thermally protected
Steel driver housing
Steel upper housing and laser cut trim ring
Complete die-cast optical head construction
Powder coat paint

MOUNTING:

For use in T-grid or sheetrock ceilings, max thickness 1" standard, consult factory for thicker ceilings

LABELING:



For indoor use only

OPTICS:

0-40° tilt, 360°+ rotation
Available in a variety of beam spreads
LED:
Color Temp Options: 2200K, 2700K, 3000K, 3500K, 4000K
CRI: 83 typ. (2700K, 3000K, 3500K, 4000K)
90+ typ. (2200K, 2700K, 3000K, 3500K)
CrispWhite LED available
R9 Values: 11 (83CRI), 55 (90+CRI)
Binning: 3 MacAdam
Lumen Maintenance: >70% of initial lumens @ 50,000 hrs
Lumen Output (21w, 3000K): 1850 lm (89.6 lpw)
CBCP (21w, 3000K): SP 13,578

ELECTRICAL:

Electronic constant current LED driver, 120v - 277v input
ELV and Triac dimming standard, 120v & 277v.
0-10v and Lutron systems also available. See following pages for more information.

This product complies with IEEE C62.41 for surge endurance up to 2.5KV. Amerlux® recommends using additional surge protection with this unit (supplied by others), surge damage is not covered by warranty.



PROJECT:

TYPE:

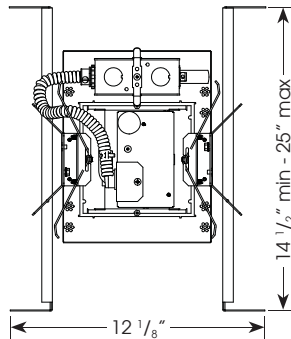

Ceiling Cut Out Dimension: 5 9/16" x 5 9/16"

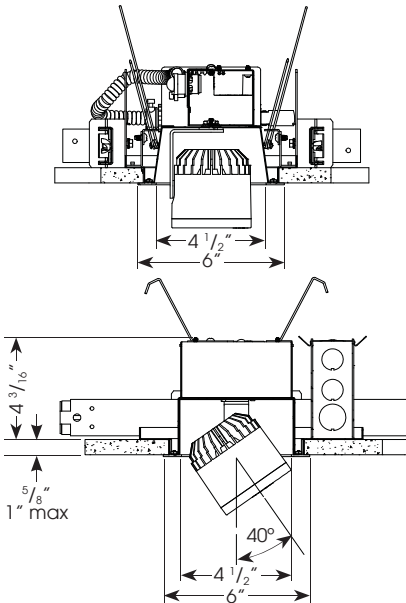

Electrostatic sensitive device,
observe precautions for
handling

ELECTRICAL

Electronic driver

	15w		18w		21w	
	System Watts	Amps	System Watts	Amps	System Watts	Amps
120v	15	0.13	18	0.15	21	0.18
277v	15	0.05	18	0.06	21	0.08

ORDERING INFORMATION:

FRAME Model	# Heads	Lamp Type	Voltage	Options/Accessories
C3MR/SR-FRAME	1	LED	120 277	0-10V - 0-10v dimming HILUME - Lutron Hi-Lume® dimming DALI - DALI dimming CP - Chicago plenum

Complete Unit Specification:

C3MR/SR-FRAME-1-LED-120/C3MSR-TRIM-1-21-LED-WT-120-277-SP-WT-30

Frame Only: C3MR/SR-FRAME-1-LED-120

Trim Only: C3MSR-TRIM-1-21-LED-WT-120-277-SP-WT-30

TRIM Model	# Heads	Wattage	Lamp Type	Housing/Head Finish	Voltage	Beam Spread	Trim Finish	Color Temp (CCT-CRI)	Options/Accessories
C3MSR-TRIM	1	15	LED	WT - white texture BT - black texture ST - silver texture	120-277	SP - spot, 14° VNF - very narrow flood, 18° NF - narrow flood, 23° FL - flood, 34° WF - wide flood, 44°	WT - white texture BT - black texture ST - silver texture	27 - 2700-83 30 - 3000-83 35 - 3500-83 40 - 4000-83 229 - 2200-90+ 279 - 2700-90+ 309 - 3000-90+ 359 - 3500-90+ 409 - 4000-90+ 3CLA - 3K Class A CRISP - CrispWhite (not for VNSP)	SN- snoot, 1" w/black matte interior standard HEX - hexcell louver LS - linear spread CB - cross blade, matte black, requires snoot SOL - solite beam softening lens 0-10V - 0-10v dimming HILUME - Lutron Hi-Lume® dimming DALI - DALI driver CP - Chicago plenum
		21							

Cat #:

Amerlux reserves the right to change details that do not affect overall function and performance.



CYLINDRIX® III MINI

MULTIPLE SEMI-RECESSED 1 LIGHT LED

C3MSR-1
1LT LED



TYPE:



FIXTURE DATA: For 15W data, multiply by 0.71; For 18W data see next page

Complete photometric data (ies format) available upon request.

CCT Correction Factors: 2700-83 = 0.96; 3500-83 = 1.02; 4000-83 = 1.04; 2200-90+ = 0.71; 2700-90+ = 0.80; 3000-90+ = 0.83; 3500-90+ = 0.87; Crisp = 0.65

21W LED (3000K)

SPOT (SP)
DISTRIBUTION
LTL #1026701

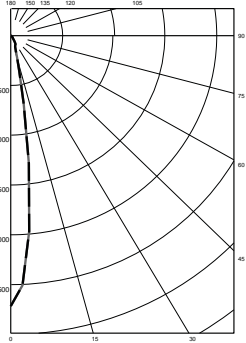

Candelas at Nadir	
Deg	Candela
0	13578
5	9865
15	1152
25	506
35	211
45	101

VERY NARROW
FLOOD (VNF) DISTRIBUTION
LTL #883522

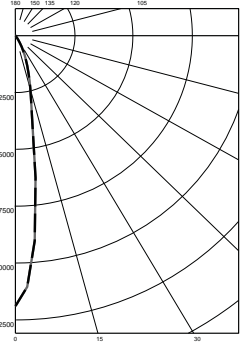

Candelas at Nadir	
Deg	Candela
0	11895
5	9054
15	2337
25	790
35	103
45	23

NARROW FLOOD (NF)
DISTRIBUTION
LTL #1037438

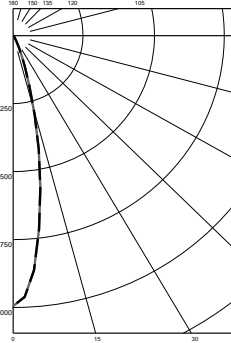

Candelas at Nadir	
Deg	Candela
0	8953
5	7795
15	2707
25	474
35	94
45	50

FLOOD (FL)
DISTRIBUTION
LTL #1037439

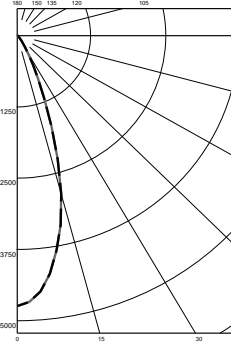

Candelas at Nadir	
Deg	Candela
0	4743
5	4504
15	2871
25	829
35	178
45	49

WIDE FLOOD (WF)
DISTRIBUTION
LTL #1037440

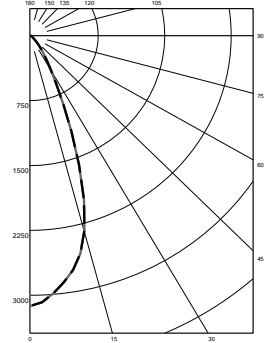

Candelas at Nadir	
Deg	Candela
0	3124
5	2988
15	2330
25	876
35	287
45	102

APPLICATION DATA:

Notes and Definitions:

Beam spread is to 50% center beam candlepower (CBCP).
 D=Distance to floor or wall.
 FC=Footcandles on floor or wall at center beam aiming location.
 L=Effective Visual Beam length in feet (50% of maximum footcandle level).
 W=Effective Visual Beam width in feet (50% of maximum footcandle level).
 CB=Distance across or down to center beam location.

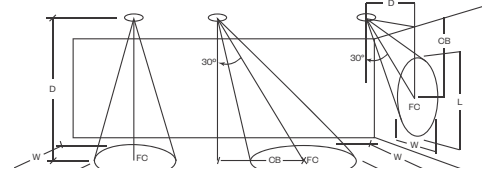

0° Aiming Angle
Horizontal
Footcandles



30° Aiming Angle
Horizontal
Footcandles



30° Aiming Angle
Vertical
Footcandles



60° Aiming Angle
Vertical
Footcandles

	0° Aiming Angle Horizontal Footcandles				30° Aiming Angle Horizontal Footcandles					30° Aiming Angle Vertical Footcandles					60° Aiming Angle Vertical Footcandles				
	D	FC	L	W	D	FC	L	W	CB	D	FC	L	W	CB	D	FC	L	W	CB
SPOT	5.0'	540	1.2	1.2	5.0'	348	1.6	1.4	3.0	3.0'	200	2.8	1.4	5.0	3.0'	726	1.3	1.1	2.0
	7.5'	241	1.8	1.8	7.5'	155	2.5	2.2	4.0	4.0'	121	3.5	1.8	6.0	4.0'	518	1.5	1.2	2.0
	10.0'	136	2.6	2.6	10.0'	85	3.4	3.0	6.0	5.0'	77	4.3	2.5	8.0	5.0'	334	1.8	1.3	3.0
	12.5'	87	3.2	3.2	12.5'	57	4.2	3.6	7.0	6.0'	54	5.2	2.9	9.0	6.0'	230	2.2	1.6	3.0
VERY NARROW FLOOD	5.0'	473	1.4	1.4	5.0'	305	1.9	1.5	3.0	3.0'	176	3.4	1.5	5.0	3.0'	651	1.6	1.2	2.0
	7.5'	211	2.1	2.1	7.5'	136	2.9	2.5	4.0	4.0'	108	4.1	2.0	6.0	4.0'	462	1.6	1.3	2.0
	10.0'	119	2.9	2.9	10.0'	75	3.8	3.3	6.0	5.0'	67	5.3	2.8	8.0	5.0'	293	2.0	1.5	3.0
	12.5'	76	3.5	3.5	12.5'	50	4.7	3.9	7.0	6.0'	49	6.3	3.2	9.0	6.0'	206	2.4	1.8	3.0
NARROW FLOOD	5.0'	358	1.9	1.9	5.0'	257	2.4	2.1	3.0	3.0'	181	3.2	1.8	4.0	3.0'	620	1.9	1.2	2.0
	7.5'	159	2.9	2.9	7.5'	115	3.5	3.2	4.0	4.0'	96	4.4	2.8	6.0	4.0'	426	1.9	1.5	2.0
	10.0'	90	3.8	3.8	10.0'	63	4.8	4.2	5.0	5.0'	63	5.3	3.3	7.0	5.0'	249	2.5	2.2	3.0
	12.5'	58	4.8	4.8	12.5'	40	6.1	5.4	7.0	6.0'	43	6.7	4.0	8.0	6.0'	182	2.9	2.6	3.0
FLOOD	5.0'	190	2.9	2.9	5.0'	130	3.5	3.1	2.0	3.0'	113	3.4	2.7	3.0	3.0'	340	2.3	1.8	1.0
	7.5'	85	4.3	4.3	7.5'	58	5.2	4.8	3.0	4.0'	64	4.6	3.5	4.0	4.0'	208	2.8	2.6	2.0
	10.0'	48	5.7	5.7	10.0'	34	6.8	6.4	5.0	5.0'	41	5.8	4.4	5.0	5.0'	133	3.5	3.1	2.0
	12.5'	31	7.2	7.2	12.5'	22	8.5	8.0	6.0	6.0'	29	7.0	5.2	7.0	6.0'	93	4.1	3.8	3.0
WIDE FLOOD	5.0'	125	3.3	3.3	5.0'	92	3.9	3.5	2.0	3.0'	92	3.2	2.7	3.0	3.0'	254	2.3	2.0	1.0
	7.5'	56	5.0	5.0	7.5'	41	5.6	5.4	3.0	4.0'	52	4.3	3.6	4.0	4.0'	138	3.2	3.0	2.0
	10.0'	32	6.7	6.7	10.0'	23	7.6	7.3	4.0	5.0'	34	5.3	4.6	5.0	5.0'	93	3.9	3.5	2.0
	12.5'	20	8.5	8.5	12.5'	15	9.6	9.2	5.0	6.0'	23	6.5	5.5	6.0	6.0'	64	4.7	4.5	2.0

CYLINDRIX® III MINI

MULTIPLE SEMI-RECESSED 1 LIGHT LED

C3MSR-1
1LT LED



TYPE:



FIXTURE DATA:

Complete photometric data (ies format) available upon request.

CCT Correction Factors: 2700-83 = 0.96; 3500-83 = 1.02; 4000-83 = 1.04; 2200-90+ = 0.71; 2700-90+ = 0.80; 3000-90+ = 0.83; 3500-90+ = 0.87; Crisp = 0.65

18W LED (3000K-83)

VERY NARROW SPOT (VNSP)
DISTRIBUTION
LTL #1170140

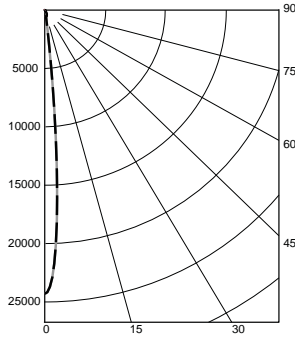

Candelas at Nadir	Deg	Candela
	0	24308
	5	8980
	15	527
	25	394
	35	131
	45	57

APPLICATION DATA:

Notes and Definitions:

Beam spread is to 50% center beam candlepower (CBCP).
 D=Distance to floor or wall.
 FC=Footcandles on floor or wall at center beam aiming location.
 L=Effective Visual Beam length in feet (50% of maximum footcandle level).
 W=Effective Visual Beam width in feet (50% of maximum footcandle level).
 CB=Distance across or down to center beam location.

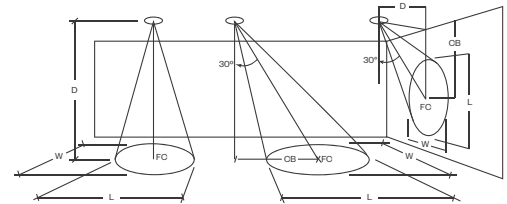

0° Aiming Angle
Horizontal
Footcandles



30° Aiming Angle
Horizontal
Footcandles



30° Aiming Angle
Vertical
Footcandles



60° Aiming Angle
Vertical
Footcandles

VERY NARROW SPOT	0° Aiming Angle Horizontal Footcandles				30° Aiming Angle Horizontal Footcandles					30° Aiming Angle Vertical Footcandles					60° Aiming Angle Vertical Footcandles				
	D	FC	L	W	D	FC	L	W	CB	D	FC	L	W	CB	D	FC	L	W	CB
	5.0'	967	1.0	1.0	5.0'	624	1.0	1.0	3.0	3.0'	360	1.5	1.0	5.0	3.0'	983	1.0	1.0	2.0
	7.5'	431	1.1	1.1	7.5'	251	1.8	1.1	4.0	4.0'	185	2.4	1.1	7.0	4.0'	729	1.1	1.0	2.0
	10.0'	243	1.3	1.3	10.0'	153	2.1	1.6	6.0	5.0'	129	2.7	1.2	8.0	5.0'	600	1.1	1.0	3.0
	12.5'	156	1.8	1.8	12.5'	102	2.4	2.2	7.0	6.0'	90	3.3	1.6	10.0	6.0'	325	1.9	1.0	3.0

CYLINDRIX® III MINI

MULTIPLE SEMI-RECESSED 1 LIGHT LED

C3MSR-1
1LT LED



TYPE:



DIMMING COMPATIBILITY:

Amerlux® fixtures are compatible with all major dimming protocols prevalent in the United States. Please see below for general compatibilities and wiring diagrams. Amerlux recommends testing your unique dimming configuration as the exact full configuration (Dimmer, Fixture Quantity, Voltage, etc) may affect dimming performance.

TRIAC (Forward Phase) DIMMING (standard)

Utilizes "Standard" incandescent dimmers that are in wide use in installations across the US. Best for retrofit applications where Triac dimmers are installed.

Notes:

- 120v & 277v
- Dims down to less than 5% light output (most cases)
- Consult Dimming manufacturer for installation instructions - DO NOT SHARE NEUTRALS!
- Must meet dimmer Minimum Load Requirements per dimming manufacturer

Wiring Diagram

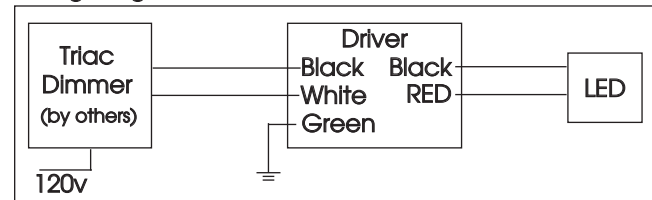

Compatible Dimmers

Wall Box (Incandescent Style, Wattage as required)

Lutron "Diva"	Lutron "Vareo"
Lutron "Nova-T"	Lutron "Skylark"
Lutron "Maestro"	

Central System

ETC "SR" Rack w/D20 Module	ETC "DRD" Rack w/D20 Module
Lutron "GP" Panel	Lutron Grafix Eye QS

ELV - Electronic Low Voltage (Reverse Phase) DIMMING (standard)

Utilizes specialized "ELV" dimmers. Best for New Construction applications

Notes:

- 120v & 277v
- Dims down to less than 5% light output (most cases)
- Consult Dimming manufacturer for installation instructions - DO NOT SHARE NEUTRALS!
- Must meet dimmer Minimum Load Requirements

Wiring Diagram

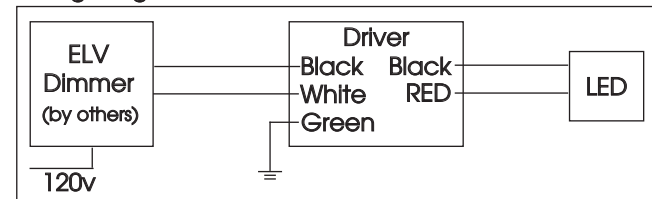

Compatible Dimmers

Wall Box (ELV Style)

Lutron "Diva"	Lutron "Vareo"
Lutron "Nova-T"	Lutron "Skylark"
Lutron "Maestro"	
Leviton "Surslide"	Leviton "Vizio"

Central System

ETC "SR" Rack w/ELV10 Module	ETC "DRD" Rack w/ELV10 Module
Lutron "GP" Panel with PHPM-PA Interface	Lutron Grafix Eye QS with PHPM-PA Interface

0-10V - DIMMING (-0-10V Option)

Integrates into a variety of building management and daylighting controls

Notes:

- 120v - 277v
- Dims down to less than 10% light output
- Requires interface to turn off power to driver
- Consult Dimming manufacturer for installation instructions - DO NOT SHARE NEUTRALS!

Wiring Diagram

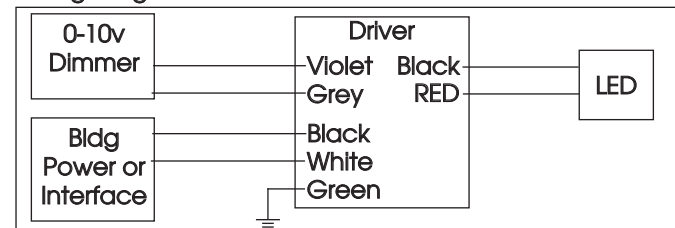

Compatible Dimmers

Wall Box

Lutron "Diva" - DVTV with PP-120H Interface	Leviton Renoir II 0-10v
---	-------------------------

Central System

Lutron Grafix Eye with GRX-TVI Interface
--

CYLINDRIX® III MINI

MULTIPLE SEMI-RECESSED 1 LIGHT LED

C3MSR-1
1LT LED



TYPE:



LUTRON HI-LUME / ECO-SYSTEM (-HILUME Option)

Integrates into a variety of building management and daylighting controls

Notes:

- 120v or 277v
- Dims down to less than 5% light output
- May use 3-Wire or Ecosystem Control
- Consult Dimming manufacturer for installation instructions - DO NOT SHARE NEUTRALS!

Compatible Dimmers

Wall Box (3-Wire Fluorescent)

DIVA
Maestro
Nova T
Vareo

Central System

Lutron ECO-System compatible controls
ETC "SR" Rack w/D20F Module
ETC "DRD" Rack w/D20F Module

3-Wire Wiring Diagram

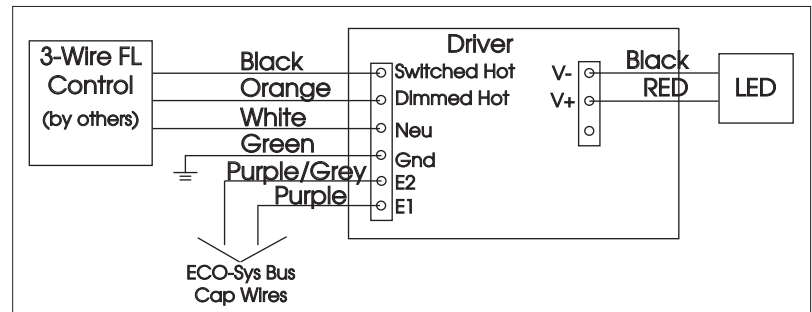

ECO System Digital Control Wiring

