

CLASSIX 6" DOWNLIGHT

6" ROUND DOWNLIGHT REMODELER LED

CLX-RD6-REM
LED



APPLICATION:

Retail, commercial & hospitality ambient lighting

CONSTRUCTION:

20 ga. galvanized steel frame
Passive cooling
Extruded aluminum heat sink

ELECTRICAL:

Electronic constant current LED driver, 120v or 277v input
ELV & Triac dimming standard, 120v or 277v

This product complies with IEEE C62.41 for surge endurance up to 2.5KV. Amerlux® recommends using additional surge protection with this unit (supplied by others), surge damage is not covered by warranty.

MOUNTING:

For use in sheet rock ceilings

OPTICS:

Spun aluminum semi-diffuse aperture cone
Spun aluminum upper reflector

LED:

Color Temp Options: 2700K, 3000K, 3500K, 4000K
CRI: 83 typ. (2700K, 3000K, 3500K, 4000K)
90+ typ. (2700K, 3000K)
CrispWhite LED available
R9 Values: 11 (83CRI), 55 (90+CRI)
Binning: 3 MacAdam
Life: 50,000 hrs
Lumen Maintenance: >70% of initial lumens @ 50,000 hrs
Lumen Output (3000K): up to 3607 lm; up to 79 lpw
CBCP (3000K): up to 19,788
Beam Options: Spot 15°, Flood 25°, Wide Flood 40°

LABELING:



Damp location
For indoor use only

PROJECT:

TYPE:



Electrostatic sensitive device,
observe precautions for
handling

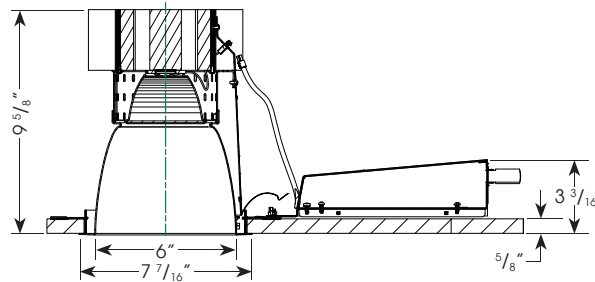
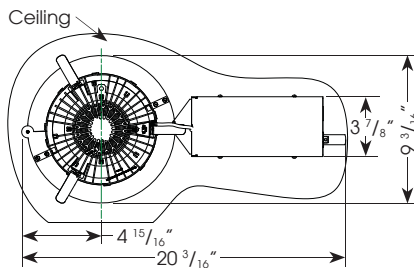

Ceiling Cut Out Dimension: 7" dia.

ELECTRICAL

Electronic driver

	25w		34w		45w		52w	
	System Watts	Amps	System Watts	Amps	System Watts	Amps	System Watts	Amps
120v	25	0.21	34	0.28	45	0.38	52	0.43
277v	25	0.09	34	0.12	45	0.16	52	0.19

ORDERING INFORMATION:

HOUSING:					REFLECTOR/LED OPTIC:			
Model	Wattage	Lamp Type	Voltage	Options	Model	Aperture Finish	Beam Spread	Color Temp (CCT(K)-CRI)
CLX-R6-REM	25	LED	120	0-10V - 0-10v dimming	CLX-RD6-REM	Reflector with white painted flange	SP - spot, 15°	27 - 2700-83
	34		277	HILUME - Lutron Hi-lume® dimming (25w & 34w only)		SDW - semi-diffuse white	FL - flood, 25°	30 - 3000-83
	45			DALI - DALI driver (25w, 34w, & 45w only)		Reflector with clear flange (flange finish matches cone finish)	WF - wide flood, 40°	35 - 3500-83
	52					SDC - semi-diffuse clear		40 - 4000-83
								279 - 2700-90+
								309 - 3000-90+
								CRISP - CrispWhite

Complete Unit Example: CLX-R6-REM-25-LED-120/CLX-RD6-REM-SDW-WF-30

Housing Example: CLX-R6-REM-25-LED-120

Reflector Example: CLX-RD6-REM-SDW-WF-30

Cat #:

Amerlux reserves the right to change details that do not affect overall function and performance.

CLASSIX 6" DOWNLIGHT

6" ROUND DOWNLIGHT REMODELER LED

CLX-RD6-REM
LED



TYPE:



FIXTURE DATA: For 34W data, multiply by 1.4; For 45W data, multiply by 1.8; see next pg for 52W data Complete photometric data (ies format) available upon request.
CCT Correction Factors: 2700-83 = 0.96; 3500-83 = 1.02; 4000-83 = 1.04; 2700-90+ = 0.80; 3000-90+ = 0.83; CRISP = 0.65

25W LED (3000K)

SPOT
DISTRIBUTION
LTL # 1026868

1970 lm, 79.0 lpw
11,136 CBCP

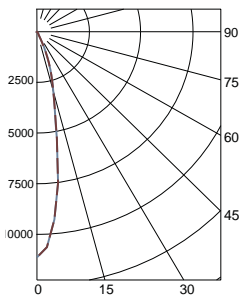

Candelas at Nadir	
Deg	Candela
0	11136
5	9304
15	2887
25	440
35	93
45	39

FLOOD
DISTRIBUTION
LTL # 1026867

1866 lm, 74.9 lpw
6290 CBCP

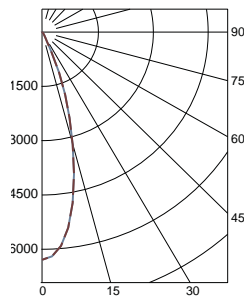

Candelas at Nadir	
Deg	Candela
0	6290
5	5927
15	3221
25	597
35	105
45	37

WIDE FLOOD
DISTRIBUTION
LTL # 1026866

1951 lm, 78.3 lpw
4,046 CBCP

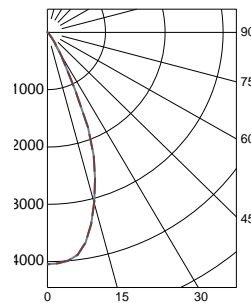

Candelas at Nadir	
Deg	Candela
0	4046
5	3998
15	3060
25	1114
35	197
45	37

APPLICATION DATA:

Notes and Definitions:

Beam spread is to 50% center beam candlepower (CBCP).
D=Distance to floor or wall.
FC=Footcandles on floor or wall at center beam aiming location.
L=Effective Visual Beam length in feet (50% of maximum footcandle level).
W=Effective Visual Beam width in feet (50% of maximum footcandle level).
CB=Distance across or down to center beam location.



		0° Aiming Angle Horizontal Footcandles			
		D	FC	L	W
SPOT	5.0'	444	1.6	1.6	
	7.5'	198	2.7	2.7	
	10.0'	112	3.4	3.4	
	12.5'	72	4.3	4.3	
FLOOD	5.0'	252	2.6	2.6	
	7.5'	112	3.8	3.8	
	10.0'	63	5.1	5.1	
	12.5'	41	6.4	6.4	
WIDE FLOOD	5.0'	162	3.5	3.5	
	7.5'	72	5.2	5.2	
	10.0'	41	7.0	7.0	
	12.5'	26	8.7	8.7	

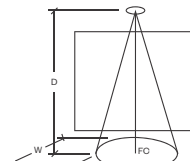

CLASSIX 6" DOWNLIGHT

6" ROUND DOWNLIGHT REMODELER LED

CLX-RD6-REM
LED



TYPE:



FIXTURE DATA: For 34W data, multiply 0.71; For 45W data, multiply 0.90; see previous pg for 25W data Complete photometric data (ies format) available upon request.
CCT Correction Factors: 2700-83 = 0.96; 3500-83 = 1.02; 4000-83 = 1.04; 2700-90+ = 0.80; 3000-90+ = 0.83; CRISP = 0.65

52W LED

SPOT
DISTRIBUTION
LTL # 1026865

3563 lm, 68.5 lpw
19,788 CBCP

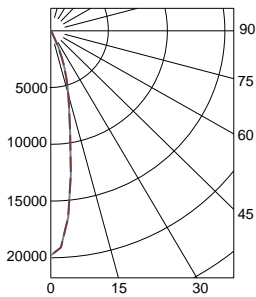

Candelas at Nadir	
Deg	Candela
0	19788
5	16499
15	5520
25	813
35	173
45	73

FLOOD
DISTRIBUTION
LTL # 1026863

3457 lm, 66.4 lpw
11,614 CBCP

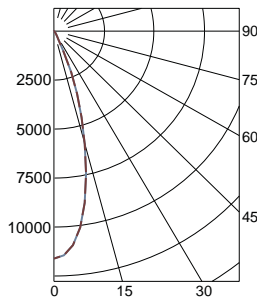

Candelas at Nadir	
Deg	Candela
0	11614
5	10971
15	5987
25	1089
35	193
45	68

WIDE FLOOD
DISTRIBUTION
LTL # 1026864

3607 lm, 69.3 lpw
7,373 CBCP

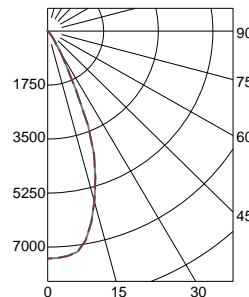

Candelas at Nadir	
Deg	Candela
0	7373
5	7315
15	5677
25	2088
35	350
45	70

APPLICATION DATA:

Notes and Definitions:

Beam spread is to 50% center beam candlepower (CBCP).
D=Distance to floor or wall.
FC=Footcandles on floor or wall at center beam aiming location.
L=Effective Visual Beam length in feet (50% of maximum footcandle level).
W=Effective Visual Beam width in feet (50% of maximum footcandle level).
CB=Distance across or down to center beam location.



	D	FC	L	W
SPOT	5.0'	790	1.6	1.6
	7.5'	352	2.7	2.7
	10.0'	198	3.4	3.4
	12.5'	127	4.1	4.1
FLOOD	5.0'	465	2.6	2.6
	7.5'	207	3.8	3.8
	10.0'	117	5.2	5.2
	12.5'	75	6.5	6.5
WIDE FLOOD	5.0'	296	3.5	3.5
	7.5'	132	5.3	5.3
	10.0'	74	7.0	7.0
	12.5'	48	8.9	8.9

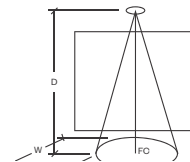

CLASSIX 6" DOWNLIGHT

6" ROUND DOWNLIGHT REMODELER LED

CLX-RD6-REM
LED



TYPE:



DIMMING COMPATIBILITY:

Amerlux® fixtures are compatible with all major dimming protocols prevalent in the United States. Please see below for general compatibilities and wiring diagrams. Amerlux recommends testing your unique dimming configuration as the exact full configuration (Dimmer, Fixture Quantity, Voltage, etc) may affect dimming performance.

ELV - Electronic Low Voltage (Reverse Phase) DIMMING (standard)

Utilizes specialized "ELV" dimmers. Best for New Construction applications

Notes:

- 120v or 277v
- Dims down to less than 5% light output (most cases)
- Consult Dimming manufacturer for installation Instructions - DO NOT SHARE NEUTRALS!
- Must meet dimmer Minimum Load Requirements

Wiring Diagram

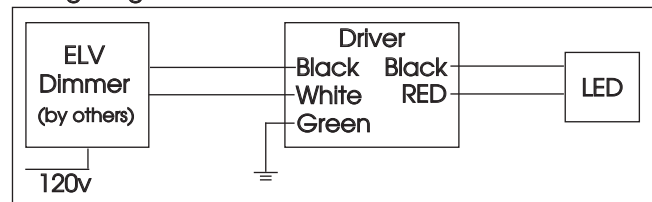

Compatible Dimmers

Wall Box (ELV Style)

Lutron "Diva"
Lutron "Nova-T"
Lutron "Maestro"
Leviton "Surslide"

Lutron "Vareo"
Lutron "Skylark"

Leviton "Vizio"

Central System

ETC "SR" Rack w/ELV10 Module
Lutron "GP" Panel with PHPM-PA Interface

ETC "DRD" Rack w/ELV10 Module
Lutron Grafix Eye QS with PHPM-PA Interface

TRIAC (Forward Phase) DIMMING (standard)

Utilizes "Standard" incandescent dimmers that are in wide use in installations across the US. Best for retrofit applications where Triac dimmers are installed.

Notes:

- 120v or 277v
- Dims down to less than 5% light output (most cases)
- Consult Dimming manufacturer for installation Instructions - DO NOT SHARE NEUTRALS!
- Must meet dimmer Minimum Load Requirements per dimming manufacturer

Wiring Diagram

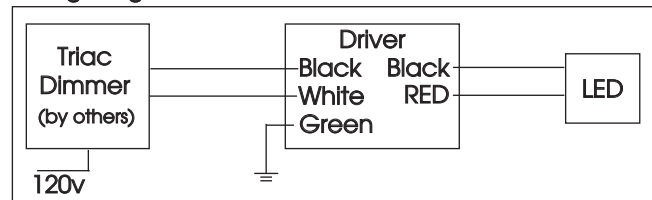

Compatible Dimmers

Wall Box (Incandescent Style, Wattage as required)

Lutron "Diva"
Lutron "Nova-T"
Lutron "Maestro"

Lutron "Vareo"
Lutron "Skylark"

Central System

ETC "SR" Rack w/D20 Module
Lutron "GP" Panel

ETC "DRD" Rack w/D20 Module
Lutron Grafix Eye QS

CLASSIX 6" DOWNLIGHT

6" ROUND DOWNLIGHT REMODELER LED

CLX-RD6-REM
LED



TYPE:



LUTRON HI-LUME / ECO-SYSTEM (-HILUME Option)

Integrates into a variety of building management and daylighting controls

Notes:

- 120v or 277v
- Dims down to less than 5% light output
- May use 3-Wire or Ecosystem Control
- Consult Dimming manufacturer for installation instructions - DO NOT SHARE NEUTRALS!

3-Wire Wiring Diagram

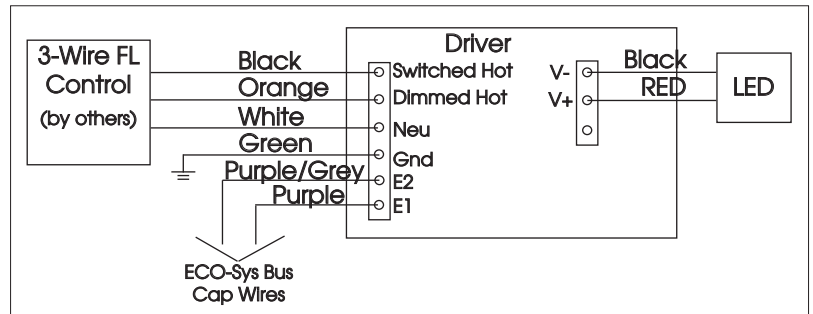

Compatible Dimmers

Wall Box (3-Wire Fluorescent)

DIVA
Maestro
Nova T
Vareo

Central System

Lutron ECO-System compatible controls
ETC "SR" Rack w/D20F Module
ETC "DRD" Rack w/D20F Module

ECO System Digital Control Wiring

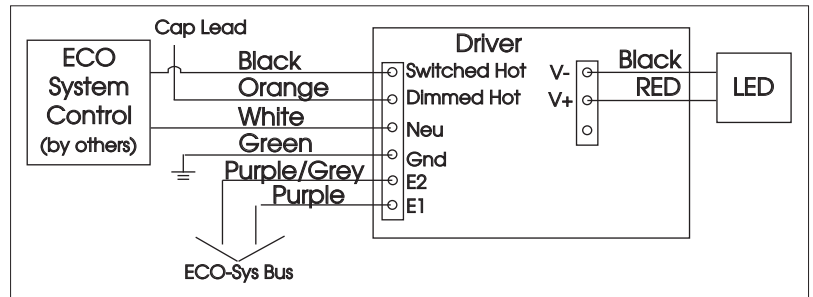

0-10V - DIMMING (-0-10V Option)

Integrates into a variety of building management and daylighting controls

Notes:

- 120v - 277v
- Dims down to 1% light output
- Requires interface to turn off power to driver
- Consult Dimming manufacturer for installation instructions - DO NOT SHARE NEUTRALS!

Wiring Diagram

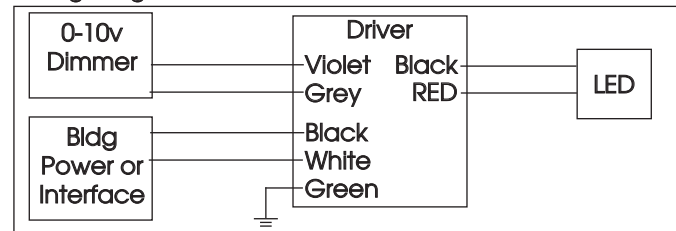

Compatible Dimmers

Wall Box

Lutron "Diva" - DVTV with PP-120H Interface

Leviton Renoir II 0-10v

Central System

Lutron Grafix Eye with GRX-TVI Interface