

# CLASSIX 6" ROUND LENSED WW

## 6" ROUND LENSED WALL WASH REMODELER LED

CLX-RLW6-REM  
LED

**APPLICATION:**

Commercial & hospitality wall wash lighting

**CONSTRUCTION:**

20 ga. galvanized steel frame  
Passive cooling  
Extruded aluminum heat sink

**ELECTRICAL:**

Electronic constant current LED driver, 120v or 277v input  
ELV & Triac dimming standard, 120v or 277v

**This product complies with IEEE C62.41 for surge endurance up to 2.5KV. Amerlux® recommends using additional surge protection with this unit (supplied by others), surge damage is not covered by warranty.**

**MOUNTING:**

For use in sheet rock ceilings

**OPTICS:**

Engineered nano technology lens provides transmission while concealing LED image  
Spun aluminum semi-diffuse aperture cone  
Wall wash beam distribution  
LED:

Color Temp Options: 2700K, 3000K, 3500K, 4000K  
CRI: 83 typ. (2700K, 3000K, 3500K, 4000K)

90+ typ. (2700K, 3000K)  
CrispWhite LED available  
R9 Values: 11 (83CRI), 55 (90+CRI)

Binning: 3 macAdam  
Life: 50,000 hrs  
Lumen Maintenance: >70% of initial lumens @ 50,000 hrs  
Lumen Output (3000): up to 3729 lm; up to 80 lpw

**LABELING:**



Damp location



PROJECT:  
  
TYPE:



(see website for details)

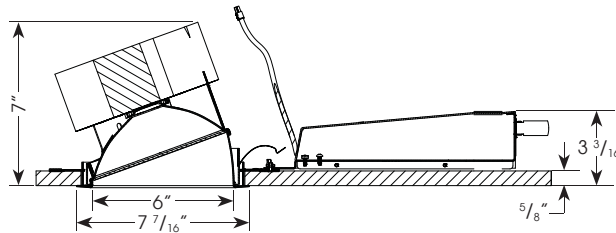
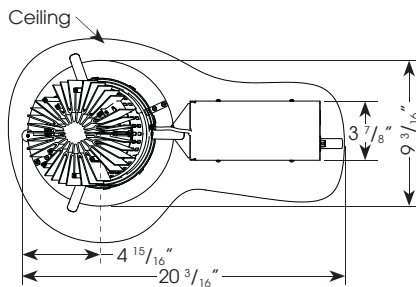

Ceiling Cut Out Dimension: 7" dia.

**ELECTRICAL**

Electronic driver

	25w		34w		45w		52w	
	System Watts	Amps	Systems Watts	Amps	Systems Watts	Amps	Systems Watts	Amps
120v	25	0.21	34	0.28	45	0.38	53	0.43
277v	25	0.09	34	0.12	45	0.16	53	0.19

**ORDERING INFORMATION:**

HOUSING:					REFLECTOR/LED OPTIC:		
Model	Wattage	Lamp Type	Voltage	Options	Model	Aperture Finish	Color Temp (CCT(K)-CRI)
CLX-R6-REM	25	LED	120	0-10V - 0-10v dimming	CLX-RLW6-REM	Reflector with white painted flange	27 - 2700-83
	34		277	HILUME - Lutron Hi-lume® dimming (25w & 34w only)		SDW - semi-diffuse white	30 - 3000-83
	45			DALI - DALI driver (25w, 34w, & 45w only)		Reflector with clear flange (flange finish matches cone finish)	35 - 3500-83
	52					SDC - semi-diffuse clear	40 - 4000-83
						279 - 2700-90+	
						309 - 3000-90+	
						CRISP - CrispWhite	

Complete Unit Example: CLX-R6-REM-34-LED-120/CLX-RLW6-REM-SDW-30

Housing Example: CLX-R6-REM-34-LED-120

Reflector Example: CLX-RLW6-REM-SDW-30

Cat #:

Amerlux® reserves the right to change details that do not affect overall function and performance.



# CLASSIX 6" ROUND LENSED WW

## 6" ROUND LENSED WALL WASH REMODELER LED

CLX-RLW6-REM  
LED



TYPE:



**FIXTURE DATA:** For 34W data, multiply by 52W data by 0.71; For 45W data, multiply 52W data by 0.90 Complete photometric data (ies format) available upon request.  
CCT Correction Factors: 2700-83 = 0.96; 3500-83 = 1.02; 4000-83 = 1.04; 2700-90+ = 0.80; 3000-90+ = 0.83; CRISP = 0.65

6" Round Lens Wall Washer LED  
Source: LED with frosted plastic optic  
Recessed

**25W LED (3000K)**  
LTL# 1031471  
1973 lm

**52W LED (3000K)**  
LTL# 1031469  
3729 lm

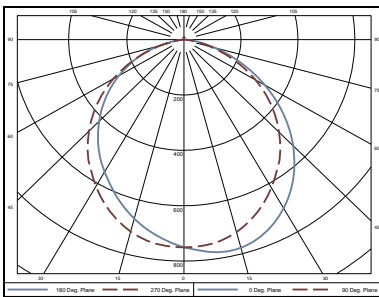

**ZONAL LUMEN SUMMARY**

Zone	Lumens	%Fixt
0-40	940	47.7
0-60	1624	82.3
0-90	1972	100.00
90-180	0	0.0

Luminaire Efficacy: 80.4 lm/wt

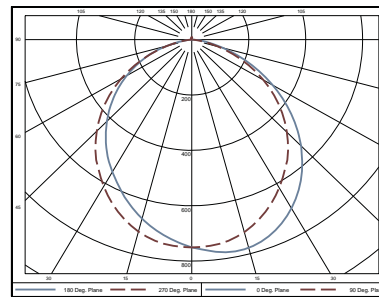

**ZONAL LUMEN SUMMARY**

Zone	Lumens	%Fixt
0-40	1179	47.7
0-60	3068	82.3
0-90	3729	100.00
90-180	0	0.0

Luminaire Efficacy: 72.1 lm/wt

**APPLICATION DATA:**

**Footcandles on Wall**

Footcandles are average and rounded off.  
Data for multiple units are based on a minimum of five units.

**25W LED (3000K)**

3 Feet From Wall

	← 4' →				← 4' →								
Distance from ceiling	8	9	10	9	8	9	10	9	8	9	10	9	8
0.5'	8	9	10	9	8	9	10	9	8	9	10	9	8
1.5'	25	27	30	27	25	27	30	27	25	27	30	27	25
2.5'	32	34	36	35	33	35	36	35	33	35	36	34	32
3.5'	29	31	32	32	31	32	33	32	31	32	32	31	30
4.5'	24	25	26	26	26	27	27	27	26	26	26	26	25
5.5'	20	20	21	21	22	22	22	22	22	21	21	20	20
6.5'	16	17	17	18	18	18	18	18	18	18	17	17	16
7.5'	13	14	14	15	15	15	15	15	15	15	14	14	13

**52W LED (3000K)**

3 Feet From Wall

	← 4' →				← 4' →								
Distance from ceiling	15	17	20	17	15	17	20	17	15	17	20	17	15
0.5'	15	17	20	17	15	17	20	17	15	17	20	17	15
1.5'	47	52	58	52	48	52	58	52	48	52	58	52	47
2.5'	60	64	68	66	63	66	69	66	63	66	68	65	61
3.5'	56	59	61	60	59	60	63	60	59	60	61	59	56
4.5'	46	48	50	50	49	51	51	51	49	50	50	48	47
5.5'	37	39	40	40	41	41	42	41	41	40	40	39	37
6.5'	30	31	33	33	33	34	34	34	34	33	33	31	30
7.5'	25	26	27	28	28	28	28	28	28	28	27	26	25

# CLASSIX 6" ROUND LENSED WW

6" ROUND LENSED WALL WASH REMODELER LED

CLX-RLW6-REM  
LED



TYPE:



## DIMMING COMPATIBILITY:

Amerlux® fixtures are compatible with all major dimming protocols prevalent in the United States. Please see below for general compatibilities and wiring diagrams. Amerlux recommends testing your unique dimming configuration as the exact full configuration (Dimmer, Fixture Quantity, Voltage, etc) may affect dimming performance.

### ELV - Electronic Low Voltage (Reverse Phase) DIMMING (standard)

Utilizes specialized "ELV" dimmers. Best for New Construction applications

#### Notes:

- 120v or 277v
- Dims down to less than 5% light output (most cases)
- Consult Dimming manufacturer for installation Instructions - DO NOT SHARE NEUTRALS!
- Must meet dimmer Minimum Load Requirements

#### Wiring Diagram

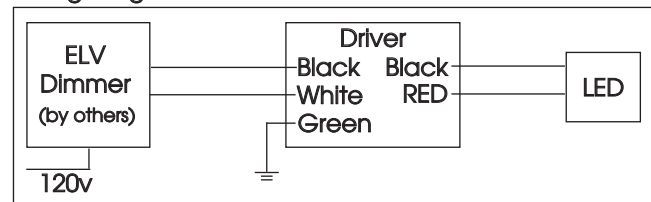

#### Compatible Dimmers

##### Wall Box (ELV Style)

Lutron "Diva"  
Lutron "Nova-T"  
Lutron "Maestro"  
Leviton "Surslide"

Lutron "Vareo"  
Lutron "Skylark"  
  
Leviton "Vizio"

##### Central System

ETC "SR" Rack w/ELV10 Module  
Lutron "GP" Panel with PHPM-PA Interface

ETC "DRD" Rack w/ELV10 Module  
Lutron Grafix Eye QS with PHPM-PA Interface

### TRIAC (Forward Phase) DIMMING (standard)

Utilizes "Standard" incandescent dimmers that are in wide use in installations across the US. Best for retrofit applications where Triac dimmers are installed.

#### Notes:

- 120v or 277v
- Dims down to less than 5% light output (most cases)
- Consult Dimming manufacturer for installation Instructions - DO NOT SHARE NEUTRALS!
- Must meet dimmer Minimum Load Requirements per dimming manufacturer

#### Wiring Diagram

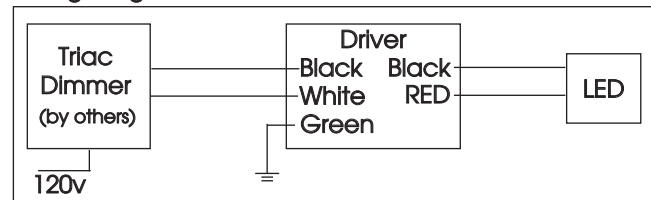

#### Compatible Dimmers

##### Wall Box (Incandescent Style, Wattage as required)

Lutron "Diva"  
Lutron "Nova-T"  
Lutron "Maestro"

Lutron "Vareo"  
Lutron "Skylark"

##### Central System

ETC "SR" Rack w/D20 Module  
Lutron "GP" Panel

ETC "DRD" Rack w/D20 Module  
Lutron Grafix Eye QS

# CLASSIX 6" ROUND LENSED WW

6" ROUND LENSED WALL WASH REMODELER LED

CLX-RLW6-REM  
LED



TYPE:



## LUTRON HI-LUME / ECO-SYSTEM (-HILUME Option)

Integrates into a variety of building management and daylighting controls

### Notes:

- 120v or 277v
- Dims down to less than 5% light output
- May use 3-Wire or Ecosystem Control
- Consult Dimming manufacturer for installation instructions - DO NOT SHARE NEUTRALS!

### 3-Wire Wiring Diagram

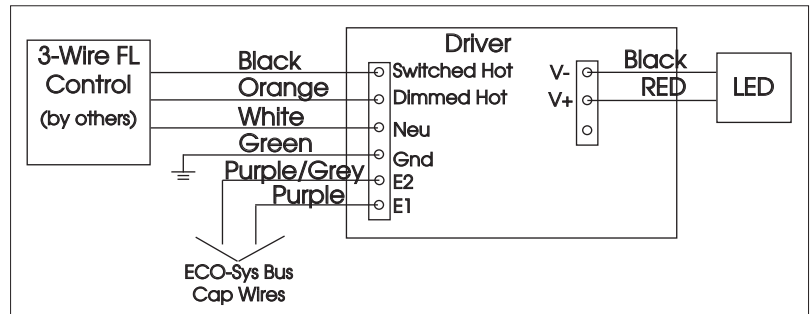

### Compatible Dimmers

#### Wall Box (3-Wire Fluorescent)

DIVA  
Maestro  
Nova T  
Vareo

#### Central System

Lutron ECO-System compatible controls  
ETC "SR" Rack w/D20F Module  
ETC "DRD" Rack w/D20F Module

### ECO System Digital Control Wiring

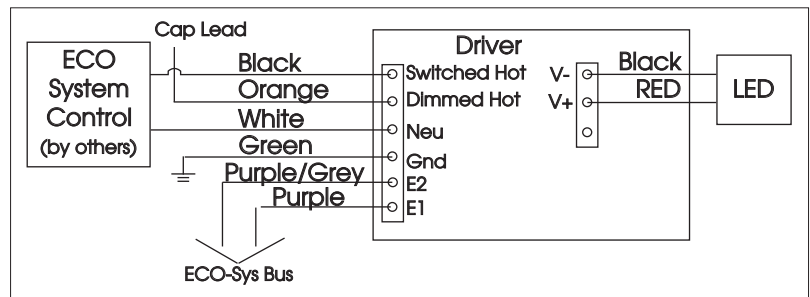

## 0-10V - DIMMING (-0-10V Option)

Integrates into a variety of building management and daylighting controls

### Notes:

- 120v - 277v
- Dims down to 1% light output
- Requires interface to turn off power to driver
- Consult Dimming manufacturer for installation instructions - DO NOT SHARE NEUTRALS!

### Wiring Diagram

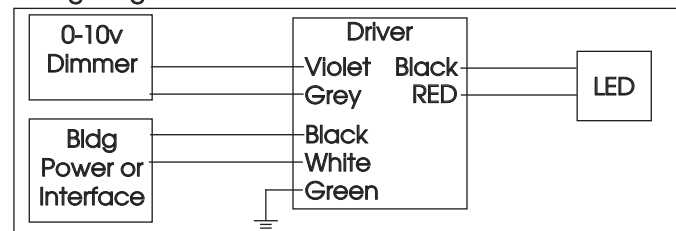

### Compatible Dimmers

#### Wall Box

Lutron "Diva" - DVTV with PP-120H Interface

Leviton Renoir II 0-10v

#### Central System

Lutron Grafix Eye with GRX-TVI Interface