

Producer

Linear LED



Features

The Producer is a linear LED pendant fixture. At 5 or 10 watts per foot, it features a high efficient 60° or 80° batwing distribution, providing the right amount of light for your shelving displays. For more general illumination applications, a symmetrical distribution is offered. Available in 2' - 8' (standard) run lengths, the Producer offers various color temperatures, an optional 20% uplight component, as well as 0-10V dimming. The Producer is ideal choice for aisle lighting or general lighting in supermarkets.

Product Overview

Type:	Direct, Symmetrical or Batwing Lens, Louver
Wattage:	5W/ft, 10W/ft (other wattages consult factory)
Lumen Output:	3,408 max; 77.3 Lm/W (10W, BAT60, 4ft fixture)
Color Temp:	2700K, 3000K, 3500K, 4000K
CRI:	83 typ. (2700K, 3000K, 3500K, 4000K)
Dimming:	0-10V, 1% dim (standard) Lutron Hi-lume® 2 wire (120V only) Lutron Hi-lume® EcoSystem, 1% dim, fade to off Lutron Hi-lume® 5 Series DALI dimming, 0.1% dim

PROJECT:

TYPE:

Fixture Summary *(see following pages for more information)*

Performance Chart

Wattage Per Foot	Delivered Lumens	LPW	Color Temp
5	2045	102	3500K
10	3408	77.3	3500K

*Data is based on 3500K-83 IES files available on website
Data is based on 4' fixture with 60° Batwing lens*

Runs

Individual Runs: 2' - 8' *(whole foot standard)*
Continuous Runs: Available *(whole foot standard)*

Electrical Data

Wattage Per Foot		4'		8'	
		System Watts	Amps	System Watts	Amps
5	120V	22.3	0.18	41.9	0.35
	277V	22.9	0.09	41.6	0.16
10	120V	42.1	0.35	84.2	0.70
	277V	41.5	0.15	83.0	0.30

Electronic multi-volt (120V-277V), constant current LED driver

Standard Patterns

"L"	"J"	"U"	"O"	"Z"	Wall to Ceiling	Custom*
Yes	Yes	Yes	Yes	Yes	No	Yes

**Submit drawing, consult factory*



Producer

Linear LED



PROJECT:

TYPE:

Ordering Information

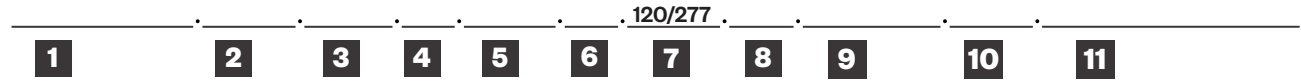

1 Model
PROD-A16†

2 Optics
BAT60 - batwing 60°
BAT80 - batwing 80°
DL - designer lens, symmetrical distribution

3 Mounting
ASW10 - through ceiling tile or gyp board, white, 10'
ASW20 - through ceiling tile or gyp board, white, 20'
ASB10 - through ceiling tile or gyp board, black, 10'
ASB20 - through ceiling tile or gyp board, black, 20'
ASW10T - over ceiling tee, white, 10'
ASW20T - over ceiling tee, white, 20'
ASB10T - over ceiling tee, black, 10'
ASB20T - over ceiling tee, black, 20'
1420P - mounting plate gripper with 1/4" -20 x 3/8" stud, power feed by others

4 Wattage (per foot)
Standard:
5 - 5W/ft
10 - 10W/ft
Optional:
3 - 3W/ft
4 - 4W/ft
6 - 6W/ft
7 - 7W/ft
8 - 8W/ft
9 - 9W/ft

5 Color Temp
83 CRI:
27 - 2700K-83
30 - 3000K-83
35 - 3500K-83
40 - 4000K-83
92 CRI optional, consult factory

6 Finish
HW - high reflectance matte white
BT - black texture
ST - silver texture
For other RAL color, consult factory

7 Voltage
120/277

8 Length

x		x	
(Length A)	(Length B)	(Length C)	
Length A (used for)	Length B (used for)	Length C (used for)	
- all patterns	- all patterns	- PU	
- IND	- PR - 2 lengths	- PZ	
- CON	of 2		

9 Configuration
IND¹ - individual fixture, 2' to 8' (5W minimum at 2')
CON - continuous run, > 8' in 1' increments
Standard Patterns (see page 5 for details):
PLL - L left, (2) straights + (1) 90° corner, leg right
PLR - L right, (2) straights + (1) 90° corner, leg left
PU - U shape, (3) straight lengths + (2) 90° corners
PR - rectangle, (4) straight lengths + (4) 90° corners
PZ - Z shape, (3) straight lengths + (2) 90° corners
Custom Patterns:
PC - please provide drawings and consult factory

10 Drivers
0-10V - 1% electronic dimming, multi-volt (120V-277V) constant current driver (standard)
HILUME-A-LTE - Lutron "A" Series, 1% dim, 2-wire, 120V only
HILUME-H-ECO - Lutron "H" Series, 1% dim, fade to off, EcoSystem
HILUME-5-ECO - Lutron "5" Series, EcoSystem
DALI - DALI Dimming 120V-277V, 0.1% dim

11 Options
LVRHW - straight blade louver, high reflectance white
LVRBT - straight blade louver, black texture
LVRST - straight blade louver, silver texture
(Louvers are used in conjunction with lens)
UL - uplight
EMW - emergency wireway
ENLS - Enlighted Sensor (0-10V driver only)
PF² - Extra power feed for emergency circuit or additional circuiting

1 - Lengths less than 4' may have restrictions based upon wattage, lengths, drivers or other options.

2 - Not available with IND (individual) configuration.

† The "A" refers to the sequential revision in a year and "XX" refers to the year of update. Updates coincide with improved performance while not changing the overall fixture aesthetic and are reflected in the published performance data. Please contact your Amerlux representative for explanations of changes.

PROJECT:

TYPE:

Specifications

Application

Pendant direct symmetric or batwing lens distribution for aisle, shelving or general ambient lighting. Optional 20% uplight component adds a feeling of volume to the space.

Construction

One piece extruded aluminum housing. Die-cast End Plates match fixture body finish. Die-formed, cold-rolled steel internal components are protected against rust and corrosion.

Optical

All lenses are snap-in, extruded acrylic, with a maximum length of 8'.
DL - Designer Lens provides flat even glow on lens. Best when lens is in direct or constant view. Such as vertical wall mounted.

BAT60 - 60° batwing distribution for wide light distribution.

BAT80 - 80° batwing distribution for very wide light distribution.

Optional:

LVR XX - Straight Blade Louver direct, fits over PL, BAT60, or BAT80 lenses for increased shielding.

HW - High reflectance White

BT - Black Textured

ST - Silver Textured

UL - Optional uplight component (12" every 4'-0"). Shares driver with downlight component and creates an 80% down/20% up fixture. (Wattage remains constant)

LED

Amerlux's boards and patented connector design with brand name LEDs enables Amerlux fixtures to have excellent thermal management and offer a 5 year warranty. Our LED binning is within 3 MacAdam ellipse. Boards are configured for maximum flexibility resulting in even illumination no matter what the fixture layout. LED boards are easily replaced in the field with just a Phillips screw driver.

Color Temperature Options:

2700K, 3000K, 3500K, 4000K

CRI: 83 typical, 92 optional - consult factory

R9: 16 @ CRI 83

R9: >50 @ CRI 92

Life: 50,000+ hr., > 70% of initial lumens (L70)

Electrical

Wiring: Individual and "Beginning of Run" (BOR) fixtures are prewired with power cord. All configurations have quick connect power harnesses for row connections.

Standard Wattage: 5W/ft, 10W/ft.

Optional Wattages: 3W/ft, 4W/ft, 6W/ft, 7W/ft, 8W/ft, 9W/ft. (3W & 4W have a minimum length of 4'). For other wattages consult factory. Emergency circuit via remote inverter or auxiliary emergency power supply (by others).

This product complies with IEEE C62.41 for surge endurance up to 2.5KV. Amerlux® recommends using additional surge protection with this unit (supplied by others), surge over voltage damage is not covered under warranty.

PF - Extra power feed for additional circuiting. Not available for individual (IND) configuration.

EMW - Emergency Wireway, separate wireway for emergency lighting.

Drivers

0-10V - 1% electronic dimming, multi-volt (120V-277V) constant current driver (standard). Cap leads for non-dim applications.

Optional Drivers:

HILUME-A-DH - Lutron "A" Series, 1% dim, 3-wire (Dim Hot)

HILUME-A-ECO - Lutron "A" Series, 1% dim, EcoSystem

HILUME-A-LTE - Lutron "A" Series, 1% dim, 2-wire, 120V only

HILUME-H-ECO - Lutron "H" Series, 1% dim, fade to off, EcoSystem

HILUME-5-ECO - Lutron "5" Series, EcoSystem

DALI - DALI Dimming 120V-277V, 0.1% dim

Finish

All painted surfaces are premium powder coated baked on for maximum durability and color stability.

HW - High reflective matte White

BT - Black Texture

ST - Silver Texture

For special paint colors supply RAL and/or actual paint chip for factory consultation.

Configurations/Lengths

IND - Individual fixtures are made of single standard lengths of 2 ft to 8 ft. These are stand alone fixtures with matching End Caps, supplied with the mounting hardware. Lengths less than 4' may have restrictions based upon wattage, lengths, drivers or other options.

CON - Continuous runs, > 8', specified to nearest whole foot length in 1' increments. Runs made from standard lengths have End Caps at the beginning and end of run. Runs > 60' may require second power feed. Each Housing has factory installed alignment pins. Mating fixtures are easily aligned and joined with "catch and latch" mechanism out of sight, on top of the Housing. Wiring is made fast and positive with molded quick connectors.

PXX - Standard Patterns consist of 90° corners with standard lengths (4' to 8' in 1' increments), continuous runs or made to measure lengths. Depending upon complexity of the pattern drawings may be required from the Customer. If ordering please give overall lengths.

A'-B'-PLL - L Left - (1) 90° Corner (*AC upper segment) 2 segments.

Specify overall segments: A' & B'

A'-B'-PLR - L Right - (1) 90° Corner (**AC lower segment) 2 segments.

Specify overall segments: A' & B'

A'-B'-PR - Rectangle - (4) 90° Corners joining 4 segments. Specify overall segments: A' & B'

A'-B'-C'-PU - U shape - (2) 90° Corners joining 3 segments. Specify overall segments: A', B', & C'

A'-B'-C'-PZ - Z shape - (2) 90° Corners joining 3 segments. Specify overall segments: A', B', & C'

See page 5 for layouts.

See page 5 for layouts.

See page 5 for layouts.

See page 5 for layouts.

See page 5 for layouts.

Please note: Corners are not lighted

Mounting

Intended to be pendant mounted Individual fixtures or in continuous rows. Standard or custom patterns consult factory

PROD-A16 - Direct pendant in center of ceiling tile or gypsum board ceiling (standard).

Cable Suspension: Cable is stranded stainless steel wire. All fittings are protected against rust and corrosion. Canopies are 5" x 1/4" die formed painted steel. Adjustment mechanism allows for infinite height adjustment. Amerlux recommends the required feed and non-feed suspensions based upon length and electrical options.

Certifications

Approved to UL standards for damp locations as tested by CSA.

Intended for indoor use only

Warranty

Amerlux's 5 year limited warranty. Please consult Amerlux website for details.

Producer

Linear LED



PROJECT:

TYPE:

PRODUCER

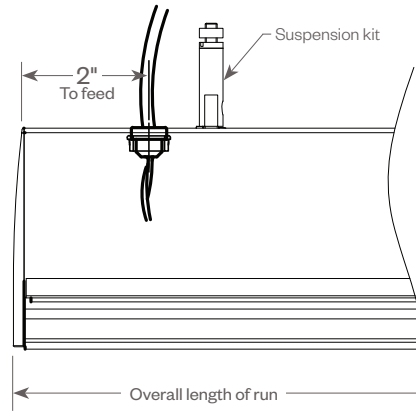
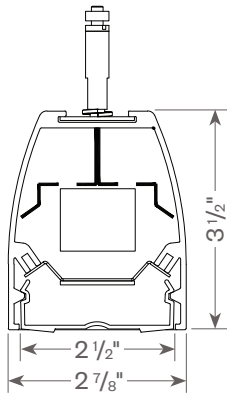

PRODUCER (WITH LOUVER)

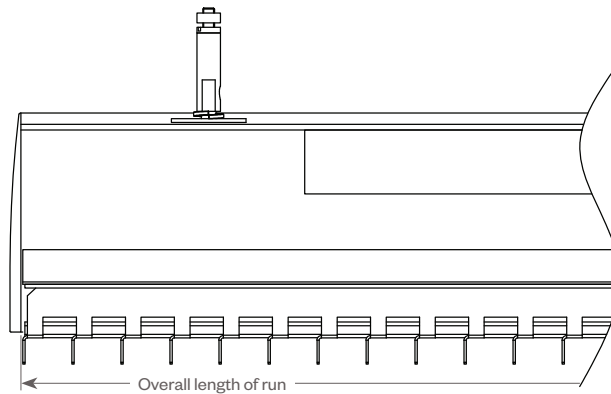
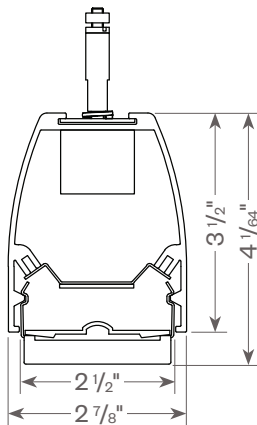

TOOLLESS JOINING

Line up the two housings by using the alignment pins. Secure them together by using the Catch & Latch System on the top on the extrusion.

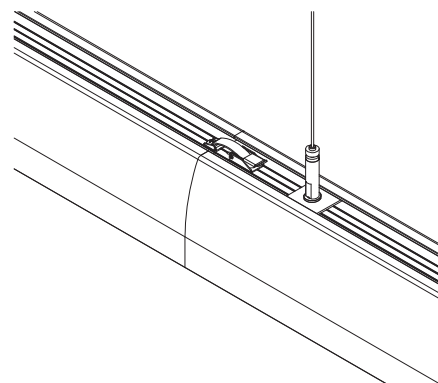
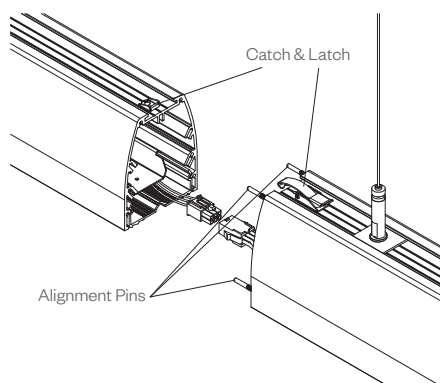

Producer

Linear LED



PROJECT:

TYPE:

OPTIONAL ENLIGHTED SENSOR:

Amerlux® and Enlighted have partnered to create building environments that are safer, and smarter, than ever before. At the heart of our partnership is Enlighted's Smart Sensor, the most advanced digital sensor available today. Integrated into Amerlux products, the sensor seamlessly collects and communicates dense data on building security, occupancy, performance, environmental conditions, ambient light levels, temperature, and energy consumption. This intelligence provides building managers with unprecedented guidance on cost savings and site-planning efficiencies. Enlighted Sensor (ENLS) is available with 0-10V driver only. Minimum run length is 4'. Enlighted power pack is provided with ENLS option.

4 FT OR 8 FT

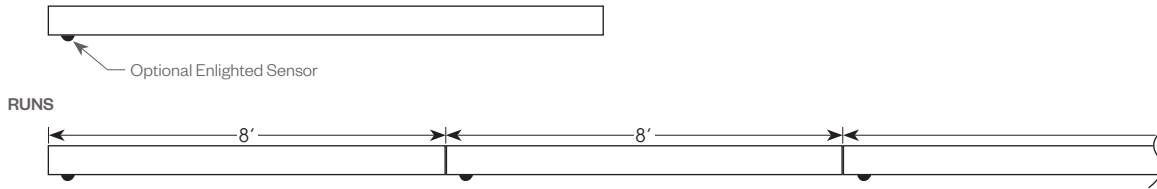

PRODUCER PATTERNS:

Standard Patterns

All corners are 90°, standard length legs of 7 3/16".
 Use standard lengths: 4' min to 8' in 1 foot increments.
 Continuous runs must be the same length in pairs for closed configuration.

Custom Patterns

Please provide drawings of your configuration.
 Made to Measure: +/- 1/8", consult factory.
 PC - custom pattern, please provide drawings and consult factory

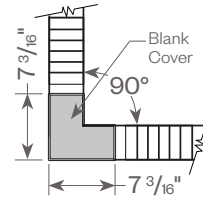

Producer Louver
 Butt Joint-Straight
 Blade Louver

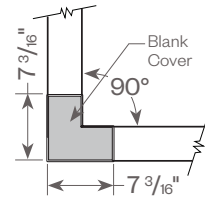

Producer Lens
 Mitered Lens

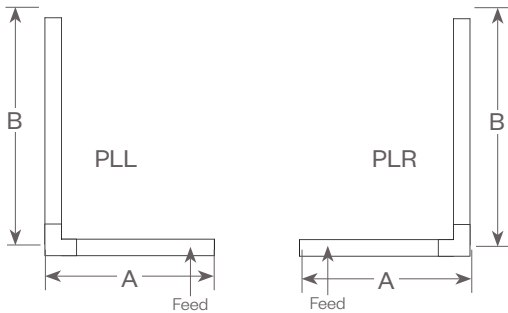

PLL - L Left, (2) straights + (1) 90° corner, leg right
PLR - L Right, (2) straights + (1) 90° corner, leg left
 Provide overall lengths: A' & B'
 Nomenclature: A-B-PLL A-B-PLR

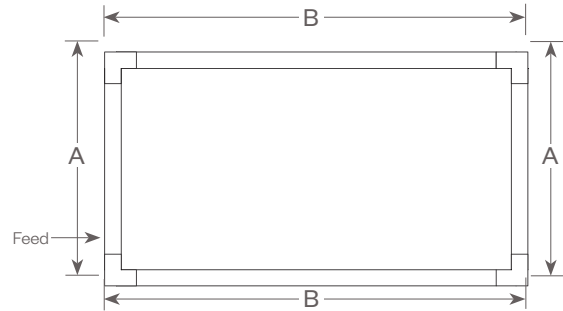

PR - Closed Rectangle, (4) straight lengths + (4) 90° corners
 Provide overall lengths: A' & B'
 Nomenclature: A-B-PR

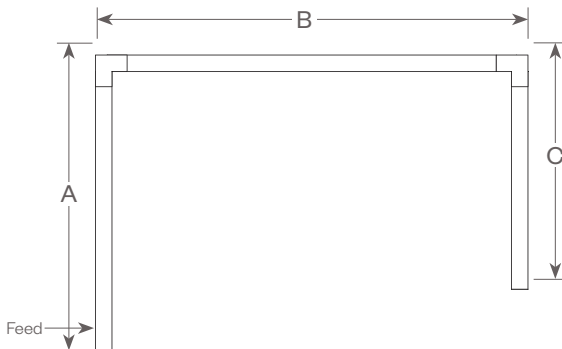

PU - Open U, (3) straight lengths + (2) 90° corners
 Provide overall lengths: A', B' & C'
 Nomenclature: A-B-C-PU

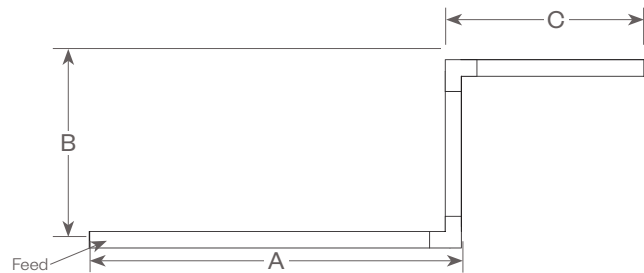

PZ - Open Z, (3) straight lengths + (2) 90° corners
 Provide overall lengths: A', B' & C'
 Nomenclature: A-B-C-PZ

Producer

Linear LED



PROJECT:

TYPE:

FIXTURE DATA: (Complete photometric data (.ies format) available upon request)

MULTIPLYING FACTORS: (Multiplying Factor is based on 3500K-83 120V IES file on website)

Wattage:	3W	4W	5W	6W	7W	8W	9W	10W
Factor:	0.36	0.46	0.56	0.66	0.76	0.85	0.93	1.0

CCT:	2700K-83	3000K-83	3500K-83	4000K-83
Factor:	0.93	1.0	1.08	1.15

PRODUCER DIRECT, BAT60, 10W 3000K 4FT

Total Watts: 41
Total Lumens: 4,370
Source: 128 White LED's

LTL# 1048968

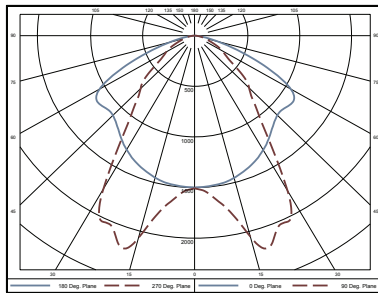

ZONAL LUMEN SUMMARY

Zone	Lumens	%Fixt
0-40	2494	57.1
0-60	3414	88.9
0-90	4370	100.00
90-180	0	0.00

Efficacy = 107.1 Lumens /Watt

COEFFICIENTS OF UTILIZATION

Effective Floor Cavity Reflectance 20%

RC	80			
RW	70	50	30	10
RCR				
0	5202	5202	5202	5202
1	4829	4653	4494	4352
2	4451	4139	3880	3663
3	4101	3693	3378	3126
4	3784	3312	2967	2704
5	3500	2987	2629	2364
6	3246	2708	2347	2088
7	3018	2467	2111	1860
8	2815	2259	1910	1670
9	2633	2078	1738	1509
10	2470	1920	1590	1371

Note: Values expressed as Lumens delivered to the task surface.

PRODUCER DIRECT, BAT80, 10W 3000K 4FT

Total Watts: 41
Total Lumens: 4,303
Source: 128 White LED's

LTL# 1048967

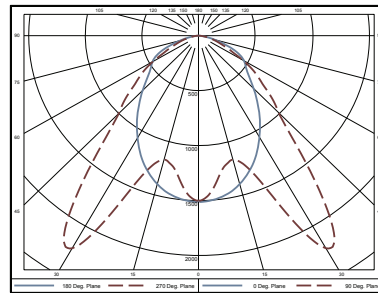

ZONAL LUMEN SUMMARY

Zone	Lumens	%Fixt
0-40	2075	48.2
0-60	3308	85.2
0-90	4303	100.00
90-180	0	0.00

Efficacy = 105.4 Lumens /Watt

COEFFICIENTS OF UTILIZATION

Effective Floor Cavity Reflectance 20%

RC	80			
RW	70	50	30	10
RCR				
0	5123	5123	5123	5123
1	4723	4535	4367	4215
2	4317	3984	3709	3478
3	3946	3513	3178	2912
4	3615	3116	2752	2473
5	3322	2782	2405	2127
6	3063	2500	2122	1850
7	2834	2259	1887	1626
8	2632	2054	1691	1441
9	2452	1878	1526	1288
10	2293	1725	1385	1159

Note: Values expressed as Lumens delivered to the task surface.

Producer

Linear LED



PROJECT:

TYPE:

FIXTURE DATA: (Complete photometric data (.ies format) available upon request)

MULTIPLYING FACTORS: (Multiplying Factor is based on 3500K-83 120V IES file on website)

Wattage:	3W	4W	5W	6W	7W	8W	9W
Factor:	0.63	0.82	1.0	1.17	1.34	1.50	1.64

CCT:	2700K-83	3000K-83	3500K-83	4000K-83
Factor:	0.87	0.93	1.0	1.08

PRODUCER, SYMMETRICAL, 5W 3500K 4FT

Total Watts: 20
Total Lumens: 1,487
Source: 128 White LED's

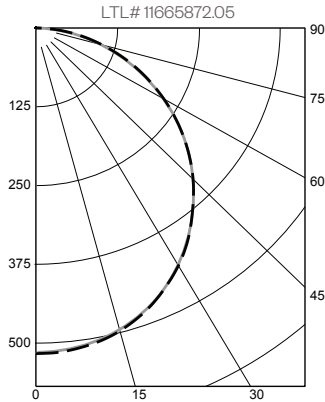

ZONAL LUMEN SUMMARY

Zone	Lumens	%Fixt
0-40	656	44.1
0-60	1157	77.8
0-90	1487	100.0
90-180	0	0.0

Luminaire Efficacy = 75.0 lm/w

COEFFICIENTS OF UTILIZATION

RC	80			
RW	70	50	30	10
RCR				
0	1729	1729	1729	1729
1	1572	1505	1446	1391
2	1424	1310	1215	1133
3	1296	1150	1035	942
4	1185	1019	895	799
5	1090	910	783	688
6	1006	820	693	600
7	934	744	619	530
8	870	680	558	473
9	813	624	506	426
10	763	577	463	386

Note: Values expressed as Lumens delivered to the task surface.

PRODUCER, SYMMETRICAL, 10W 3500K 4FT

Total Watts: 40
Total Lumens: 2,739
Source: 128 White LED's

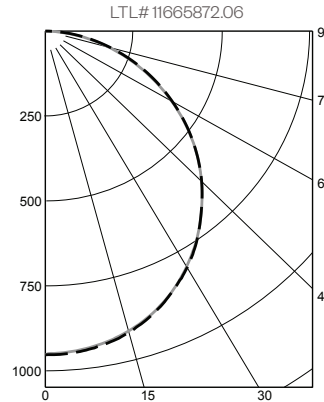

ZONAL LUMEN SUMMARY

Zone	Lumens	%Fixt
0-40	1211	44.2
0-60	2133	77.9
0-90	2739	100.0
90-180	0	0.0

Luminaire Efficacy = 68.7 lm/w

COEFFICIENTS OF UTILIZATION

RC	80			
RW	70	50	30	10
RCR				
0	3185	3185	3185	3185
1	2895	2774	2664	2564
2	2624	2414	2239	2089
3	2388	2119	1908	1738
4	2184	1877	1649	1473
5	2008	1678	1444	1268
6	1854	1512	1278	1107
7	1720	1372	1142	978
8	1603	1253	1029	873
9	1499	1151	934	785
10	1406	1063	853	712

Note: Values expressed as Lumens delivered to the task surface.

Producer

Linear LED



PROJECT:

TYPE:

DIMMING COMPATIBILITY:

Amerlux® Producer fixtures are compatible with all major dimming protocols prevalent in the United States. Please see below for general compatibilities and wiring diagrams. Amerlux recommends testing your unique dimming configuration as the exact full configuration (Dimmer, Fixture Quantity, Voltage, etc) may affect dimming performance.

--- NOTE: INFORMATION BELOW IS FOR WIRED DIMMERS ONLY. FOR WIRELESS DIMMERS, CONSULT FACTORY ---

0-10V - DIMMING (Standard)

Integrates into a variety of building management and daylighting controls

Notes:

- 120V or 277V*
- Dims down to 1% light output
- Requires interface to turn off power to driver
- Consult Dimming manufacturer for installation instructions - DO NOT SHARE NEUTRALS!

Compatible Dimmers†:

Wall Box

Lutron:	Wattstopper:	Leviton:
Diva - DVSTV	ADF-120277	Renoir II
Maestro - MS-Z101		
Nova-T - NTSTV-DV		

Center System

Lutron Grafik Eye with GRX-TV1 Interface

0-10V Wiring Diagram

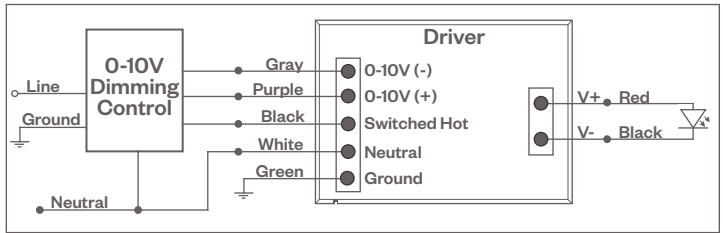

LUTRON HI-LUME DIMMING

Integrates into Lutron EcoSystem building management

Notes:

- 120V or 277V*
- Dims down to less than 5% light output
- EcoSystem Control
- Consult Dimming manufacturer for installation instructions - DO NOT SHARE NEUTRALS!

Compatible Dimmers†:

Wall Box (3-Wire Dimming)

Lutron:

Diva
Maestro
Nova-T
Vareo

Center System

Lutron EcoSystem compatible controls

HILUME-H-ECO, HILUME-5-ECO

EcoSystem Digital Control Wiring Diagram

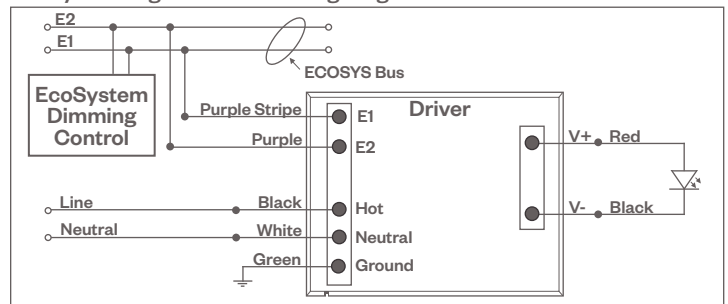

Notes:

* Driver is 277V dimmable with appropriate dimmer (by others). All provided wiring diagrams show 120V wiring colors and method.

Please refer to 277V dimmer installation instructions for 277V wiring diagrams.

† The absence of a dimmer from the lists above does not imply incompatibility. Please consult factory for compatibility inquiries.

Producer

Linear LED



PROJECT:

TYPE:

DIMMING COMPATIBILITY:

Amerlux® Producer fixtures are compatible with all major dimming protocols prevalent in the United States. Please see below for general compatibilities and wiring diagrams. Amerlux recommends testing your unique dimming configuration as the exact full configuration (Dimmer, Fixture Quantity, Voltage, etc) may affect dimming performance.

--- NOTE: INFORMATION BELOW IS FOR WIRED DIMMERS ONLY. FOR WIRELESS DIMMERS, CONSULT FACTORY ---

LUTRON HILUME-A-LTE DIMMING

Utilizes "Standard" incandescent dimmers that are in wide use in installations across the US. Best for retrofit applications where TRIAC dimmers are installed.

Notes:

- 120V only
- Dims down to less than 1% light output (most cases)
- Consult Dimming manufacturer for installation instructions - DO NOT SHARE NEUTRALS!
- Must meet dimmer Minimum Load Requirements per dimming manufacturer

Compatible Dimmers†:

Wall Box (Incandescent Style, Wattage as required)

Lutron:

- Diva
- Maestro
- Nova-T
- Vareo
- Skylark

Center System

- Lutron "GP" Panel
- Lutron Grafik Eye QS

Lutron HILUME-A-LTE Wiring Diagram

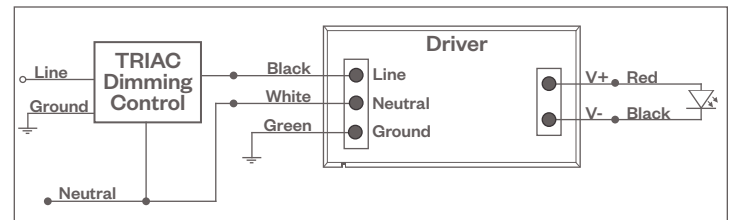

DALI - DALI DIMMING 120V-277V

Digital control protocol allows individual fixture control

Notes:

- 120V - 277V*
- Dims down to 0.1% light output in most cases

Compatible Dimmers†:

Wall Box

Leviton CD250 Controller

Center System

- Dynalite
- Fifth Light

DALI Wiring Diagram

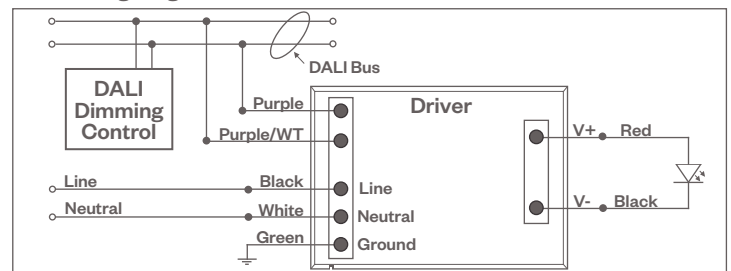

Notes:

* Driver is 277V dimmable with appropriate dimmer (by others). All provided wiring diagrams show 120V wiring colors and method. Please refer to 277V dimmer installation instructions for 277V wiring diagrams.

† The absence of a dimmer from the lists above does not imply incompatibility. Please consult factory for compatibility inquiries.