

# Rook® 350

## 3.5" Square Pendants



Pendant

### Features

High style, yet also versatile. Spare and modern, yet warm and welcoming. This striking Rook 350 re-imagines the Hornet HP Downlight line in a popular new pendant form. It's a fabulous solution for open ceilings, with the same aperture and drivers as Hornet HP Downlights—and yet its own distinctive style shines through. Rook 350 Pendant. Simply stunning.

### Product Overview

Type:	Square Pendant
Wattage:	11, 16, 18 (SD version) or 14, 21 (SLD version)
Lumen Output:	1,305 lm (SD), 1,732 lm (SLD)
CBCP:	up to 12,503 (SD), 4,763 (SLD)
Color Temp:	2200K, 2700K, 3000K, 3500K, 4000K
CRI:	83 typ. (2700K, 3000K, 3500K, 4000K) 90+ typ. (2200K, 2700K, 3000K, 3500K, 4000K)
	CrispWhite & Class A LED available
Dimming:	TRIAC & ELV (120V/277V) - 5% Dim Lutron Hi-lume® H Series/EcoSystem - 1% dim with soft on, fade to black, 120V/277V 0-10V (120V/277V) - 1% Dim

### PROJECT:

### TYPE:

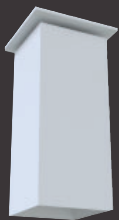

Surface Mount Pendant



Pendant w/Remote Driver

### Performance Chart

Watts	Delivered Lumens	LPW	CBCP	Color Temp
Rook 350 SD				
11	796	72.4	7,627	3000K-83
16	1,162	72.6	11,128	3000K-83
18	1,305	72.5	12,503	3000K-83
Rook 350 SLD				
14	1,160	82.9	3,191	3000K-83
21	1,732	82.5	4,763	3000K-83

Data is based on 3000K-83 IES files available on website  
See pages 5-6 for data on other beam spreads

### Electrical Data

	Rook 350 SD					
	11W		16W		18W	
	System Watts	Amps	System Watts	Amps	System Watts	Amps
120V	11	0.09	16	0.13	18	0.15
277V	11	0.04	16	0.06	18	0.06

	Rook 350 SLD			
	14W		21W	
	System Watts	Amps	System Watts	Amps
120V	14	0.12	21	0.18
277V	14	0.05	21	0.08

Electronic constant current LED driver



# Rook® 350

3.5" Square Pendants



## PROJECT:

## TYPE:

### Ordering Information

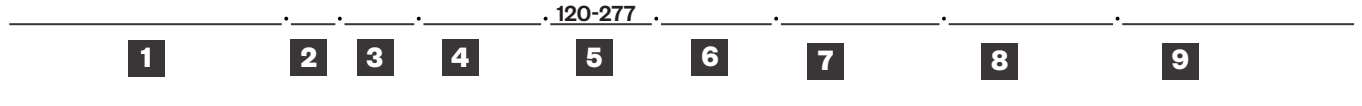

- 1** Model  
**RK350SD**  
**RK350SD-REMOTE** (Remote Driver)  
**RK350SLD** (Lensed)  
**RK350SLD-REMOTE** (Lensed, Remote Driver)

- 2** Wattage
- |                |                 |
|----------------|-----------------|
| <b>RK350SD</b> | <b>RK350SLD</b> |
| <b>11</b>      | <b>14</b>       |
| <b>16</b>      | <b>21</b>       |
| <b>18°</b>     |                 |
- ° Not available for use with CrispWhite color temp

- 3** Housing Finish  
**MW** - matte white  
**MB** - matte black  
**SLV** - matte silver

- 4** Mounting (matches housing finish)  
**CC4** - canopy/cord, 4' nominal OAL  
**CC8** - canopy/cord, 8' nominal OAL  
**CC12** - canopy/cord, 12' nominal OAL  
**RS4** - rigid stem, 4' nominal OAL  
**RS8** - rigid stem, 8' nominal OAL  
**SS4<sup>R</sup>** - swivel stem, 4' nominal OAL  
**SS8<sup>R</sup>** - swivel stem, 8' nominal OAL  
**SM<sup>R</sup>** - surface mount  
**CDCC4** - conduit canopy/cord, 4' nominal OAL  
**CDCC8** - conduit canopy/cord, 8' nominal OAL  
**CDCC12** - conduit canopy/cord, 12' nominal OAL  
**CDRS4** - conduit rigid stem, 4' nominal OAL  
**CDRS8** - conduit rigid stem, 8' nominal OAL  
**CDSM<sup>R</sup>** - conduit surface mount

<sup>R</sup> Not available for use with remote driver,  
 Consult factory for conduit mounting pricing  
 Cord and Stem mounts are field cuttable  
 For custom lengths, consult factory

- 5** Voltage  
**120-277**

- 6** Trim Finish  
**MW** - matte white  
**MB** - matte black  
**SLV** - matte silver

- 7** Beam Spreads
- |                                    |                                   |
|------------------------------------|-----------------------------------|
| <b>RK350SD</b>                     | <b>RK350SLD</b>                   |
| <b>SP</b> - spot, 15°              | <b>30SOL</b> - 30° solite lens    |
| <b>NF</b> - narrow flood, 20°      | <b>50SOL</b> - 50° solite lens    |
| <b>MFL</b> - medium flood, 24°     | <b>65SOL</b> - 65° solite lens    |
| <b>FL</b> - flood, 28°             | <b>75SAT</b> - 75° satin ice lens |
| <b>WF</b> - wide flood, 45°        |                                   |
| <b>VWF</b> - very wide flood, 60°  |                                   |
| <b>LS</b> - linear spread, 60°x10° |                                   |

- 8** Color Temp
- |                      |                        |                                       |
|----------------------|------------------------|---------------------------------------|
| <b>83 CRI</b>        | <b>90+ CRI</b>         |                                       |
| <b>27</b> - 2700K-83 | <b>229</b> - 2200K-90+ | <b>CRISP<sup>+</sup></b> - CrispWhite |
| <b>30</b> - 3000K-83 | <b>279</b> - 2700K-90+ | <b>3CLA</b> - 3K Class A              |
| <b>35</b> - 3500K-83 | <b>309</b> - 3000K-90+ |                                       |
| <b>40</b> - 4000K-83 | <b>359</b> - 3500K-90+ |                                       |
|                      | <b>409</b> - 4000K-90+ |                                       |
- \* Not available for 18W (SD model)*

- 9** Driver  
**LE/TE** - TRIAC/ELV dimming, 5% dim  
**0-10V** - 0-10V dimming, 1% dim  
**HILUME-H-ECO** - Lutron Hi-lume® H Series, EcoSystem, 1% dim with soft on, fade to black

# Rook® 350

3.5" Square Pendants



## PROJECT:

## TYPE:

### Specifications

#### Application

Retail and commercial ambient/task lighting

#### Construction

Extruded aluminum pendant housing  
Die-cast trim  
Extruded aluminum heat sink

#### Optical

**RK350SD Beam Spreads:**  
Spot, 15°; Narrow Flood, 22°; Medium Flood, 25°; Flood, 28°;  
Wide Flood, 45°; Very Wide Flood, 60°;  
Linear Spread, 60° x 10°  
**RK350SLD Beam Spreads:**  
Satin Ice Lens for maximum source concealment and wide distribution with a visually "hotter" aperture. 75° beam spread.  
Solite Lens for maximum efficacy and a visually quieter aperture. 30°, 50° & 65° beam spread options. Visually best with SLV reflector finish.

#### LED

**Color Temp Options:**  
2200K, 2700K, 3000K, 3500K, 4000K  
**CRI:** 83 typ. (2700K, 3000K, 3500K, 4000K)  
90+ typ. (2200K, 2700K, 3000K, 3500K, 4000K)  
CrispWhite\* LED available (16W max SD version)  
Class A\*\* 3000K LED available  
**R9 Values:** 11 (83 CRI), 55 (92 CRI)  
**Binning:** 3 MacAdam (SDCM)  
**Life:** 50,000+ hrs, > 70% of initial lumens at 50,000 hrs

*\*CrispWhite: CrispWhite Technology delivers the warmth of colors expected from a high 90 CRI solution but also creates the natural crisp white color that is pleasing to the eye. It creates the most impactful lighting ever available, by revealing the richest whites and vibrant colors that pop.*

*\*\*Class A LED: Class A LED's have a CRI > 80 and a GAI > 80. CRI defines color "Naturalness" and GAI defines color "Saturation." Both being high delivers rich colors and pure whites.*

#### Electrical

**Wattage:** 11, 16, 18 (SD version) or 14, 21 (SLD version)  
Electronic constant current LED driver, 120V-277V input  
**This product complies with IEEE C62.41 for surge endurance up to 2.5KV. Amerlux® recommends using additional surge protection with this unit (supplied by others), surge and over voltage damage is not covered under warranty.**

#### Drivers

LE/TE - Leading Edge, TRIAC, forward phase/Trailing Edge, ELV, reverse phase  
0-10V and Lutron also available  
*See pages 8-9 for more dimming information*

#### Finish

Powder coat paint  
*Consult factory for custom finishes*

#### Mounting

Canopy/cord, rigid stem, swivel stem (not available for use with remote driver) or surface mounting (not available for use with remote driver)  
Conduit mounting also available (see pg4 for details).  
Overall length (OAL) is field adjustable and factory set at ± 2" of nominal value.

#### Certifications

CSA tested to UL standards  
Indoor use only  
Damp location

#### Warranty

5 year limited warranty

# Rook® 350

3.5" Square Pendants



PROJECT:

TYPE:

### Canopy/Cord Mounting

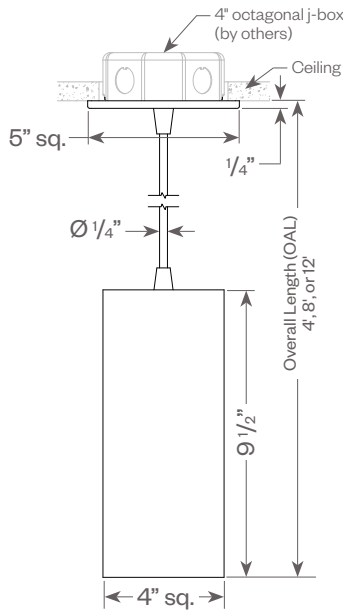

### Rigid Stem Mounting

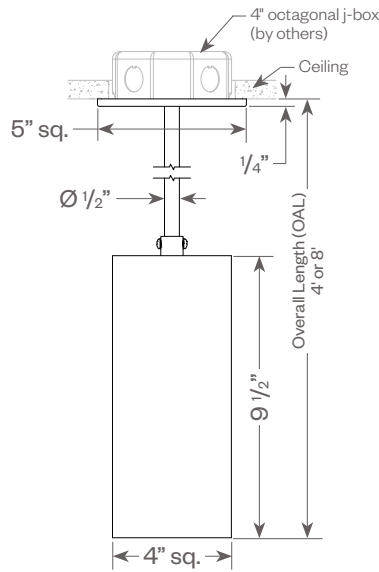

### Surface Mounting

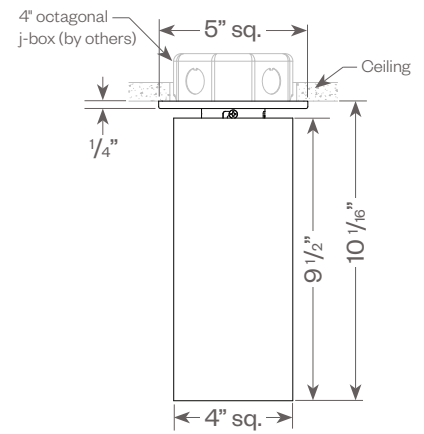

Ceiling Cut Out:  $\text{Ø}4\ 1/4"$

### Conduit Canopy/Cord Mounting

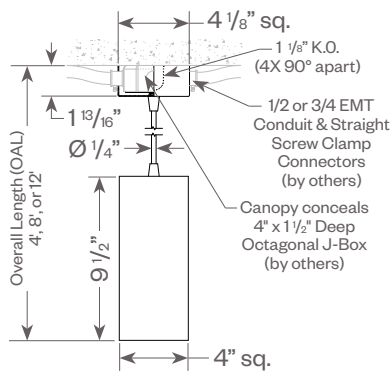

### Conduit Rigid Stem Mounting

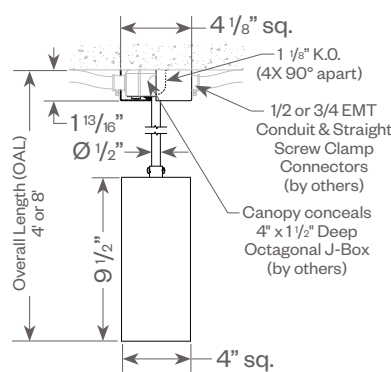

### Conduit Surface Mounting

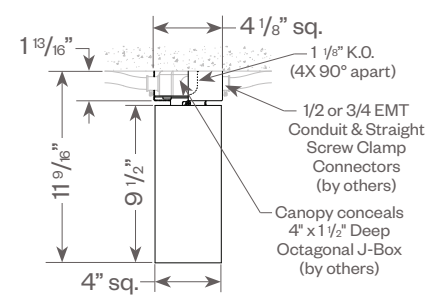

### Swivel Stem Mounting

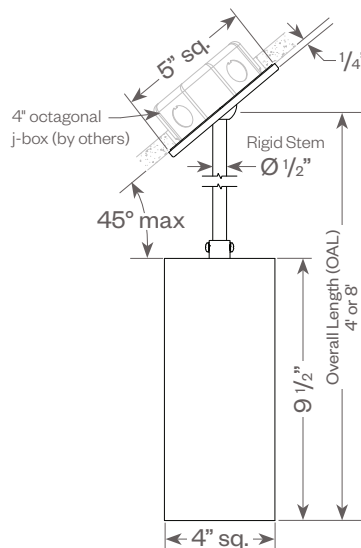

Ceiling Cut Out:  $\text{Ø}4\ 1/4"$

# Rook® 350

3.5" Square Pendants



PROJECT:

TYPE:

### Remote Driver Canopy/Cord Mounting

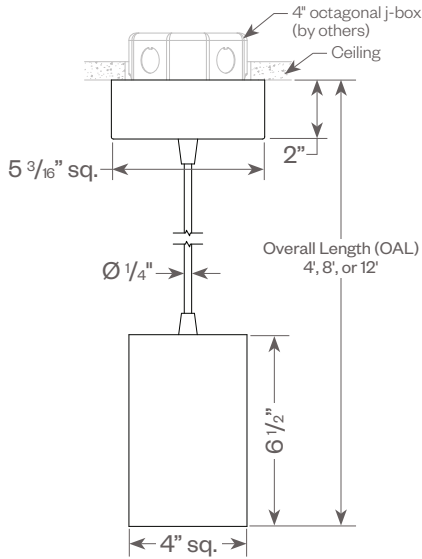

### Remote Driver Rigid Stem Mounting

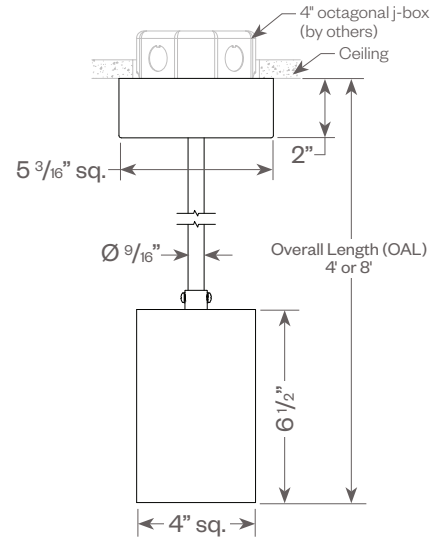

Ceiling Cut Out: Ø4 1/4"

### Remote Driver Conduit Canopy/Cord Mounting

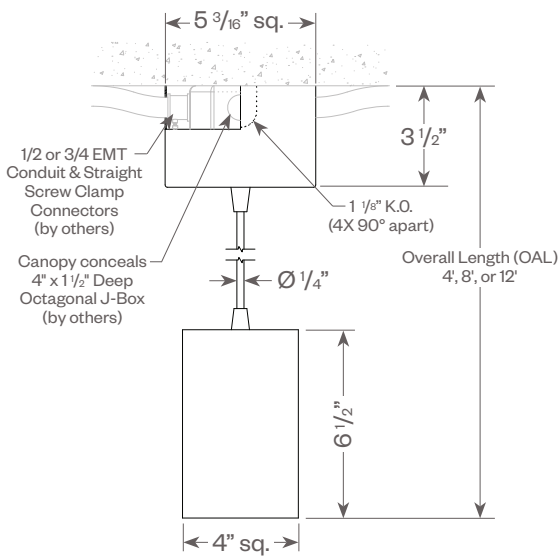

### Remote Driver Conduit Rigid Stem Mounting

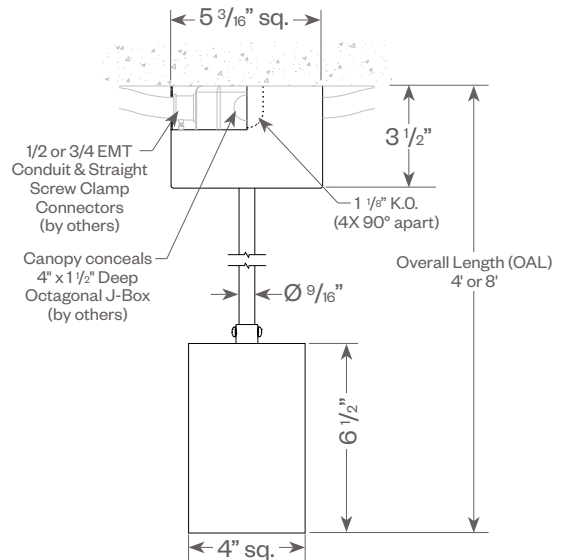

# Rook® 350

3.5" Square Pendants



**PROJECT:**

**TYPE:**

## RK350SD/RK350SD-REMOTE

**FIXTURE DATA:** (Complete photometric data (.ies format) available upon request)

**MULTIPLYING FACTORS:** (Multiplying Factor is based on 3000K-83 120V IES file on website)

Wattage:	11W	16W	18W
Factor:	0.61	0.89	1.0

CCT:	2700K-83	3000K-83	3500K-83	4000K-83
Factor:	0.96	1.0	1.02	1.04

CCT:	2200K-90+	2700K-90+	3000K-90+	3500K-90+	4000K-90+	CRISP*	3CLA
Factor:	0.71	0.80	0.83	0.87	0.90	0.65	0.75

\* Not available for use with 18W

### 18W LED, 3000K-83

**Spot (SP) Distribution, 15°**  
LTL #818202  
Lumens: 1,305

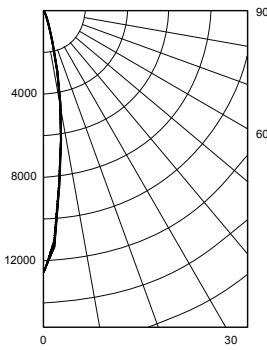

Candelas at Nadir	
Deg	Candela
0	12503
5	8267
15	1659
25	185
35	34
45	2

**Narrow Flood (NF) Distribution, 22°**  
LTL #818203  
Lumens: 1,216

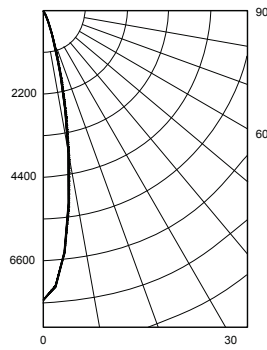

Candelas at Nadir	
Deg	Candela
0	7621
5	6414
15	1904
25	282
35	49
45	4

**Flood (FL) Distribution, 28°**  
LTL # 818205  
Lumens: 1,170

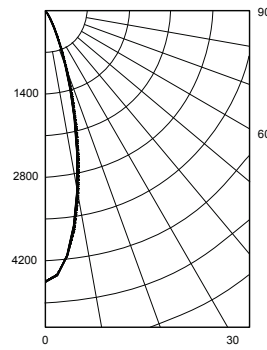

Candelas at Nadir	
Deg	Candela
0	4540
5	4130
15	2019
25	490
35	81
45	5

**Wide Flood (WF) Distribution, 45°**  
LTL # 818206  
Lumens: 1,166

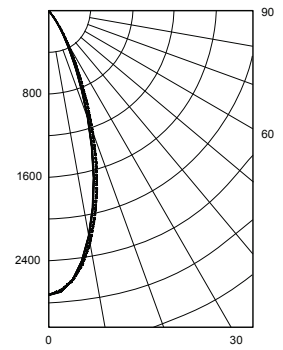

Candelas at Nadir	
Deg	Candela
0	2721
5	2581
15	1751
25	712
35	161
45	7

### Application Data:

		0° Aiming Angle Horizontal Footcandles			
		D	FC	L	W
Spot	5.0'	290	1.9	1.9	
	7.5'	161	2.6	2.6	
	10.0'	101	3.1	3.1	
	12.5'	69	3.7	3.7	
Narrow Flood	5.0'	219	2.2	2.2	
	7.5'	114	3.0	3.0	
	10.0'	69	3.8	3.8	
	12.5'	45	4.7	4.7	
Flood	5.0'	141	2.7	2.7	
	7.5'	70	3.7	3.7	
	10.0'	42	4.9	4.9	
	12.5'	27	6.0	6.0	
Wide Flood	5.0'	97	3.3	3.3	
	7.5'	46	4.8	4.8	
	10.0'	26	6.3	6.3	
	12.5'	17	7.7	7.7	

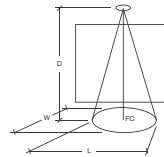

**Notes and Definitions:**

- Beam spread is to 50% center beam candlepower (CBCP).
- D=Distance to floor or wall.
- FC=Footcandles on floor or wall at center beam aiming location.
- L=Effective Visual Beam length in feet (50% of maximum footcandle level).
- W=Effective Visual Beam width in feet (50% of maximum footcandle level).
- CB=Distance across or down to center beam location.

# Rook® 350

3.5" Square Pendants



**PROJECT:**

**TYPE:**

## RK350SLD/RK350SLD-REMOTE

**FIXTURE DATA:** (Complete photometric data (.ies format) available upon request)

**MULTIPLYING FACTORS:** (Multiplying Factor is based on 3000K-83 120V IES file on website)

<b>Wattage:</b>	<b>14W</b>	<b>21W</b>
Factor:	0.67	1.0

<b>CCT:</b>	<b>2700K-83</b>	<b>3000K-83</b>	<b>3500K-83</b>	<b>4000K-83</b>
Factor:	0.96	1.0	1.02	1.04

<b>CCT:</b>	<b>2200K-90+</b>	<b>2700K-90+</b>	<b>3000K-90+</b>	<b>3500K-90+</b>	<b>4000K-90+</b>	<b>CRISP</b>	<b>3CLA</b>
Factor:	0.71	0.80	0.83	0.87	0.90	0.65	0.75

### 21W LED, 3000K-83

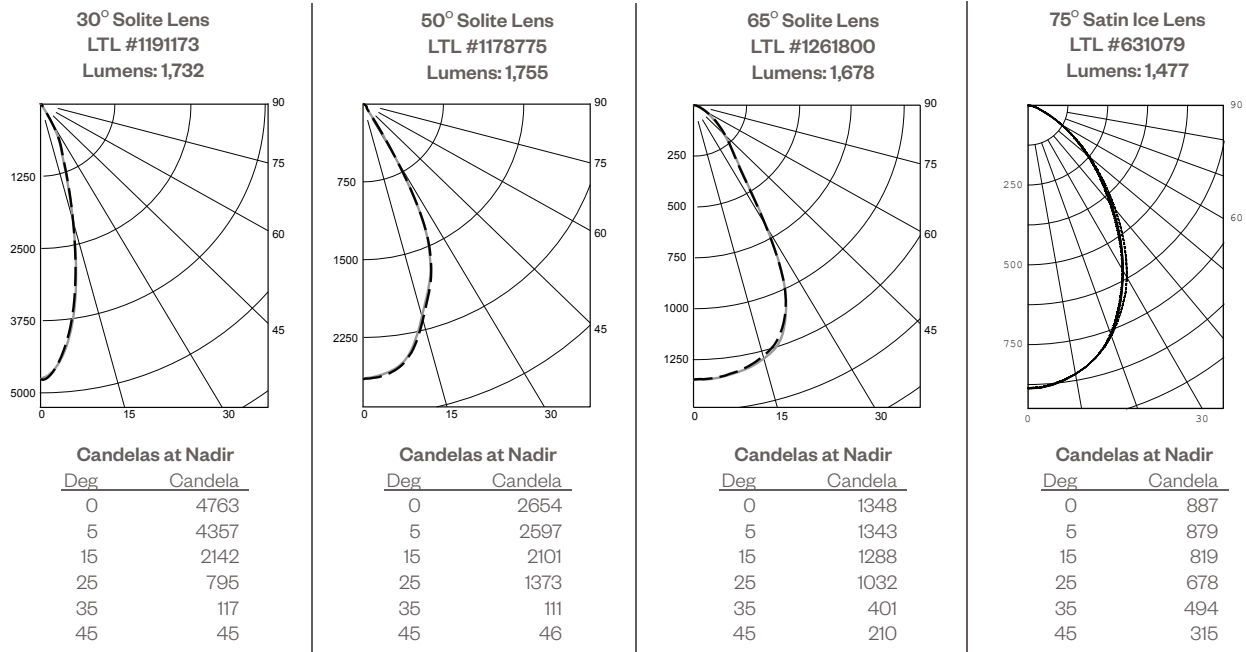

### Application Data:

**Notes and Definitions:**

Beam spread is to 50% center beam candlepower (CBOP).

**D**=Distance to floor or wall.

**FC**=Footcandles on floor or wall at center beam aiming location.

**L**=Effective Visual Beam length in feet (50% of maximum footcandle level).

**W**=Effective Visual Beam width in feet (50% of maximum footcandle level).

**CB**=Distance across or down to center beam location.

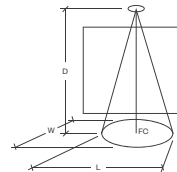

**30° Solite Lens**  
0° Aiming Angle  
Horizontal Footcandles

D	FC	L	W
5.0'	191	2.5	2.5
7.5'	85	3.5	3.5
10.0'	48	4.7	4.7
12.5'	31	5.9	5.9

**50° Solite Lens**  
0° Aiming Angle  
Horizontal Footcandles

D	FC	L	W
5.0'	107	4.0	4.0
7.5'	48	6.0	6.0
10.0'	27	8.1	8.1
12.5'	17	10.1	10.1

**65° Solite Lens**  
0° Aiming Angle  
Horizontal Footcandles

D	FC	L	W
5.0'	54	4.9	4.9
7.5'	24	7.5	7.5
10.0'	14	10.2	10.2
12.5'	9	12.8	12.8

**75° Satin Ice Lens**  
0° Aiming Angle  
Horizontal Footcandles

D	FC	L	W
5.0'	34	5.4	5.4
7.5'	16	8.1	8.1
10.0'	9	10.9	10.9
12.5'	6	14.0	14.0

# Rook® 350

3.5" Square Pendants



## PROJECT:

## TYPE:

### DIMMING COMPATIBILITY:

Amerlux® Rook fixtures are compatible with all major dimming protocols prevalent in the United States. Please see below for general compatibilities and wiring diagrams. Amerlux recommends testing your unique dimming configuration as the exact full configuration (Dimmer, Fixture Quantity, Voltage, etc) may affect dimming performance.

**--- NOTE: INFORMATION BELOW IS FOR WIRED DIMMERS ONLY. FOR WIRELESS DIMMERS, CONSULT FACTORY ---**

### TRIAC (Forward Phase) DIMMING (Standard)

Utilizes "Standard" incandescent dimmers that are in wide use in installations across the US. Best for retrofit applications where TRIAC dimmers are installed.

#### Notes:

- 120V or 277V\*
- Dims down to less than 5% light output (most cases)
- Consult Dimming manufacturer for installation instructions - DO NOT SHARE NEUTRALS!
- Must meet dimmer Minimum Load Requirements per dimming manufacturer

TRIAC Wiring Diagram

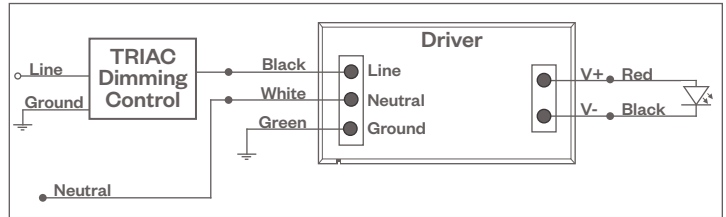

#### Compatible Dimmers†:

Wall Box (Incandescent Style, Wattage as required)		Central System
Lutron "Diva"	Lutron "Vareo"	Lutron "GP" Panel
Lutron "Nova-T"	Lutron "Skylark"	Lutron Grafik Eye QS
Lutron "Maestro"		

### ELV - Electronic Low Voltage (Reverse Phase) DIMMING (Standard)

Utilizes specialized "ELV" dimmers.

#### Notes:

- 120V or 277V\*
- Dims down to less than 5% light output (most cases)
- Consult Dimming manufacturer for installation instructions - DO NOT SHARE NEUTRALS!
- Must meet dimmer Minimum Load Requirements

ELV Wiring Diagram

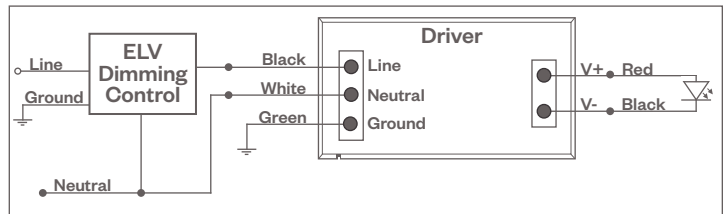

#### Compatible Dimmers†:

Wall Box (ELV Style)		Central System
Lutron "Diva"	Leviton "Surslide"	Lutron "GP" Panel with PHPM-PA Interface
Lutron "Nova-T"	Leviton "Vizio"	Lutron Grafik Eye QS with PHPM-PA Interface
Lutron "Maestro"		
Lutron "Vareo"		
Lutron "Skylark"		

### 0-10V - DIMMING (-0-10V Option)

Integrates into a variety of building management and daylighting controls

#### Notes:

- 120V or 277V\*
- Dims down to 1% light output
- Requires interface to turn off power to driver
- Consult Dimming manufacturer for installation instructions - DO NOT SHARE NEUTRALS!

0-10V Wiring Diagram

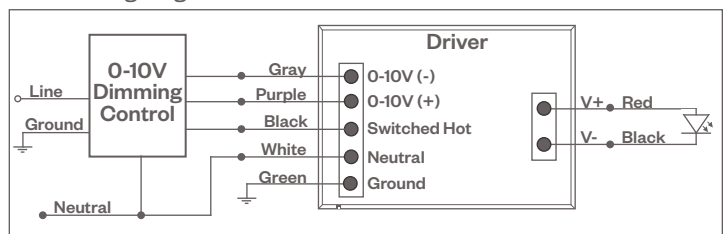

#### Compatible Dimmers†:

Wall Box	Central System
Lutron "Diva" - DVTV with PP-120H Interface	Leviton Renoir II 0-10V
	Lutron Grafik Eye with GRX-TVI Interface

#### Notes:

\* Driver is 277V dimmable with appropriate dimmer (by others). All provided wiring diagrams show 120V wiring colors and method. Please refer to 277V dimmer installation instructions for 277V wiring diagrams.

† The absence of a dimmer from the lists above does not imply incompatibility. Please consult factory for compatibility inquiries.



# Rook® 350

3.5" Square Pendants



**PROJECT:**

**TYPE:**

**DIMMING COMPATIBILITY:**

Amerlux® Rook fixtures are compatible with all major dimming protocols prevalent in the United States. Please see below for general compatibilities and wiring diagrams. Amerlux recommends testing your unique dimming configuration as the exact full configuration (Dimmer, Fixture Quantity, Voltage, etc) may affect dimming performance.

**--- NOTE: INFORMATION BELOW IS FOR WIRED DIMMERS ONLY. FOR WIRELESS DIMMERS, CONSULT FACTORY ---**

**LUTRON H-SERIES / ECOSYSTEM (-HILUME-H-ECO Option)**

Integrates into Lutron EcoSystem building management

**Notes:**

- 120V or 277V\*
- Dims down to 1% light output
- EcoSystem Control
- Consult Dimming manufacturer for installation instructions - DO NOT SHARE NEUTRALS!

**Compatible Dimmers†:**

Wall Box	Central System
Lutron "Diva"	Lutron EcoSystem compatible controls
Lutron "Nova-T"	
Lutron "Maestro"	
Lutron "Vareo"	

**HILUME-H-ECO, HILUME-5-ECO  
EcoSystem Digital Control Wiring Diagram**

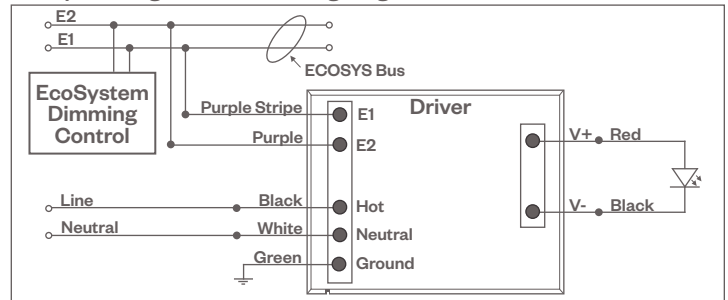

**Notes:**

- \* Driver is 277V dimmable with appropriate dimmer (by others). All provided wiring diagrams show 120V wiring colors and method. Please refer to 277V dimmer installation instructions for 277V wiring diagrams.
- † The absence of a dimmer from the lists above does not imply incompatibility. Please consult factory for compatibility inquiries.