

WALL BRACKETS

All wall brackets are constructed of corrosion resistant cast aluminum (A319 Alloy).

All brackets have a nominal 3" OD tenon for luminaire mounting, and four holes in the back plate for mounting to the wall. (Wall mounting hardware is not included, due to the wide variety of backing materials. Customer should determine the appropriate anchoring hardware based on the wall material.)

Ordering Information

Model	Finish
WBR02	ATC
WBR04	BLK
WBR05	CLB
WBR07	GRN
WBR08D	GTG
WBR08U	TBK
WBR09	WHT

Finish

The bracket will be finished with a premium quality thermoset polyester powdercoat for a durable finish.

Standard:

Premium:

GRN - Green

GTG - Granite Green

CLB - Classic Bronze

ATC - Antique Copper

TBK - Textured Black

WHT - White

BLK - Satin Black

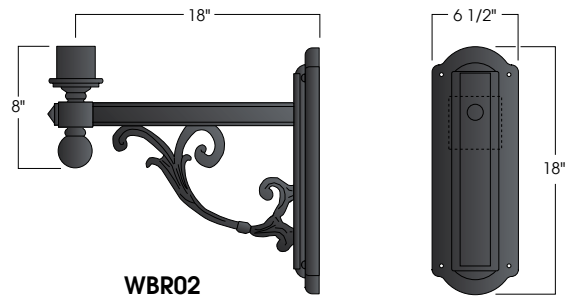

WBR02

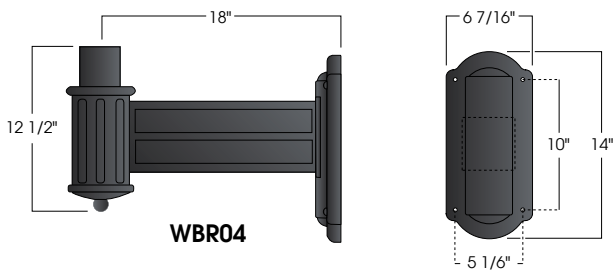

WBR04

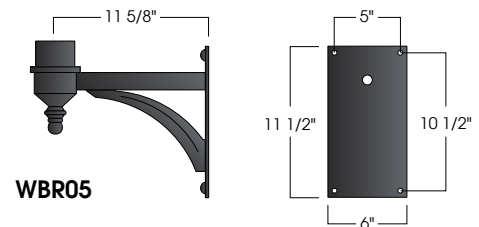

WBR05

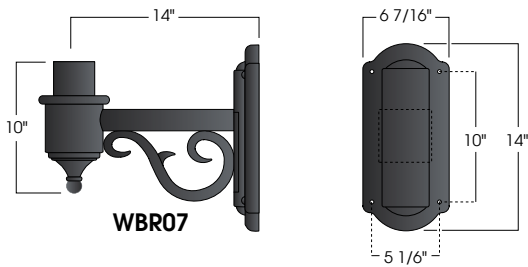

WBR07

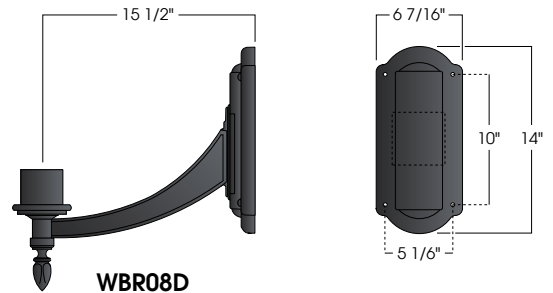

WBR08D

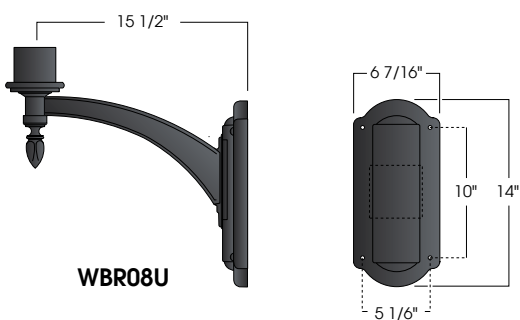

WBR08U

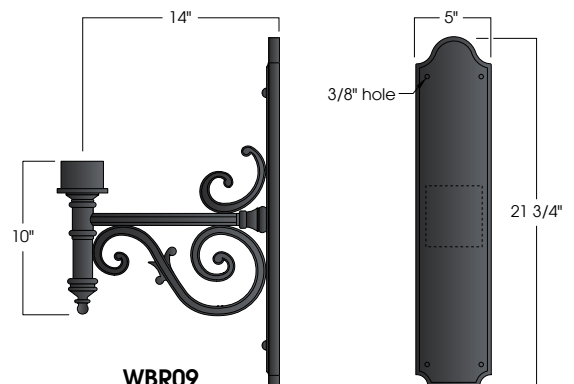

WBR09